

Pánské pracovní kalhoty

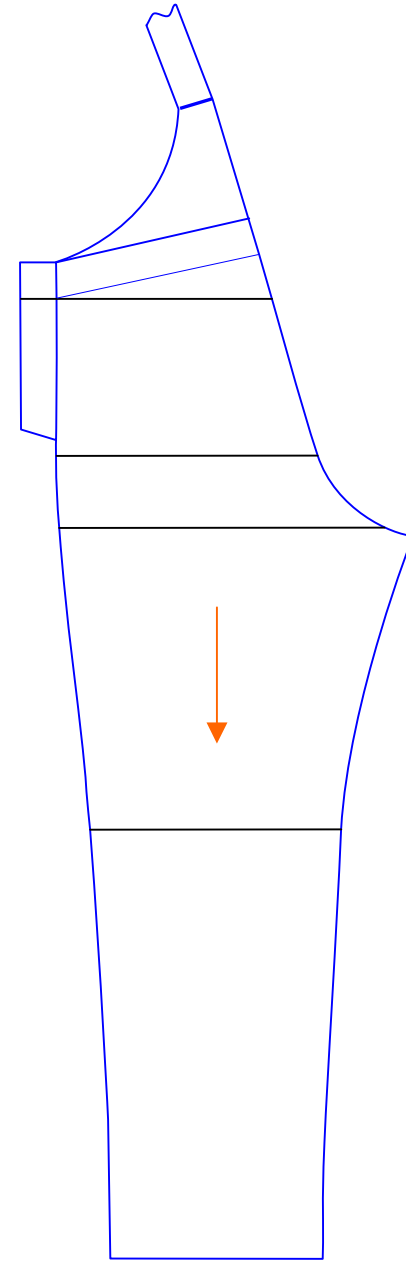

↓ Směr osnovy

Pánské pracovní kalhoty náprsní část PD

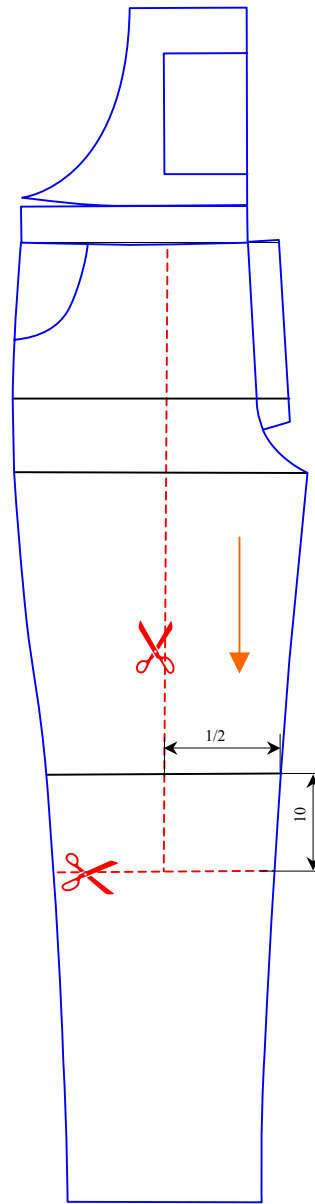
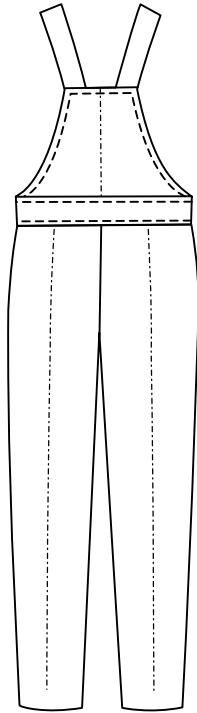
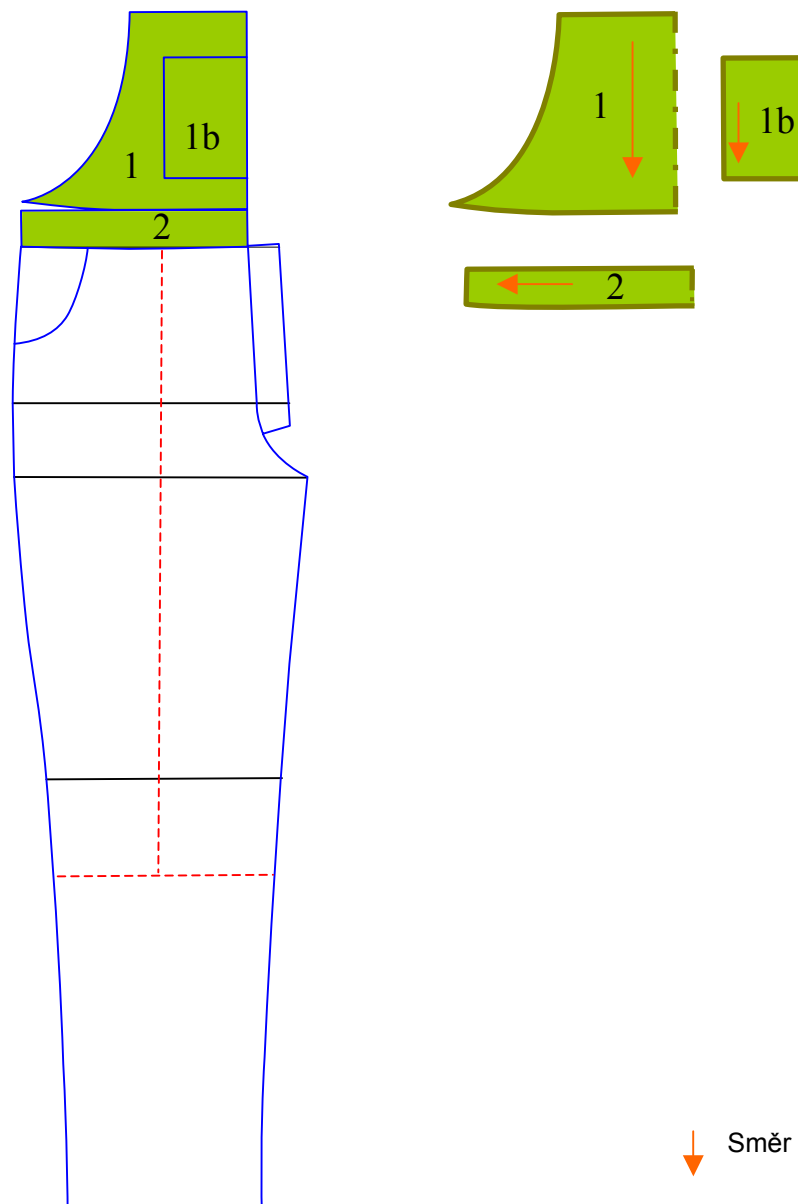

Pánské pracovní kalhoty nohavicová část PD

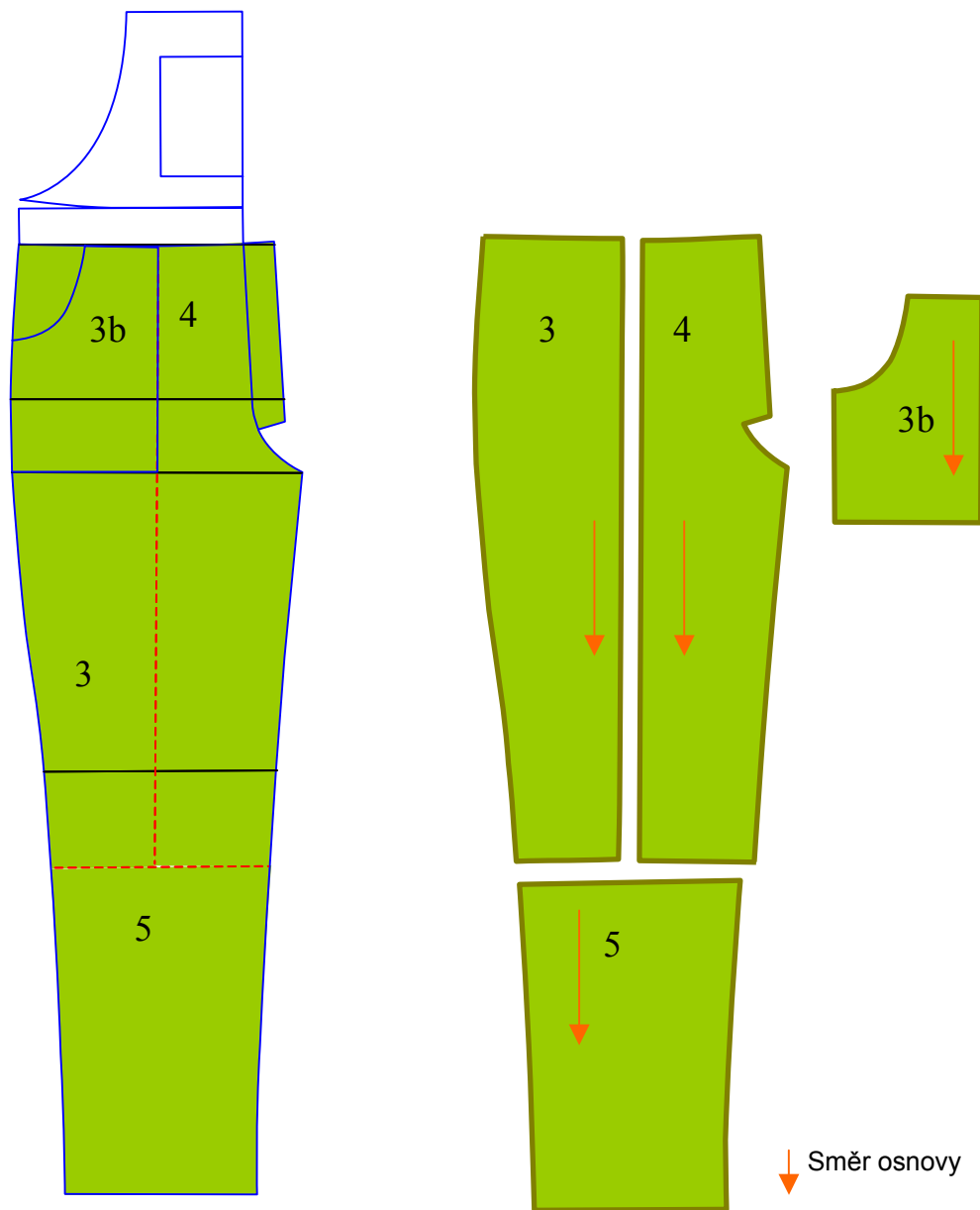
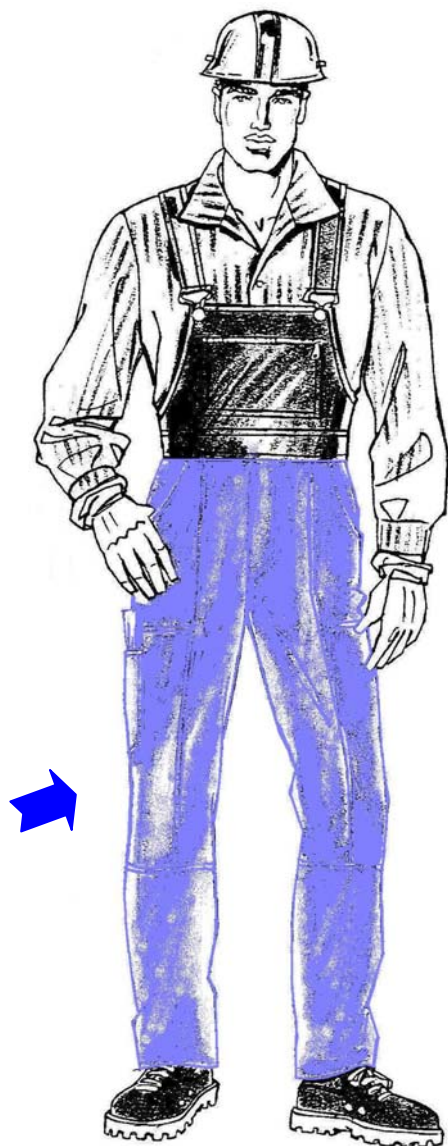

Pánské pracovní kalhoty

části zadního dílu

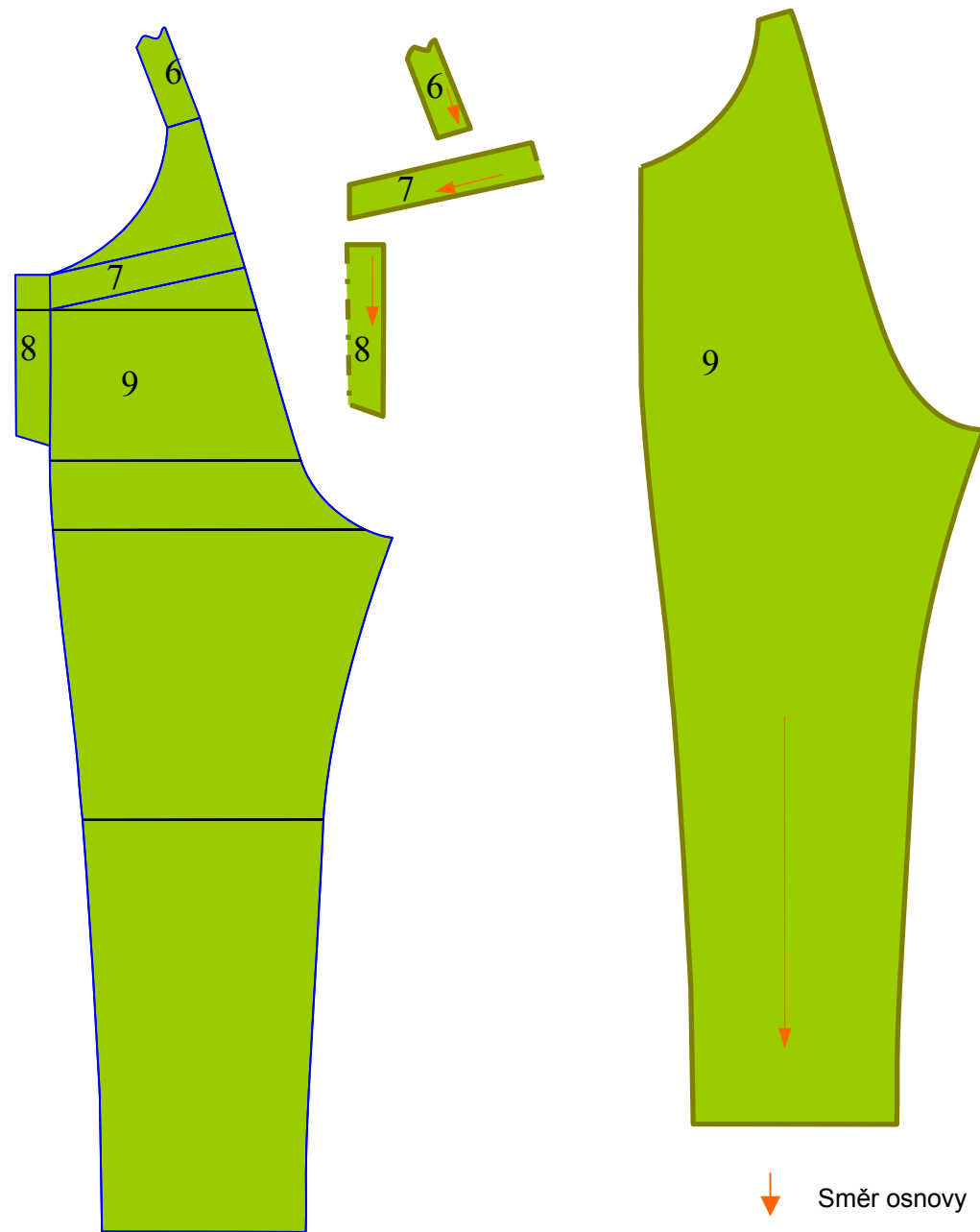
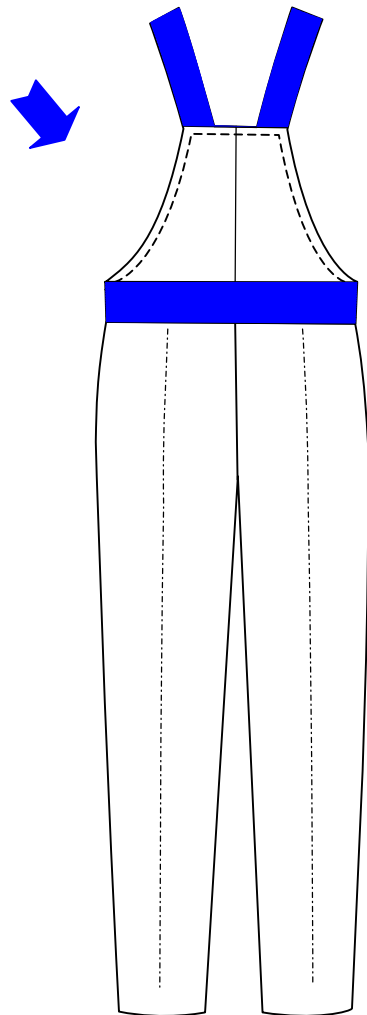

Pánské pracovní kalhoty výsledné tvary stříhových dílů a součástí

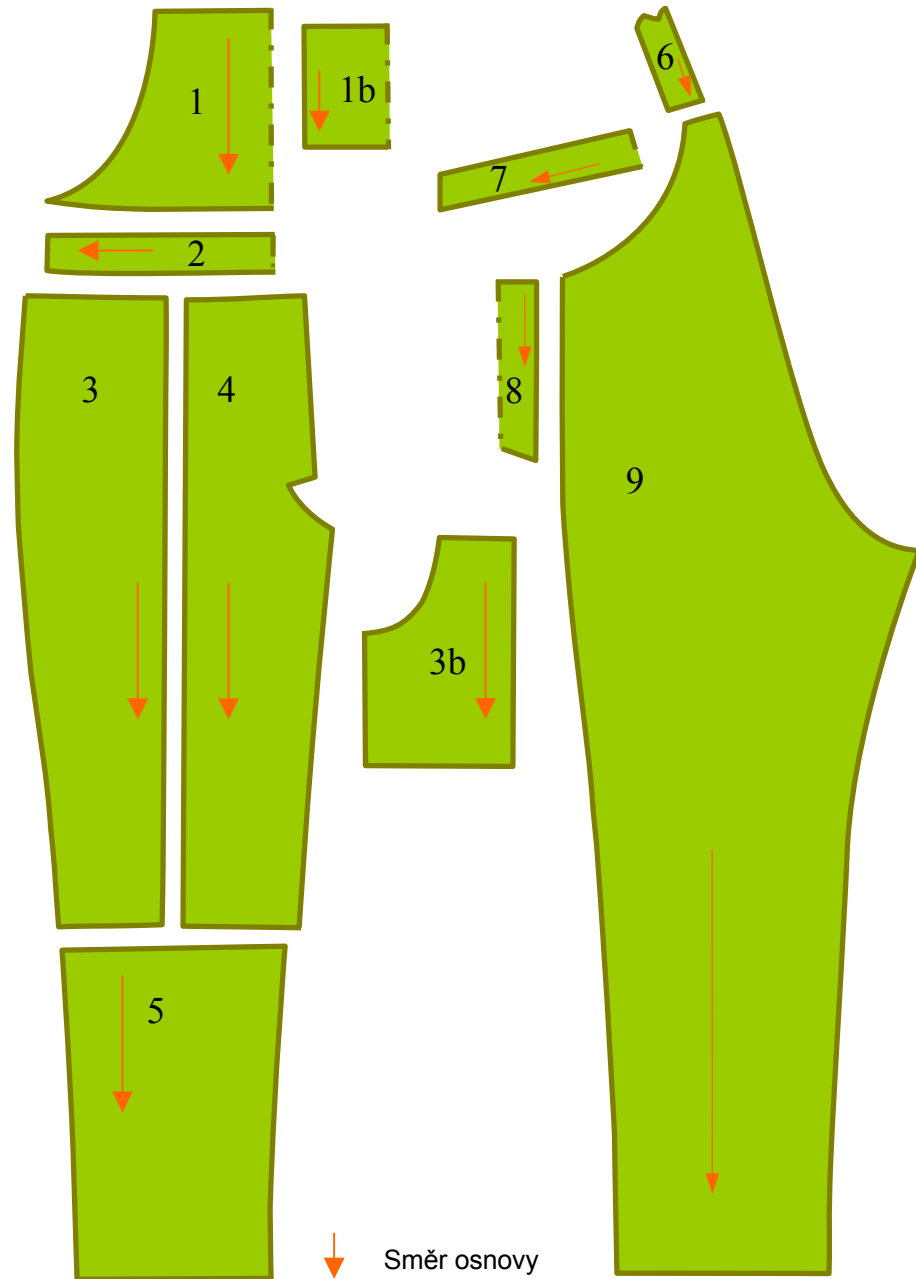
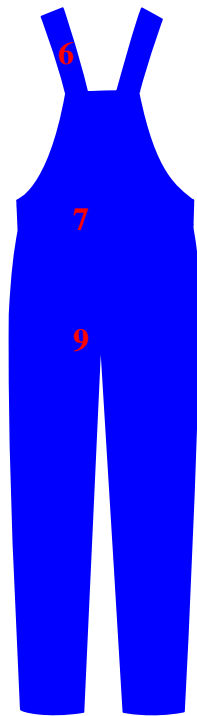
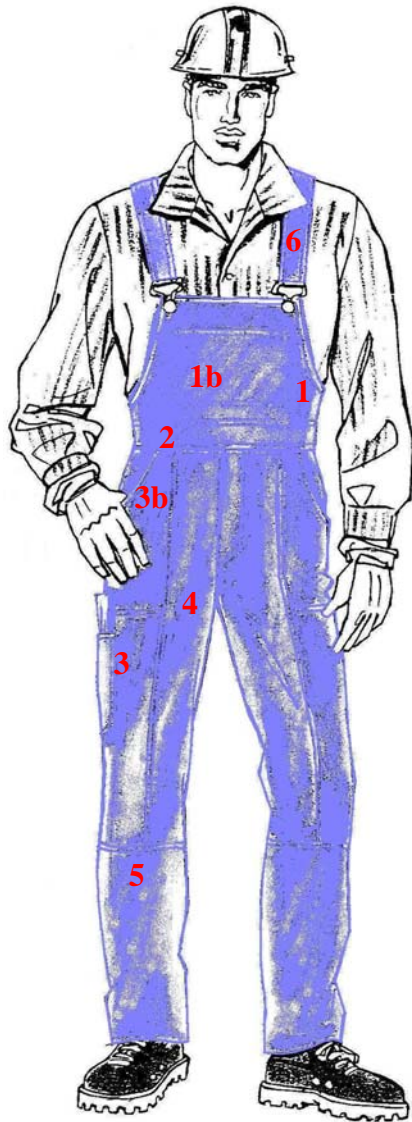

Měchová kapsa s přinechanou dvojstěnnou záhybovou plochou

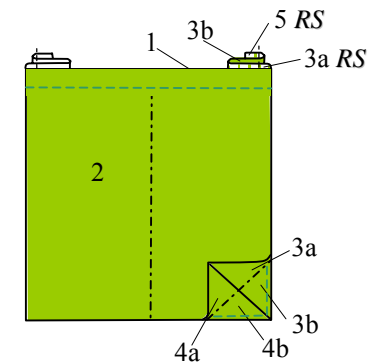
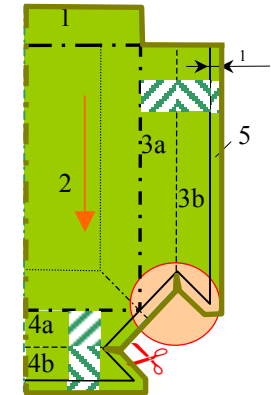
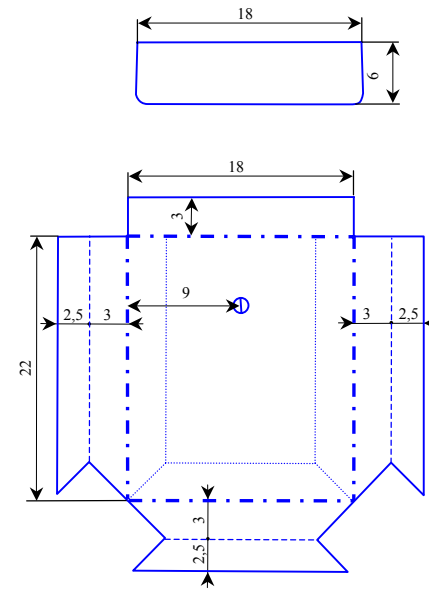
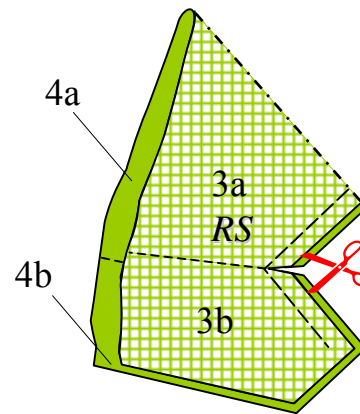
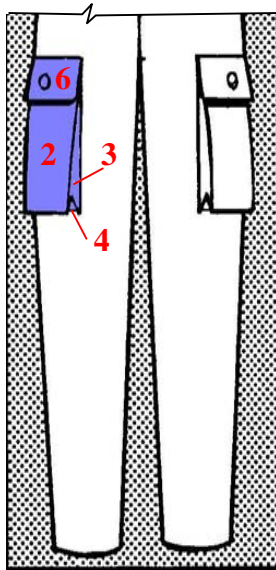
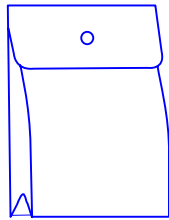

↓ Směr osnovy

Měchová kapsa oblého tvaru s dvojstěnnou záhybovou plochou

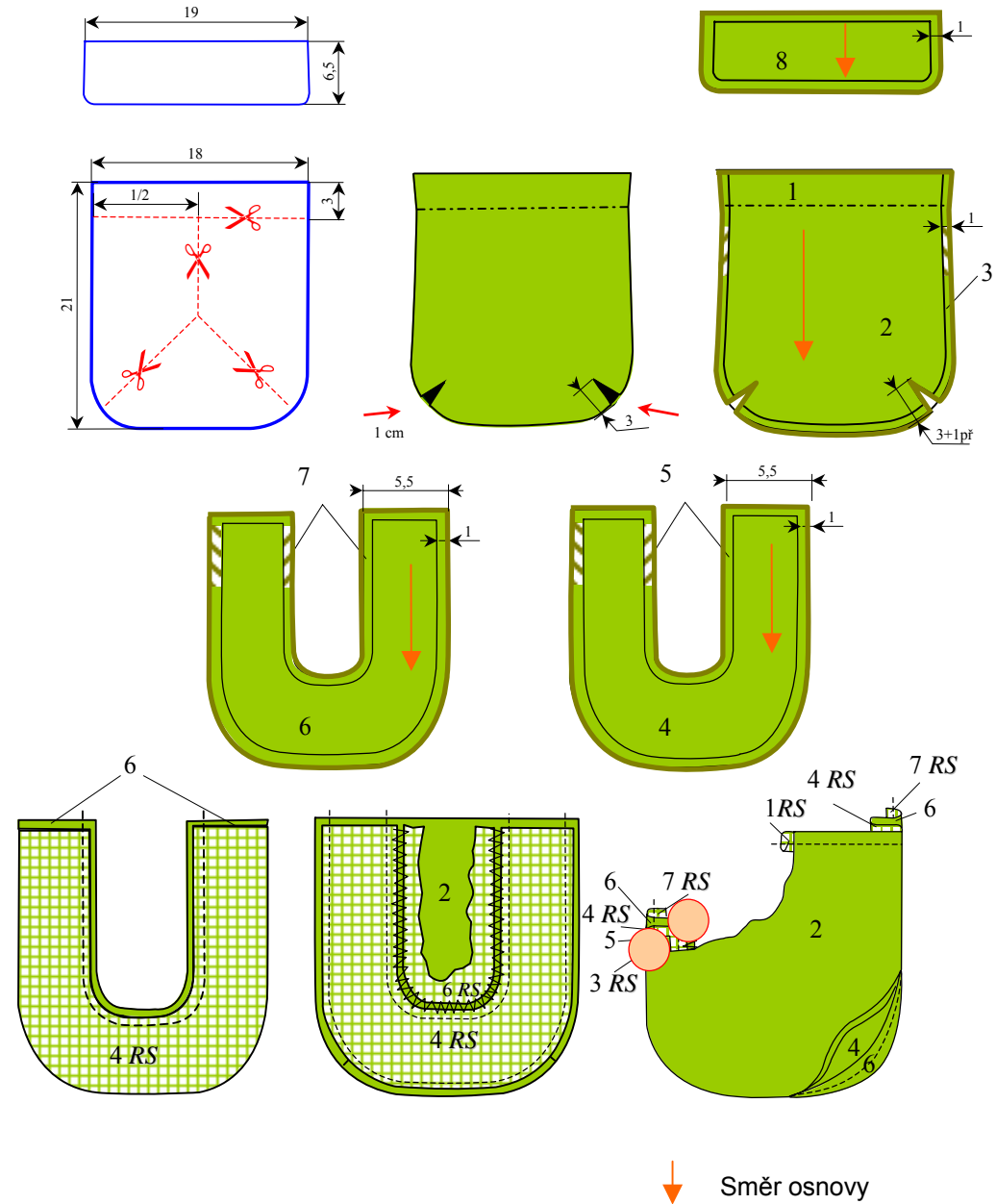
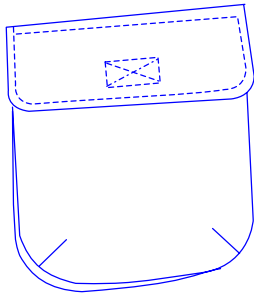

Měchová kapsa s přisazenou záhybovou plochou

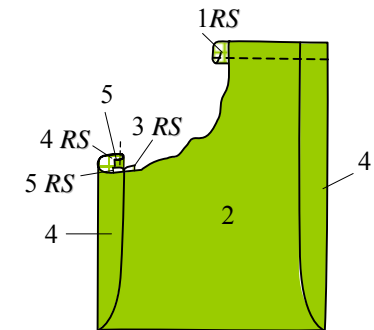
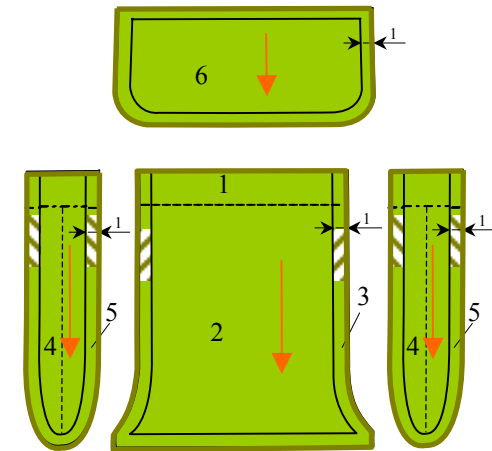
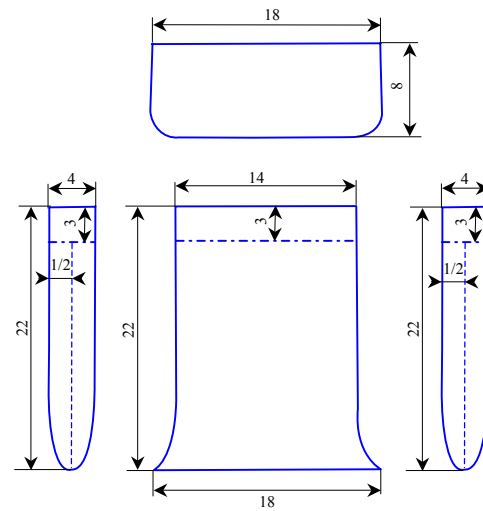
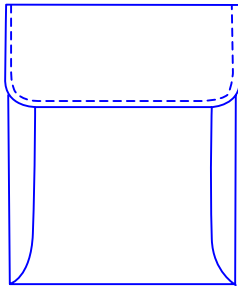

↓ Směr osnovy