

THEORY AND PROBLEMS OF POROELASTICITY

Arnold Verruijt

Delft University of Technology

2015

PREFACE

Many years ago it was suggested by Professor Robert E. Gibson to a group of colleagues to write a book on the theory of consolidation, as the theory of poroelasticity was then called, on the lines of the classical treatise by Carslaw and Jaeger on the Conduction of Heat in Solids. Some of us have written parts of such a book, notably Professors Gerard De Josselin de Jong and Robert L. Schiffman, but it appeared that the task was too large, perhaps also because some of us got other interests, and the difficulties in completing solutions required so much mathematical effort that many papers had to finish by announcing that more results would be published in later papers, which never actually occurred. In the meantime solutions of many problems were published, and now that I have retired from university duties there is some time to complete and update existing solutions, and publish the material in the form of this book. It also helped that my colleagues Professors Booker, Carter and Small, of Sydney University, drew my attention to numerical techniques for inverse Laplace transforms, especially Talbot's method, which is a simple and effective method for the solution of many problems, so that the promises made earlier for detailed solutions can now be fulfilled. On the other hand, so many solutions of problems have now been published by authors from many places in the world that this book is far from being complete, and merely gives a personal view of the main aspects of the theory, some powerful solution methods, and examples of solutions.

The theory is presented in Chapter 1, following the classical approach used in most books on soil mechanics, but with the generalization that the fluid and the particles are assumed to be compressible. The simplest problem of poroelasticity is the one-dimensional consolidation problem considered by Terzaghi. This is presented in Chapter 2, together with some generalizations, such as the case of a layered soil. Emphasis is on analytical solutions, using the Laplace transform technique. It is shown that the results agree with numerical computations using one-dimensional finite elements. In Chapter 3 some examples are given of three-dimensional problems, such as the problems considered by Mandel and Cryer, which were the first to show the unexpected behaviour of three-dimensional consolidation now known as the Mandel-Cryer effect. The theory of poroelasticity is also at the basis of many geohydrological applications, such as the flow to wells in aquifers. These are considered in Chapter 5, including a model in which horizontal displacements are taken into account. This is a particular example demonstrating the power of the three-dimensional theory of Biot. It is shown that the horizontal displacements in a pumped aquifer should not be neglected, as has often been done. Chapters 6, 7 and 8 contain several examples of problems for a half space or a layer, for which the solution method was first presented by McNamee and Gibson. It appears that the applicability of the original analytical solution method can be greatly extended when using a numerical method for the inverse Laplace transformation. Actually, for many problems a comparison is given of the analytical solution with Talbot's numerical method. Because in each case the agreement appears to be excellent it can be concluded that numerical inverse Laplace transformation is very powerful. In the last two chapters the finite element method is presented for plane strain problems and for axially symmetric problems. Several examples using the computer programs accompanying this book are given, including the solution for the flow to a well in a layered system, which shows the Noordbergum effect, a phenomenon that has intrigued the author for 50 years.

This is a version of the book in PDF format, which can be read using the ADOBE ACROBAT reader. This version has been published for some time on the author's website <<http://geo.verruijt.net>>. The website also contains some computer programs that may be useful for a further illustration of the solutions. Updates of the book and the programs will be published on this website.

The text has been prepared using the \LaTeX version (Lamport, 1994) of the program \TeX (Knuth, 1986). The $\text{P}\text{C}\text{T}\text{E}\text{X}$ macros (Wichura, 1987) have been used to prepare the figures, with color being added in this version to enhance the appearance of the figures. Modern software provides a major impetus to the production of books and papers in facilitating the illustration of complex solutions by numerical and graphical examples.

In this edition some errors have been corrected, some references and figures have been added, especially in Chapter 5, and in Chapters 9 and 10 the derivations have been updated.

Delft, 2015

Arnold Verruijt

e-mail : a.verruijt@verruijt.net
website : <http://geo.verruijt.net>

TABLE OF CONTENTS

1. Theory of Poroelasticity	1
1.1 Poroelasticity	1
1.2 Undrained compression of a porous medium	2
1.3 The principle of effective stress	3
1.4 Conservation of Mass	4
1.5 Darcy's Law	6
1.6 Equilibrium equations	7
1.7 Initial conditions and boundary conditions	9
1.8 Drained deformations	9
1.9 Undrained deformations	10
1.10 Uncoupled consolidation	12
2. One-Dimensional Problems	16
2.1 Introduction	16
2.2 Terzaghi's problem	16
2.3 Terzaghi and mixture theory	25
2.4 Periodic load	29
2.5 Two-layered soil	37
2.6 One-dimensional finite elements	44
3. Elementary problems	49
3.1 Introduction	49
3.2 Mandel's problem	49
3.3 Cryer's problem	58
3.4 De Leeuw's problem	66
3.5 Spherical source in infinite medium	74
3.6 De Josselin de Jong's problem	81
3.7 A problem of Booker and Carter	87
3.8 Approximate solutions	96
4. Seabed response to water waves	101
4.1 Introduction	101
4.2 Stationary wave	101
4.3 Traveling wave	107
4.4 Approximation of waves	108
5. Flow to wells	109
5.1 Introduction	109
5.2 A well in an infinite confined aquifer	109
5.3 Superposition and images	112
5.4 A well in a finite confined aquifer	113
5.5 A plane stress model	117
5.6 A well in a leaky aquifer, plane stress model	127
5.7 Some mathematical functions	138

6.	Plane Strain Half Space Problems	140
	6.1 Introduction	140
	6.2 Plane strain deformations	140
	6.3 Strip load on half space	143
7.	Plane Strain Layer	160
	7.1 Introduction	160
	7.2 Plane strain deformations	160
	7.3 Strip load on layer	161
	7.4 Concluding remarks	182
8.	Axially Symmetric Half Space Problems	183
	8.1 Introduction	183
	8.2 Axially symmetric deformations	183
	8.3 Disk load on half space	186
9.	Plane Strain Finite Elements	208
	9.1 Introduction	208
	9.2 Plane strain poroelasticity	208
	9.3 Computer program	224
10.	Axially Symmetric Finite Elements	230
	10.1 Introduction	230
	10.2 Axially symmetric poroelasticity	230
	10.3 Computer program	246
A.	Laplace transforms	254
	References	256
	Author Index	262
	Subject Index	265

Chapter 1

THEORY OF POROELASTICITY

1.1 Poroelasticity

Soft soils such as sand and clay consist of small particles, and often the pore space between the particles is filled with water. In soil mechanics this is denoted as a saturated or partially saturated *porous medium*. The deformation of such porous media depends upon the stiffness of the porous material, and upon the behaviour of the fluid in the pores. If the permeability of the material is small, the deformations may be considerably retarded by the viscous behaviour of the fluid in the pores. The simultaneous deformation of the porous material and the flow of the pore fluid is the subject of the theory of consolidation, often denoted as *poroelasticity*.

The theory was developed originally by Terzaghi (1923, 1925) for the one-dimensional case, and extended to three dimensions by Biot (1941), and it has been studied extensively since. In his original theory Terzaghi postulated that the deformations of a soil were mainly caused by a rearrangement of the system of the particles, and that the compression of the pore fluid and of the solid particles can practically be disregarded. In a saturated soil this means that a volume change of an element of soil can only occur by a net flow of the fluid with respect to the solid particles. This system of assumptions often is a good approximation of the real behaviour of soft soils, especially clay, and also soft sands. Such soils are highly compressible (deformations may be as large as several percents), whereas the constituents, particles and fluid, are very stiff.

In later presentations of the theory, starting with those of Biot, compression of the pore fluid and compression of the particles has been taken into account. This generalization has made it possible to also consider the deformations of stiffer materials such as sandstone and other porous rocks, which are very important in the engineering of deep reservoirs of oil or gas. The linear theory of poroelasticity (or consolidation) has now reached a stage where there is practically general consensus on the basic equations, see e.g. Detournay & Cheng (1993), De Boer (2000), Wang (2000), Rudnicki (2001), Coussy (2004), Gambolati (2006), Verruijt (2008). It may be noted that important contributions were published independently in Russian publications, especially by Gersevanov (1934), Florin (1961) and Zaretsky (1967), see also Tsyтович & Zaretsky (1969).

Unfortunately, there is no general agreement on the definitions and the notations of the basic physical parameters in the theory of poroelasticity or consolidation. In this book the variables and the notations are taken in agreement with the presentations of soil mechanics, as in the books by Terzaghi (1943), Lambe & Whitman (1969), Craig (1997) and others. This means that compressive stresses are considered as positive. It may be noted that Biot (1941) used quite different notations, especially for the coupling variables, and in his later publications, for instance Biot & Willis (1957), he modified these again. The notations in the presentation of the basic equations in this book are mainly based on the works of Gassmann (1951), Geertsma (1957), Skempton (1960) and Bishop (1973). The term poroelasticity for the mechanics of a porous elastic material was introduced by Geertsma (1957), noting the analogy of the basic equations with the theory of thermoelasticity. He also expressed the parameters of the theory into basic physical parameters, such as the compressibilities of the fluid and the solid particles.

In this chapter the basic equations of the general theory of linear poroelasticity are derived, for the case of a linear material, considering static deformations only, i.e. disregarding inertial forces. Some simplified versions of the theory are also presented in this chapter. The analytical solutions for two simple examples are given. In later chapters many solutions and solution methods will be presented.

The basic principles of the theory of poroelasticity are twofold: the equations of equilibrium of the porous medium, and the equations of conservation of mass of the two components: the solids and the pore fluid. It is convenient to start by considering the influence of the compressibilities of the two constituents on the behaviour of a porous medium in the absence of drainage.

1.2 Undrained compression of a porous medium

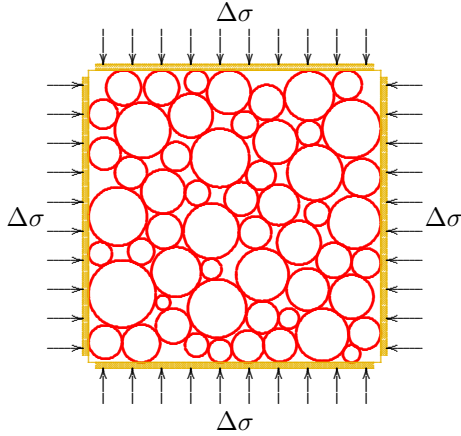

Figure 1.1: Soil Element.

In the first stage, in which the stress in both fluid and particles is increased by Δp , the volume change of the pore fluid is

$$\Delta V_f = -nC_f \Delta p V, \quad (1.1)$$

where C_f is the compressibility of the pore fluid (which may include the compression of small amounts of isolated gas bubbles in the fluid), and V is the total volume of the element considered, so that the original volume of the pores is nV . The volume change of the particles is, because the original volume of the particles is $(1-n)V$,

$$\Delta V_s = -(1-n)C_s \Delta p V, \quad (1.2)$$

where C_s is the compressibility of the solid material. Assuming that the solid particles all have the same compressibility, it follows that their uniform compression leads to a volume change of the pore space as well (at this stage compatibility of the deformations of fluid and particles is ignored) of the same magnitude. Thus the total volume change of the porous medium is

$$\Delta V = -C_s \Delta p V. \quad (1.3)$$

In the second stage the pressure in the fluid remains unchanged, so that there is no volume change of the fluid,

$$\Delta V_f = 0. \quad (1.4)$$

The stress increment $\Delta\sigma - \Delta p$ on the soil, at constant pore pressure, leads to an average stress increment in the solid particles of magnitude $(\Delta\sigma - \Delta p)/(1-n)$. The resulting volume change of the particles is

$$\Delta V_s = -C_s (\Delta\sigma - \Delta p) V. \quad (1.5)$$

The volume change of the porous medium as a whole in this stage also involves the deformations due to sliding and rolling at the contacts of the particles. Assuming that this is also a linear process, in a first approximation, it follows that in this stage of loading

$$\Delta V = -C_m (\Delta\sigma - \Delta p) V, \quad (1.6)$$

where C_m is the compressibility of the porous medium. It is to be expected that this is considerably larger than the compressibilities of the two constituents: fluid and solid particles, because the main mechanism of soil deformation is not so much the compression of the fluid or the particles, but rather the deformation due to a rearrangement of the particles, including sliding and rolling of particles over each other.

Let there be considered an element of porous soil or rock, of porosity n , saturated with a fluid, see Figure 1.1, where the porosity is defined as the volume of the pores per unit total volume of the soil. The element is loaded by an isotropic total stress $\Delta\sigma$, in undrained condition, i.e. with no fluid flowing into or out of the element. The resulting pore pressure (the pressure in the pore fluid) is denoted by Δp . In order to determine the relation between Δp and $\Delta\sigma$ the load is considered to be applied in two stages : a first stage with an increment of pressure both in the fluid and in the soil particles of magnitude Δp , and a second stage with a load on the soil particles only, of magnitude $\Delta\sigma - \Delta p$. Compatibility of the two stages, requiring that the total volume change is the sum of the volume changes of the fluid and the solid particles, will be required only for the combination of the two stages.

Due to both these two loadings the volume changes are, for the fluid:

$$\Delta V_f = -nC_f \Delta p V, \quad (1.7)$$

for the solid particles:

$$\Delta V_s = -(1-n)C_s \Delta p V - C_s(\Delta\sigma - \Delta p)V, \quad (1.8)$$

and for the porous medium as a whole:

$$\Delta V = -C_s \Delta p V - C_m(\Delta\sigma - \Delta p)V. \quad (1.9)$$

Because there is no drainage in the combined loading situation, by assumption, the total volume change must be equal to the sum of the volume changes of the fluid and the particles, $\Delta V = \Delta V_f + \Delta V_s$. This gives, with equations (1.7) – (1.9),

$$\frac{\Delta p}{\Delta\sigma} = B = \frac{1}{1 + n(C_f - C_s)/(C_m - C_s)} = \frac{C_m - C_s}{(C_m - C_s) + n(C_f - C_s)}. \quad (1.10)$$

The derivation leading to this equation is due to Bishop (1973), but similar equations were given earlier by Gassmann (1951) and Geertsma (1957), see also Berryman (1999). The ratio $\Delta p/\Delta\sigma$ under isotropic loading is often denoted by B in soil mechanics (Skempton, 1954). In early developments, such as in Terzaghi's publications, the compressibilities of the fluid and of the solid particles were disregarded, $C_f = C_s = 0$. In that case $B = 1$, which is sometimes used as a first approximation in soil mechanics.

The coefficient B , and a similar coefficient A relating the excess pore pressure to an increment of deviatoric stress, can easily be determined experimentally by performing an undrained triaxial test (Bishop & Henkel, 1962).

1.3 The principle of effective stress

The effective stress, introduced by Terzaghi (1923, 1925), is defined as that part of the total stresses that governs the deformation of the soil or rock. It is assumed that the total stresses can be decomposed into the sum of the effective stresses and the pore pressure by writing

$$\sigma_{ij} = \sigma'_{ij} + \alpha p \delta_{ij}, \quad (1.11)$$

where σ_{ij} are the components of total stress, σ'_{ij} are the components of effective stress, p is the pore pressure (the pressure in the fluid in the pores), δ_{ij} are the Kronecker delta symbols ($\delta_{ij} = 1$ if $i = j$ and $\delta_{ij} = 0$ otherwise), and α is Biot's coefficient, which is unknown at this stage. For the isotropic parts of the stresses it follows from equation (1.11) that

$$\sigma = \sigma' + \alpha p. \quad (1.12)$$

In the case of an isotropic linear elastic porous material the relation between the volumetric strain ε and the isotropic effective stress is of the form

$$\varepsilon = \frac{\Delta V}{V} = -C_m \Delta\sigma' = -C_m \Delta\sigma + C_m \alpha \Delta p, \quad (1.13)$$

where, as before, C_m denotes the compressibility of the porous material, the inverse of its compression modulus, $C_m = 1/K$. Equation (1.13) should be in agreement with equation (1.9), which is the case only if

$$\alpha = 1 - C_s/C_m. \quad (1.14)$$

This expression for Biot's coefficient is generally accepted in rock mechanics (Biot & Willis, 1957), (Geertsma, 1957), and in the mechanics of other porous materials, such as bone or skin (Coussy, 2004). For soft soils the value of α is close to 1.

If the coefficient α is taken as 1, the effective stress principle reduces to

$$\alpha = 1 : \sigma_{ij} = \sigma'_{ij} + p \delta_{ij}, \quad (1.15)$$

This is the form in which the effective stress principle is often expressed in soil mechanics, on the basis of Terzaghi's original work (1923, 1925, 1943). This is often justified because soil mechanics practice usually deals with highly compressible clays or sands, in which the compressibility of the solid particles is very small compared to the compressibility of the porous material as a whole. In this case the effective stress is also the average of the forces transmitted in the isolated contact points between the particles. This is sometimes denoted as the *intergranular stress*.

The notion of the effective stress, with its definition by equation (1.11) or (1.15), is perhaps the most important contribution off Terzaghi to soil mechanics. It should especially be noted that the effective stress should not be confused with the average stress in the particles, which would be obtained by subtracting the average pore pressure np from the total stress σ . It is essential that it is recognized that the pore pressure p not only acts in the pores, but also in the particles, which are fully surrounded by pore fluid.

1.4 Conservation of mass

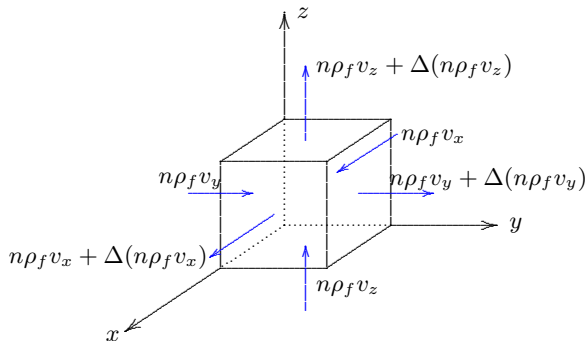

Figure 1.2: Conservation of mass of the fluid.

and the fluid can be established by considering the flow into and out of an elementary volume, fixed in space, see figure 1.2.

The mass of the fluid in an elementary volume V is $n\rho_f V$. The increment of this mass per unit time is determined by the net inward flux across the surfaces of the element. In y -direction the flow through the left and the right faces of the element shown in figure 1.2 (both having an area $\Delta x \Delta z$), leads to a net outward flux of magnitude

$$\Delta(n\rho_f v_y) \Delta x \Delta z = \frac{\Delta(n\rho_f v_y)}{\Delta y} V,$$

where V denotes the volume of the element, $V = \Delta x \Delta y \Delta z$. This leads to the following mass balance equation

$$\frac{\partial(n\rho_f)}{\partial t} + \frac{\partial(n\rho_f v_x)}{\partial x} + \frac{\partial(n\rho_f v_y)}{\partial y} + \frac{\partial(n\rho_f v_z)}{\partial z} = 0. \quad (1.16)$$

Using vector notation this can also be written as

$$\frac{\partial(n\rho_f)}{\partial t} + \nabla \cdot (n\rho_f \mathbf{v}) = 0. \quad (1.17)$$

The compressibility of the fluid can be expressed by assuming that the constitutive equation of the fluid is

$$\frac{d\rho_f}{dp} = \rho_f C_f, \quad (1.18)$$

which is in agreement with the definition of the fluid compressibility C_f in equation (1.7). For pure water the compressibility is $C_f \approx 0.5 \times 10^{-9} \text{ m}^2/\text{kN}$. For a fluid containing small amounts of a gas the compressibility may be considerably larger, however. It now follows from equation (1.17) that

$$\frac{\partial n}{\partial t} + n C_f \frac{\partial p}{\partial t} + \nabla \cdot (n \mathbf{v}) = 0, \quad (1.19)$$

where a term expressing the product of the fluid velocity and the pressure gradient has been disregarded, assuming that both are small quantities, so that the product is of second order.

One of the major principles of the theory of consolidation is that the mass of the two components, water and solid particles, must be conserved. This will be formulated in this section.

Consider a porous material, consisting of a solid matrix or an assembly of particles, with a continuous pore space. The pore space is filled with a fluid, usually water, but possibly some other fluid, or a mixture of fluids. The average velocity of the fluid is denoted by \mathbf{v} and the average velocity of the solids is denoted by \mathbf{w} . The densities are denoted by ρ_f and ρ_s , respectively, and the porosity by n .

The equations of conservation of mass of the solids

The balance equation for the solid material is

$$\frac{\partial[(1-n)\rho_s]}{\partial t} + \nabla \cdot [(1-n)\rho_s \mathbf{w}] = 0. \quad (1.20)$$

It is now assumed that the density of the solid particles is a function of the isotropic total stress σ and the fluid pressure p , so that

$$\frac{\partial \rho_s}{\partial t} = \frac{\rho_s C_s}{1-n} \left(\frac{\partial \sigma}{\partial t} - n \frac{\partial p}{\partial t} \right), \quad (1.21)$$

which is in agreement with equation (1.8). The parameter C_s is the compressibility of the solid particles. Equation (1.20) now reduces to

$$-\frac{\partial n}{\partial t} + C_s \left(\frac{\partial \sigma}{\partial t} - n \frac{\partial p}{\partial t} \right) + \nabla \cdot [(1-n)\mathbf{w}] = 0, \quad (1.22)$$

where again a term expressing the product of a velocity and a gradient of stress or pressure has been disregarded.

The time derivative of the porosity n can easily be eliminated from eqs. (1.22) and (1.19) by adding these two equations. This gives

$$\nabla \cdot \mathbf{w} + \nabla \cdot [n(\mathbf{v} - \mathbf{w})] + n(C_f - C_s) \frac{\partial p}{\partial t} + C_s \frac{\partial \sigma}{\partial t} = 0. \quad (1.23)$$

The quantity $n(\mathbf{v} - \mathbf{w})$ is the porosity multiplied by the relative velocity of the fluid with respect to the solids. This is precisely what is intended by the *specific discharge*, which is the quantity that appears in Darcy's law for the flow of a fluid through a porous medium. It will be denoted by \mathbf{q} ,

$$\mathbf{q} = n(\mathbf{v} - \mathbf{w}). \quad (1.24)$$

It seems almost trivial that it is this relative velocity that should be used in expressions for Darcy's law, but the first to state this explicitly was Gersevanov (1934).

If the displacement vector of the solids is denoted by \mathbf{u} , the term $\nabla \cdot \mathbf{w}$ can also be written as $\partial \varepsilon / \partial t$, where ε is the volume strain,

$$\varepsilon = \nabla \cdot \mathbf{u}. \quad (1.25)$$

Equation (1.23) can now be written as

$$\frac{\partial \varepsilon}{\partial t} + n(C_f - C_s) \frac{\partial p}{\partial t} + C_s \frac{\partial \sigma}{\partial t} = -\nabla \cdot \mathbf{q}. \quad (1.26)$$

Because the isotropic total stress can be expressed as $\sigma = \sigma' + \alpha p$, see equation (1.12), and the isotropic effective stress can be related to the volume strain by $\sigma' = -\varepsilon / C_m$, where C_m is the compressibility of the porous medium, see equation (1.13), it follows that equation (1.26) can also be written as

$$\alpha \frac{\partial \varepsilon}{\partial t} + S \frac{\partial p}{\partial t} = -\nabla \cdot \mathbf{q}, \quad (1.27)$$

where, as before, $\alpha = 1 - C_s / C_m$, and S is the *storativity*,

$$S = nC_f + (\alpha - n)C_s. \quad (1.28)$$

Equation (1.27) will be denoted as the *storage equation*. It is an important basic equation of the theory of consolidation. In its form (1.27) it admits a simple heuristic interpretation: the compression of the soil consists of the compression of the pore fluid and the particles plus the amount of fluid expelled from an element by flow. As the derivation shows, the equation actually expresses conservation of mass of fluids and solids, together with some notions about the compressibilities.

It may be noted that in deriving equation (1.27) a number of assumptions have been made, so that the equation is not completely exact, but all assumptions are very realistic. Thus, it has been assumed that the solid particles and the fluid are linearly compressible, and some second order terms, consisting of the products

of small quantities, have been disregarded. The storage equation (1.27) can therefore be considered as an accurate approximation of physical reality.

In the original presentations of Biot, and in many later publications, see for instance Detournay & Cheng (1993) and Wang (2000), equation (1.27) is often written as

$$\frac{\partial \zeta}{\partial t} = -\nabla \cdot \mathbf{q}, \quad (1.29)$$

where $\partial \zeta / \partial t$ is the change in fluid content, which is created (or defined) by the net outflow of fluid as given by the quantity $\nabla \cdot \mathbf{q}$. The relation $\partial \zeta / \partial t = \alpha \partial \varepsilon / \partial t + S \partial p / \partial t$, which generates equation (1.27), then is established on the basis of the conservation equations. In the present chapter the variable ζ will not be used, to avoid confusion with the water content used in soil mechanics literature, and which is defined differently.

1.5 Darcy's law

In 1857 Darcy found, from experiments, that the specific discharge of a fluid in a porous material is proportional to the head loss. In terms of the quantities used in this chapter, Darcy's law can be written as

$$\mathbf{q} = -\frac{\kappa}{\mu}(\nabla p - \rho_f \mathbf{g}), \quad (1.30)$$

where κ is the (intrinsic) permeability of the porous material, μ is the viscosity of the fluid, and \mathbf{g} is the gravity vector. The permeability depends upon the size of the pores. As a first approximation one may consider that the permeability κ is proportional to the square of the particle size.

If the coordinate system is such that the z -axis is pointing in upward vertical direction the components of the gravity vector are $g_x = 0$, $g_y = 0$, $g_z = -g$, and then Darcy's law may also be written as

$$q_x = -\frac{\kappa}{\mu} \frac{\partial p}{\partial x}, \quad q_y = -\frac{\kappa}{\mu} \frac{\partial p}{\partial y}, \quad q_z = -\frac{\kappa}{\mu} \left(\frac{\partial p}{\partial z} + \rho_f g \right). \quad (1.31)$$

The product $\rho_f g$ may also be written as γ_w , the volumetric weight of the fluid.

In soil mechanics practice the coefficient in Darcy's law is often expressed in terms of the hydraulic conductivity k rather than the permeability κ . This hydraulic conductivity (sometimes denoted as the coefficient of permeability) is defined as

$$k = \frac{\kappa \rho_f g}{\mu}. \quad (1.32)$$

This means that Darcy's law can also be written as

$$q_x = -\frac{k}{\gamma_w} \frac{\partial p}{\partial x}, \quad q_y = -\frac{k}{\gamma_w} \frac{\partial p}{\partial y}, \quad q_z = -\frac{k}{\gamma_w} \left(\frac{\partial p}{\partial z} + \gamma_w \right). \quad (1.33)$$

From these equations it follows that

$$\nabla \cdot \mathbf{q} = \frac{\partial q_x}{\partial x} + \frac{\partial q_y}{\partial y} + \frac{\partial q_z}{\partial z} = -\nabla \cdot \left(\frac{k}{\gamma_w} \nabla p \right), \quad (1.34)$$

if again a small second order term is disregarded.

Substitution of (1.34) into (1.27) gives

$$\alpha \frac{\partial \varepsilon}{\partial t} + S \frac{\partial p}{\partial t} = \nabla \cdot \left(\frac{k}{\gamma_w} \nabla p \right). \quad (1.35)$$

Compared to equation (1.27) the only additional assumption is the validity of Darcy's law. As Darcy's law usually gives a good description of flow in a porous medium, equation (1.35) can be considered as reasonably accurate.

In the case of a homogeneous material the hydraulic conductivity k and the volumetric weight of the fluid γ_w can be considered as constants. Equation (1.35) then reduces to

$$\alpha \frac{\partial \varepsilon}{\partial t} + S \frac{\partial p}{\partial t} = \frac{k}{\gamma_w} \nabla^2 p. \quad (1.36)$$

where the operator ∇^2 is defined as

$$\nabla^2 = \frac{\partial^2}{\partial x^2} + \frac{\partial^2}{\partial y^2} + \frac{\partial^2}{\partial z^2}. \quad (1.37)$$

1.6 Equilibrium equations

The complete formulation of a fully three-dimensional problem requires a consideration of the principles of solid mechanics, including equilibrium, compatibility and the stress-strain-relations. In addition to these equations the initial conditions and the boundary conditions must be formulated. These equations are presented here, for a linear elastic material.

The equations of equilibrium can be established by considering the stresses acting upon the six faces of an elementary volume, see figure 1.3. In this figure only the six stress components in the y -direction are shown. The equilibrium equations in the three coordinate directions are

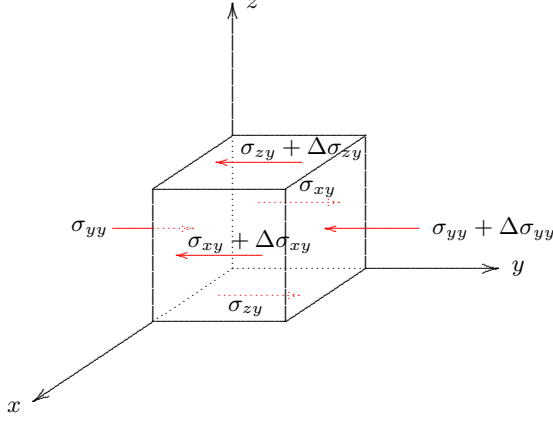

Figure 1.3: Equilibrium of element.

$$\begin{aligned} \frac{\partial \sigma_{xx}}{\partial x} + \frac{\partial \sigma_{yx}}{\partial y} + \frac{\partial \sigma_{zx}}{\partial z} - f_x &= 0, \\ \frac{\partial \sigma_{xy}}{\partial x} + \frac{\partial \sigma_{yy}}{\partial y} + \frac{\partial \sigma_{zy}}{\partial z} - f_y &= 0, \\ \frac{\partial \sigma_{xz}}{\partial x} + \frac{\partial \sigma_{yz}}{\partial y} + \frac{\partial \sigma_{zz}}{\partial z} - f_z &= 0, \end{aligned} \quad (1.38)$$

where f_x , f_y and f_z denote the components of a possible body force. In addition to these equilibrium conditions there are three equations of equilibrium of moments.

These can be taken into account most conveniently by noting that they result in the symmetry of the stress tensor,

$$\begin{aligned} \sigma_{xy} &= \sigma_{yx}, \\ \sigma_{yz} &= \sigma_{zy}, \\ \sigma_{zx} &= \sigma_{xz}. \end{aligned} \quad (1.39)$$

The stresses in the equations (1.38) and (1.39) are total stresses. The normal stresses are considered positive for compression, in agreement with common soil mechanics practice, but in contrast with the usual sign convention in solid mechanics.

The total stresses are related to the effective stresses by the generalized Terzaghi principle, see equation (1.11),

$$\begin{aligned} \sigma_{xx} &= \sigma'_{xx} + \alpha p, & \sigma_{xy} &= \sigma'_{xy}, & \sigma_{xz} &= \sigma'_{xz}, \\ \sigma_{yy} &= \sigma'_{yy} + \alpha p, & \sigma_{yz} &= \sigma'_{yz}, & \sigma_{yx} &= \sigma'_{yx}, \\ \sigma_{zz} &= \sigma'_{zz} + \alpha p, & \sigma_{zx} &= \sigma'_{zx}, & \sigma_{zy} &= \sigma'_{zy}, \end{aligned} \quad (1.40)$$

where α is Biot's coefficient, $\alpha = 1 - C_s/C_m$. It should be noted that the shear stresses can only be transmitted by the soil skeleton. This may seem to violate the assumptions underlying Darcy's law, which express that viscous (shear) stresses are transmitted between the solid particles and the fluid. These shear stresses can be shown to be very small compared to the normal stress levels in soil (see e.g. Polubarinova-Kochina, 1962), and this justifies that the shear stresses between the fluid and the solid particles are disregarded in the equations of equilibrium of the soil as a whole.

The effective stresses determine the deformations of the soil. As a first approximation the effective stresses are now supposed to be related to the strains by the generalized form of Hooke's law. For an isotropic material these relations are (Sokolnikoff, 1956; Sadd, 2005)

$$\begin{aligned} \sigma'_{xx} &= -(K - \frac{2}{3}G)\varepsilon - 2G\varepsilon_{xx}, & \sigma'_{xy} &= -2G\varepsilon_{xy}, & \sigma'_{xz} &= -2G\varepsilon_{xz}, \\ \sigma'_{yy} &= -(K - \frac{2}{3}G)\varepsilon - 2G\varepsilon_{yy}, & \sigma'_{yz} &= -2G\varepsilon_{yz}, & \sigma'_{yx} &= -2G\varepsilon_{yx}, \\ \sigma'_{zz} &= -(K - \frac{2}{3}G)\varepsilon - 2G\varepsilon_{zz}, & \sigma'_{zx} &= -2G\varepsilon_{zx}, & \sigma'_{zy} &= -2G\varepsilon_{zy}, \end{aligned} \quad (1.41)$$

where K and G are the elastic coefficients of the material, the compression modulus and the shear modulus, respectively, and the components of the strain tensor are denoted by ε_{xx} , etc. The volume strain ε is $\varepsilon =$

$\varepsilon_{xx} + \varepsilon_{yy} + \varepsilon_{zz}$. In continuum mechanics the elastic coefficients are often denoted as λ and μ , the so-called Lamé constants. The relations with K and G are

$$\lambda = K - \frac{2}{3}G, \quad G = \mu. \quad (1.42)$$

The compression modulus (or bulk modulus) K is the inverse of the compressibility C_m of the porous medium $K = 1/C_m$. In soil mechanics the compression modulus K and shear modulus G are often used preferably as the two basic elastic coefficients because they so well describe the two different modes of deformation: compression and shear. It may be noted that the minus signs in equations (1.41) are a consequence of the different sign conventions for the stresses (positive for compression) and the strains (positive for extension).

It may also be mentioned here that the assumption of linear elastic behaviour of the porous medium is the weakest part of the theory. The approximations introduced previously in the behaviour of the fluid and the particles usually are very accurate compared to the approximations made by assuming linear elastic soil behaviour. Real soils often exhibit non-linear behaviour, for instance by a difference in stiffness in loading and unloading, and plastic deformations if the stresses exceed a certain level. Furthermore the behaviour of soils often depends upon the initial density (or porosity). In a soil with a small porosity the particles are so densely packed that any deformation may be accompanied by a volume increase (dilatancy). On the other hand, in a soil with a large porosity the particles may form the structure resembling a card house, so that a small deformation may lead to a contraction, sometimes with catastrophic results. All these properties are studied in modern soil mechanics, but will largely be ignored in this book. The reader may be referred to books on Theoretical Soil Mechanics, e.g. Schofield & Wroth (1968) or Wood (1990).

The volume strain ε in equations (1.41) is the sum of the three linear strains,

$$\varepsilon = \varepsilon_{xx} + \varepsilon_{yy} + \varepsilon_{zz}. \quad (1.43)$$

The strain components are related to the displacement components by the compatibility equations

$$\begin{aligned} \varepsilon_{xx} &= \frac{\partial u_x}{\partial x}, & \varepsilon_{xy} &= \frac{1}{2} \left(\frac{\partial u_x}{\partial y} + \frac{\partial u_y}{\partial x} \right), & \varepsilon_{xz} &= \frac{1}{2} \left(\frac{\partial u_x}{\partial z} + \frac{\partial u_z}{\partial x} \right), \\ \varepsilon_{yy} &= \frac{\partial u_y}{\partial y}, & \varepsilon_{yz} &= \frac{1}{2} \left(\frac{\partial u_y}{\partial z} + \frac{\partial u_z}{\partial y} \right), & \varepsilon_{yx} &= \frac{1}{2} \left(\frac{\partial u_y}{\partial x} + \frac{\partial u_x}{\partial y} \right), \\ \varepsilon_{zz} &= \frac{\partial u_z}{\partial z}, & \varepsilon_{zx} &= \frac{1}{2} \left(\frac{\partial u_z}{\partial x} + \frac{\partial u_x}{\partial z} \right), & \varepsilon_{zy} &= \frac{1}{2} \left(\frac{\partial u_z}{\partial y} + \frac{\partial u_y}{\partial z} \right). \end{aligned} \quad (1.44)$$

This completes the system of basic field equations. The total number of unknowns is 22 (9 stresses, 9 strains, 3 displacements and the pore pressure), and the total number of equations is also 22 (6 equilibrium equations, 9 compatibility equations, 6 independent stress-strain-relations, and the storage equation).

The system of equations can be simplified considerably by eliminating the stresses and the strains, finally expressing the equilibrium equations in the displacements. For a homogeneous material (with K and G being constants) these equations are

$$\begin{aligned} (K + \frac{1}{3}G) \frac{\partial \varepsilon}{\partial x} + G \nabla^2 u_x - \alpha \frac{\partial p}{\partial x} + f_x &= 0, \\ (K + \frac{1}{3}G) \frac{\partial \varepsilon}{\partial y} + G \nabla^2 u_y - \alpha \frac{\partial p}{\partial y} + f_y &= 0, \\ (K + \frac{1}{3}G) \frac{\partial \varepsilon}{\partial z} + G \nabla^2 u_z - \alpha \frac{\partial p}{\partial z} + f_z &= 0, \end{aligned} \quad (1.45)$$

where the volume strain ε can be expressed as

$$\varepsilon = \frac{\partial u_x}{\partial x} + \frac{\partial u_y}{\partial y} + \frac{\partial u_z}{\partial z}. \quad (1.46)$$

The complete system of differential equations consists of the storage equation (1.36) and the equilibrium equations (1.45). These are four equations with four variables: p , u_x , u_y and u_z . It may be noted that the volume strain ε is not an independent variable, see equation (1.46).

An interesting additional relation can be obtained by differentiating the first equation with respect to x , the second with respect to y , and the third with respect to z , and then adding the three equations. If the body forces are constant this gives

$$(K + \frac{4}{3}G) \nabla^2 \varepsilon = \alpha \nabla^2 p. \quad (1.47)$$

The two equations (1.36) and (1.47) are a set of two simple equations in two variables, the volume strain ε and the pore pressure p . This seems to be an advantage over the four equations considered before, but usually this gives not much help in solving problems, because the boundary conditions usually are expressed in terms of displacements or stresses, not in terms of the volume strain.

Actually, the volume strain ε can be eliminated from the two equations (1.36) and (1.47). This gives

$$\frac{\partial}{\partial t} \nabla^2 p = c_v \nabla^2 \nabla^2 p, \quad (1.48)$$

where c_v is the *consolidation coefficient*,

$$c_v = \frac{k}{\gamma_w} \frac{K + \frac{4}{3}G}{\alpha^2 + (K + \frac{4}{3}G)S}. \quad (1.49)$$

In many publications on problems of soil mechanics the stiffness of the soil is characterized by the confined compressibility m_v , which can be measured in a confined compression test, or oedometer test. Using the equations of isotropic elastic deformations it can be shown that for a vertical deformation with lateral confinement (i.e. both horizontal strains zero),

$$m_v = \frac{1}{K + \frac{4}{3}G}. \quad (1.50)$$

It follows that the consolidation coefficient c_v can also be expressed as

$$c_v = \frac{k}{\gamma_w(\alpha^2 m_v + S)}. \quad (1.51)$$

If the fluid and the particles are incompressible, the storativity S is zero, see equation (1.28), and Biot's coefficient $\alpha = 1$, see equation (1.14). In that case the consolidation coefficient reduces to

$$c_v = \frac{k}{\gamma_w m_v}, \quad (1.52)$$

which is the classical value in Terzaghi's theory (Terzaghi, 1923).

1.7 Initial conditions and boundary conditions

To solve a particular problem of poroelasticity initial conditions must be specified, and also boundary conditions.

The most common initial conditions are that the pore pressure p and the three displacement components u_x , u_y and u_z are given at a certain time, usually at time $t = 0$. It is often most convenient to assume that at $t = 0$ all these quantities are zero. This means that the pore pressure and the displacements at a later instant of time are all considered with reference to the initial state.

Because the differential equations are 4 linear equations the boundary conditions should specify 4 conditions. The most common system is that one boundary condition refers to the pore pressure: either the pore pressure or the flow rate normal to the boundary must be specified, although it may also be that the pore pressure boundary condition gives a relation between the flow rate normal to the boundary and the pore pressure. The other three conditions refer to the solid material: either the 3 surface tractions or the 3 displacement components must be prescribed (or some combination). Many analytical solutions of consolidation problems have been obtained and published, mainly for bodies of relatively simple geometry (one-dimensional bodies, half-spaces, half-planes, cylinders, spheres, etc.). (for references see Schiffman, 1984; Wang, 2000). Several solutions will be given in this book as well. For more complex geometries or more complex boundary conditions numerical methods of solution may be applied. These are also described in this book.

1.8 Drained deformations

In some cases the analysis of consolidation is not really necessary because the duration of the consolidation process is short compared to the time scale of the problem considered. This can be investigated by evaluating

the expression $c_v t/h^2$, where h is the average drainage length, and t is a characteristic time. When the value of this parameter is large compared to 1, the consolidation process will be finished after a time t , and consolidation may be disregarded. In such cases the behaviour of the soil is said to be *fully drained*. No excess pore pressures need to be considered for the analysis of the behaviour of the soil. Problems for which consolidation is so fast that it can be neglected are for instance the building of an embankment or a foundation on a sandy subsoil, provided that the smallest dimension of the structure, which determines the drainage length, is not more than say a few meters.

1.9 Undrained deformations

Quite another class of problems is concerned with the rapid loading of a soil of low permeability (for instance a clay layer). Then it may be that for some time there is hardly any movement of the fluid, and the consolidation process can be simplified in the following way. The basic equation involving the time scale is the storage equation (1.27),

$$\alpha \frac{\partial \varepsilon}{\partial t} + S \frac{\partial p}{\partial t} = -\nabla \cdot \mathbf{q}, \quad (1.53)$$

If this equation is integrated over a short time interval Δt one obtains

$$\alpha \varepsilon_0 + S p_0 = - \int_0^{\Delta t} \nabla \cdot \mathbf{q} dt, \quad (1.54)$$

where ε_0 and p_0 denote the volume strain and the pore pressure immediately after application of the load. The term in the right hand side represents the net outward flow, over a time interval Δt . When the permeability is very small, and the time step Δt is also very small, this term will be very small, and may be neglected. It follows that

$$p_0 = -\frac{\alpha \varepsilon_0}{S} = -\frac{\alpha \varepsilon_0}{nC_f + (\alpha - n)C_s}. \quad (1.55)$$

This expression enables to eliminate the pore pressure from the other equations, such as the equations of equilibrium (1.45). This gives

$$\begin{aligned} (K_u + \frac{1}{3}G) \frac{\partial \varepsilon}{\partial x} + G \nabla^2 u_x + f_x &= 0, \\ (K_u + \frac{1}{3}G) \frac{\partial \varepsilon}{\partial y} + G \nabla^2 u_y + f_y &= 0, \\ (K_u + \frac{1}{3}G) \frac{\partial \varepsilon}{\partial z} + G \nabla^2 u_z + f_z &= 0, \end{aligned} \quad (1.56)$$

where

$$K_u = K + \frac{\alpha^2}{S} = K + \frac{\alpha^2}{nC_f + (\alpha - n)C_s}, \quad (1.57)$$

the *undrained compression modulus*.

These equations are completely equivalent to the equations of equilibrium for an elastic material, the only difference being that the compression modulus K has been replaced by K_u .

Combination of eqs. (1.40) and (1.41) with (1.55) leads to the following relations between the total stresses and the displacements

$$\begin{aligned} \sigma_{xx} &= -(K_u - \frac{2}{3}G)\varepsilon - 2G\varepsilon_{xx}, & \sigma_{xy} &= -2G\varepsilon_{xy}, & \sigma_{xz} &= -2G\varepsilon_{xz}, \\ \sigma_{yy} &= -(K_u - \frac{2}{3}G)\varepsilon - 2G\varepsilon_{yy}, & \sigma_{yz} &= -2G\varepsilon_{yz}, & \sigma_{yx} &= -2G\varepsilon_{yx}, \\ \sigma_{zz} &= -(K_u - \frac{2}{3}G)\varepsilon - 2G\varepsilon_{zz}, & \sigma_{zx} &= -2G\varepsilon_{zx}, & \sigma_{zy} &= -2G\varepsilon_{zy}. \end{aligned} \quad (1.58)$$

These equations also correspond precisely to the standard relations between stresses and displacements from the classical theory of elasticity, again with the exception that K must be replaced by K_u , the undrained compression modulus. It may be concluded that the total stresses and the displacements immediately after the time of loading at time $t = 0$ can be determined by an elastic computation, with the compression modulus

K replaced by K_u . The shear modulus G remains unaffected. This type of computation is called an *undrained analysis*.

After execution of an undrained analysis the pore pressures at time $t = 0$ can be calculated using the relation (1.55). This gives

$$t = 0 : p_0 = -\frac{\alpha\varepsilon_0}{S} = \frac{\alpha\sigma_0}{K_u S} = \frac{\alpha\sigma_0}{\alpha^2 + KS}, \quad (1.59)$$

where K is the original compression modulus.

If the fluid and the particles are incompressible, the storativity S is zero, see equation (1.28). In that case the undrained compression modulus is infinitely large, which is in agreement with the physical basis of the original consolidation theory. If the particles and the fluid are incompressible, and the loading process is very fast, no drainage can occur. In that case the soil must indeed be incompressible. In an undrained analysis the material behaves with a shear modulus equal to the drained shear modulus, but with a compression modulus that is practically infinite. In terms of shear modulus and Poisson's ratio, one may say that Poisson's ratio ν is (almost) equal to 0.5 when the soil is undrained.

It may be noted that of the 3 expressions for the initial pore pressure given in equation (1.59) the third one is the most useful. The other two may contain a factor $0/0$ or a factor $\infty * 0$.

Because some of the parameters introduced above are interrelated, for instance $C_m = 1/K$ and $\alpha = 1 - C_s/C_m$, some of the equations can be given in different (but equivalent) forms. The undrained compression modulus K_u , as given here in the form (1.57), can also be expressed as

$$K_u = \frac{K}{1 - \alpha B}, \quad (1.60)$$

where B is Skempton's coefficient, defined in equation (1.10). Several other relations are given by Rice & Cleary (1976) and by Wang (2000), also including the relations with some of Biot's original coefficients, see for instance Biot & D.G. Willis (1957).

Example

As an example of an undrained analysis one may consider the case of a rigid circular foundation plate on a semi-infinite elastic porous material, loaded by a total load P , see Figure 1.4. This is a well known problem from the theory of elasticity (Timoshenko & Goodier, 1970). The settlement of the plate is

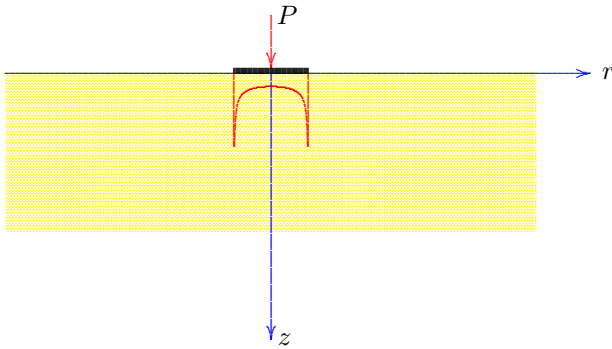

$$w = \frac{P(1 - \nu^2)}{ED}, \quad (1.61)$$

where D is the diameter of the plate. This is the settlement if there were no pore pressures, or when all the pore pressures have been dissipated. In terms of the shear modulus G and Poisson's ratio ν this formula may be written as

$$w = \frac{P(1 - \nu)}{2GD}. \quad (1.62)$$

Figure 1.4: Rigid plate on half space.

This is the settlement after the consolidation process has been completed, which may be denoted by w_∞ . At the moment of loading the material reacts as if $\nu = \frac{1}{2}$, so that the immediate settlement is

$$w_0 = \frac{P}{4GD}. \quad (1.63)$$

This shows that the ratio of the immediate settlement to the final settlement is

$$\frac{w_0}{w_\infty} = \frac{1}{2(1 - \nu)}. \quad (1.64)$$

Thus the immediate settlement is about 50 % of the final settlement, or more, depending upon the value of Poisson's ratio in drained conditions. The consolidation process will account for the remaining part of the settlement, which will be less than 50 %. It appears that some important aspects of a poroelastic problem, in particular the immediate settlement and the final settlement, may be obtained from elastic computations.

1.10 Uncoupled consolidation

In general the system of equations of three-dimensional consolidation involves solving the storage equation together with the three equations of equilibrium, simultaneously, because these equations are coupled. This may be a formidable task, and it seems worthwhile to try to simplify this procedure. It would be very convenient, for instance, if it could be shown that in the storage equation

$$\alpha \frac{\partial \varepsilon}{\partial t} + S \frac{\partial p}{\partial t} = \nabla \cdot \left(\frac{k}{\gamma_w} \nabla p \right), \quad (1.65)$$

the first term can be expressed as

$$\frac{\partial \varepsilon}{\partial t} = C \frac{\partial p}{\partial t}, \quad (1.66)$$

where C is some constant, because then the equation reduces to the form

$$(\alpha C + S) \frac{\partial p}{\partial t} = \nabla \cdot \left(\frac{k}{\gamma_w} \nabla p \right), \quad (1.67)$$

which is the classical diffusion equation, for which many analytical solutions are available. The system of equations is then uncoupled, in the sense that first the pore pressure can be determined from equation (1.67) and the boundary conditions for the pore pressure, and then later the deformation problem can be solved using the equations of equilibrium, in which then the gradient of the pore pressure acts as a known body force. Several conditions for uncoupling are considered below, see also Detournay & Cheng (1993) and Wang (2000).

1.10.1 Constant isotropic total stress

A first possibility for uncoupling is obtained by noting that for an isotropic material the volume strain ε is a function of the isotropic effective stress σ' ,

$$\sigma' = \frac{\sigma'_{xx} + \sigma'_{yy} + \sigma'_{zz}}{3}. \quad (1.68)$$

For a linear material the relation may be written as

$$\varepsilon = -C_m \sigma', \quad (1.69)$$

where C_m is the compressibility of the porous material, the inverse of its compression modulus, $C_m = 1/K$, and the minus sign is needed because of the different sign conventions used for stresses and strains. The effective stress is the difference between total stress and pore pressure (taking into account Biot's coefficient), and thus one may write

$$\varepsilon = -C_m (\sigma - \alpha p), \quad (1.70)$$

Differentiating this with respect to time gives

$$\frac{\partial \varepsilon}{\partial t} = -C_m \frac{\partial \sigma}{\partial t} + \alpha C_m \frac{\partial p}{\partial t}. \quad (1.71)$$

If it is now assumed, as a first approximation, that the isotropic total stress is constant in time, then there indeed appears to be a relation of the type (1.66), with

$$C = \alpha C_m. \quad (1.72)$$

The differential equation now is, with (1.67)

$$(\alpha^2 C_m + S) \frac{\partial p}{\partial t} = \nabla \cdot \left(\frac{k}{\gamma_w} \nabla p \right), \quad (1.73)$$

which is indeed a diffusion equation. This simplifying assumption was first suggested by Rendulic (1936), see also Gibson & Lumb (1953). That the isotropic total stress remains approximately constant in time is

not unrealistic for certain problems. In many cases consolidation takes place while the loading of the soil remains constant, and although there may be a certain redistribution of stress, it may well be assumed that the changes in total stress will be small. A mathematical proof is impossible to give, however, and it is also difficult to say under what conditions the approximation is acceptable. Various solutions of coupled three-dimensional problems have been obtained, and in many cases a certain difference with the uncoupled solution has been found. Sometimes there is even a very pronounced difference in behaviour for small values of the time, in the sense that sometimes the pore pressures initially show a certain increase, before they dissipate. This is the *Mandel-Cryer* effect, see Chapter 3. which is a typical consequence of the coupling effect. When the pore pressures at the boundary start to dissipate the local deformation may lead to an immediate effect in other parts of the soil body, and this may lead to an additional pore pressure. In the long run the pore pressures always dissipate, however, and the difference with the uncoupled solution then is often not important. Therefore an uncoupled analysis may be a good first approximation, if it is realized that local errors may occur, especially for short values of time.

An uncoupled analysis may also be very useful as a preconditioner for a numerical solution, for instance by finite elements. The coupled finite element equations often lead to a system of linear equations that is ill-conditioned. A first approximation using a simpler and better conditioned system of equations may be very helpful, and Rendulic's approximation may be a good candidate for such a preconditioner, see Chapter 9.

1.10.2 Horizontally confined deformations

Another important class of problems in which an uncoupled analysis is justified, at least as a first approximation, is the case where it can be assumed that the horizontal deformations will be negligible, and the vertical total stress remains constant. In the case of a soil layer of large horizontal extent, loaded by a constant surface load, this may be an acceptable set of assumptions. If the horizontal deformations are set equal to zero, it follows that the volume strain is equal to the vertical strain,

$$\varepsilon = \varepsilon_{zz}. \quad (1.74)$$

For a linear elastic material the vertical strain can be related to the vertical effective stress by the formula

$$\varepsilon_{zz} = -m_v \sigma'_{zz}, \quad (1.75)$$

where m_v is the vertical compressibility of a laterally confined soil sample. Using the effective stress principle this now gives

$$\varepsilon_{zz} = -m_v(\sigma_{zz} - \alpha p), \quad (1.76)$$

and therefore

$$\frac{\partial \varepsilon}{\partial t} = -m_v \frac{\partial \sigma_{zz}}{\partial t} + \alpha m_v \frac{\partial p}{\partial t}. \quad (1.77)$$

Substitution into the storage equation (1.65) gives

$$(\alpha^2 m_v + S) \frac{\partial p}{\partial t} = \alpha m_v \frac{\partial \sigma_{zz}}{\partial t} + \nabla \cdot \left(\frac{k}{\gamma_w} \nabla p \right). \quad (1.78)$$

This equation is indeed of the form of a diffusion equation if the vertical total stress is constant. It may be concluded that in the case of zero lateral deformation and constant vertical total stress the consolidation equations are uncoupled. If the medium is homogeneous, the coefficient k/γ_w is constant in space, and then the differential equation reduces to the form

$$\frac{\partial p}{\partial t} = c_v \nabla^2 p, \quad (1.79)$$

where ∇^2 is Laplace's operator,

$$\nabla^2 = \frac{\partial}{\partial x^2} + \frac{\partial}{\partial y^2} + \frac{\partial}{\partial z^2}, \quad (1.80)$$

and c_v is the consolidation coefficient,

$$c_v = \frac{k}{(\alpha^2 m_v + S) \gamma_w}. \quad (1.81)$$

An equation of the form (1.79) was first derived by Terzaghi (1923, 1925), for the one-dimensional case of flow and deformation in the vertical direction only, as occurs in a confined compression test in the laboratory, or in the consolidation of an extensive clay layer in the field, loaded by a uniform surcharge. It was also derived by Jacob (1940), using somewhat different notations, for the deformation of a compressible aquifer of thickness H , transmissivity T , and storativity S , due to the groundwater flow. The consolidation coefficient then can be written as $c_v = T/S$. In this case, the assumption of zero horizontal displacements seems to be difficult to reconcile with the horizontal flow of the groundwater. A model allowing for horizontal displacements is considered in section 5.5.

1.10.3 Highly compressible fluid

In the storage equation

$$\alpha \frac{\partial \varepsilon}{\partial t} + S \frac{\partial p}{\partial t} = \nabla \cdot \left(\frac{k}{\gamma_w} \nabla p \right), \quad (1.82)$$

the second term in the left hand side of the equation represents the volume change of the fluid in the pores due to the compression of the fluid, with the storativity defined by equation (1.28),

$$S = nC_f + (\alpha - n)C_s, \quad (1.83)$$

where C_f is the compressibility of the fluid and C_s is the compressibility of the solid particles. In soft soils, such as clay or sand, the storativity will usually be small, and the soil may be very compressible, so that the term $S \partial p / \partial t$ will be small compared to the first term $\alpha \partial \varepsilon / \partial t$. However, in very stiff materials, such as porous rock, with a highly compressible fluid in the pores (especially a gas) the second term may dominate the first one. If the deformation of the porous material is disregarded (as a first approximation) the storage equation reduces to

$$S \frac{\partial p}{\partial t} = \nabla \cdot \left(\frac{k}{\gamma_w} \nabla p \right), \quad (1.84)$$

which is just the form of the heat conduction equation. This case of uncoupled poroelasticity is of considerable importance for reservoir engineering (Dake, 1978).

1.10.4 Irrotational deformations

The case of irrotational deformations as a possibility for uncoupling the consolidation equations was first mentioned by Biot (1956) and further elaborated by De Josselin de Jong (1963) and by Sills (1975). The deformations will be everywhere irrotational if

$$\frac{\partial u_x}{\partial y} = \frac{\partial u_y}{\partial x}, \quad \frac{\partial u_y}{\partial z} = \frac{\partial u_z}{\partial y}, \quad \frac{\partial u_z}{\partial x} = \frac{\partial u_x}{\partial z}. \quad (1.85)$$

It then follows that there exists a single-valued potential Φ such that

$$u_x = \frac{\partial \Phi}{\partial x}, \quad u_y = \frac{\partial \Phi}{\partial y}, \quad u_z = \frac{\partial \Phi}{\partial z}, \quad (1.86)$$

from which it follows that the volume strain is

$$\varepsilon = \frac{\partial u_x}{\partial x} + \frac{\partial u_y}{\partial y} + \frac{\partial u_z}{\partial z} = \nabla^2 \Phi. \quad (1.87)$$

In the absence of body forces the equations of equilibrium (1.45) are

$$\begin{aligned} (K + \frac{1}{3}G) \frac{\partial \varepsilon}{\partial x} + G \nabla^2 u_x - \alpha \frac{\partial p}{\partial x} &= 0, \\ (K + \frac{1}{3}G) \frac{\partial \varepsilon}{\partial y} + G \nabla^2 u_y - \alpha \frac{\partial p}{\partial y} &= 0, \\ (K + \frac{1}{3}G) \frac{\partial \varepsilon}{\partial z} + G \nabla^2 u_z - \alpha \frac{\partial p}{\partial z} &= 0. \end{aligned} \quad (1.88)$$

Using equations (1.86) it follows that

$$\begin{aligned}\nabla^2 u_x &= \frac{\partial^2 u_x}{\partial x^2} + \frac{\partial^2 u_x}{\partial y^2} + \frac{\partial^2 u_x}{\partial z^2} = \frac{\partial^2 u_x}{\partial x^2} + \frac{\partial^2 u_y}{\partial x \partial y} + \frac{\partial^2 u_z}{\partial x \partial z} = \frac{\partial \varepsilon}{\partial x}, \\ \nabla^2 u_y &= \frac{\partial^2 u_y}{\partial x^2} + \frac{\partial^2 u_y}{\partial y^2} + \frac{\partial^2 u_y}{\partial z^2} = \frac{\partial^2 u_x}{\partial x \partial y} + \frac{\partial^2 u_y}{\partial y^2} + \frac{\partial^2 u_z}{\partial z \partial y} = \frac{\partial \varepsilon}{\partial y}, \\ \nabla^2 u_z &= \frac{\partial^2 u_z}{\partial x^2} + \frac{\partial^2 u_z}{\partial y^2} + \frac{\partial^2 u_z}{\partial z^2} = \frac{\partial^2 u_x}{\partial x \partial z} + \frac{\partial^2 u_y}{\partial y \partial z} + \frac{\partial^2 u_z}{\partial z^2} = \frac{\partial \varepsilon}{\partial z}.\end{aligned}\tag{1.89}$$

Equations (1.88) now can be written as

$$\left(K + \frac{4}{3}G\right) \frac{\partial \varepsilon}{\partial x} + \alpha \frac{\partial p}{\partial x} = 0,$$

$$\left(K + \frac{4}{3}G\right) \frac{\partial \varepsilon}{\partial y} + \alpha \frac{\partial p}{\partial y} = 0,\tag{1.90}$$

$$\left(K + \frac{4}{3}G\right) \frac{\partial \varepsilon}{\partial z} + \alpha \frac{\partial p}{\partial z} = 0,\tag{1.91}$$

It follows that

$$\left(K + \frac{4}{3}G\right) \varepsilon - \alpha p = g(t),\tag{1.92}$$

where $g(t)$ is an integration constant, which may depend upon time t , but not on the spatial coordinates. If a point can be found where ε and p are given, for instance from a boundary condition, then the function $g(t)$ can be obtained from that condition. An example is the problem of a point sink or a point source in an infinite field. Then it can be expected that at infinity $\varepsilon = p = 0$, and it follows that $g(t) = 0$. It should be mentioned that this is practically the only non-trivial example. And a solution of this problem, of a point source in an infinite field, can directly be solved by introducing spherical coordinates, see section 3.5.

The one-dimensional deformation of a soil sample may also be considered as an example of irrotational deformations, and the equations are indeed uncoupled, but problems of this type have already been included in the Terzaghi-Jacob model, see section 1.10.2.

Chapter 2

ONE-DIMENSIONAL PROBLEMS

2.1 Introduction

The simplest problems of poroelasticity are problems of one-dimensional deformation, for instance vertical deformation only. The classical problem was formulated by Terzaghi (1923, 1925), in order to analyze the time delay observed when compressing clay layers. In this chapter this problem is considered, together with some generalizations.

The history of Terzaghi's theory has been discussed extensively in many of the textbooks on soil mechanics, and in particular by De Boer, Schiffman & Gibson (1996). Some of the backgrounds of the theory are discussed in section 2.3.

This chapter also contains an introduction to the numerical methods using finite differences or finite elements, for one-dimensional problems.

2.2 Terzaghi's problem

This section presents the solution of Terzaghi's consolidation problem: a confined soil sample, surrounded by a circular ring, and placed in a container filled with water. The sample is loaded by a constant vertical stress at its upper surface, and its deformation is measured. The lower boundary is impermeable, and the upper boundary is fully drained, see Figure 2.1. This is called a *confined compression test* or an *oedometer test*. It can be expected that the compression of a sample of soft soil, for instance clay, will be accompanied by an expulsion of water from the sample. And because of the low permeability of the soil, this may take considerable time.

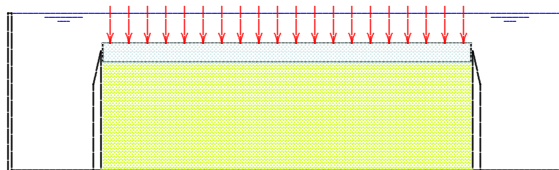

Figure 2.1: Terzaghi's problem.

In Terzaghi's original work the pore fluid and the soil particles were both assumed to be incompressible, so that the only mechanism of deformation was a rearrangement of the particles. In modern presentations these assumptions are no longer made, and this generalized theory will be presented here.

2.2.1 Statement of the problem

For one-dimensional deformation of a homogeneous porous material the basic equation is the storage equation, see equation (1.36),

$$\alpha \frac{\partial \varepsilon}{\partial t} + S \frac{\partial p}{\partial t} = \frac{k}{\gamma_f} \frac{\partial^2 p}{\partial z^2}, \quad (2.1)$$

where p is the pore pressure, ε is the volume change of the porous material, α is Biot's coefficient, S is the storativity of the pore space, k is the permeability coefficient (the hydraulic conductivity) of the porous material and γ_f is the unit weight of the pore fluid. The storativity can be expressed as

$$S = nC_f + (\alpha - n)C_s, \quad (2.2)$$

where C_f is the compressibility of the fluid and C_s is the compressibility of the particle material. Biot's coefficient can also be related to C_s by the equation

$$\alpha = 1 - C_s/C_m, \quad (2.3)$$

where C_m is the compressibility of the porous medium, the inverse of its compression modulus K ,

$$C_m = 1/K, \quad (2.4)$$

In the case of one-dimensional deformation the volume change equals the vertical strain. Assuming linear elastic behaviour this can be related to the vertical effective stress by the equation

$$\frac{\partial \varepsilon}{\partial t} = -m_v \frac{\partial \sigma'_{zz}}{\partial t} = -m_v \left(\frac{\partial \sigma_{zz}}{\partial t} - \alpha \frac{\partial p}{\partial t} \right), \quad (2.5)$$

where m_v is the confined compressibility of the porous medium,

$$m_v = \frac{1}{K + \frac{4}{3}G}, \quad (2.6)$$

where K and G are the compression modulus and the shear modulus of the porous medium.

Elimination of the volume strain rate $\partial \varepsilon / \partial t$ from equations (2.1) and (2.5) gives

$$\frac{\partial p}{\partial t} = \frac{\alpha m_v}{S + \alpha^2 m_v} \frac{\partial \sigma_{zz}}{\partial t} + \frac{k}{\gamma_f (S + \alpha^2 m_v)} \frac{\partial^2 p}{\partial z^2}. \quad (2.7)$$

This is the general differential equation for one-dimensional consolidation.

The classical problem is that at time $t = 0$ a vertical load of magnitude q is applied, and this load is maintained for $t > 0$. This means that for $t > 0$ the total stress σ_{zz} is constant, so that equation (2.7) reduces to

$$t > 0 : \frac{\partial p}{\partial t} = c_v \frac{\partial^2 p}{\partial z^2}, \quad (2.8)$$

where c_v is the consolidation coefficient,

$$c_v = \frac{k}{\gamma_f (S + \alpha^2 m_v)}. \quad (2.9)$$

Equation (2.8) is Terzaghi's basic equation of one-dimensional consolidation under constant total stress.

The initial condition can be established by noting that at the moment of loading there can not yet have been any fluid loss from the soil, so that it follows from equation (2.7), ignoring the contribution of the second term on the right hand side, that

$$t = 0 : p = p_0 = \frac{\alpha m_v}{S + \alpha^2 m_v} q, \quad (2.10)$$

which is the initial condition of the problem. If the fluid and the solid particles are incompressible $\alpha = 1$ and $S = 0$, so that then $p_0 = q$, as was considered in the original works by Terzaghi.

The boundary condition at the bottom of the sample is

$$t > 0, z = 0 : \frac{\partial p}{\partial z} = 0, \quad (2.11)$$

The boundary condition at the top of the sample is

$$t > 0, z = h : p = 0. \quad (2.12)$$

2.2.2 Solution of the problem

The problem can most conveniently be solved using the Laplace transform (Churchill, 1972)

$$\bar{p} = \int_0^\infty p \exp(-st) dt. \quad (2.13)$$

The partial differential equation (2.8) then is transformed into

$$\frac{d^2 \bar{p}}{dz^2} = \lambda^2 (\bar{p} - \frac{p_0}{s}), \quad (2.14)$$

where

$$\lambda^2 = s/c_v. \quad (2.15)$$

The solution of this equation is

$$\bar{p} = \frac{p_0}{s} + A \cosh(\lambda z) + B \sinh(\lambda z), \quad (2.16)$$

where A and B are integration constants, independent of z .

Because of the boundary condition (2.11) the constant $B = 0$. Furthermore, it follows from the boundary condition (2.12) that $A = -p_0/[\cosh(\lambda h)]$. The solution (2.16) then becomes

$$\bar{p} = \frac{p_0}{s} - \frac{p_0 \cosh(\lambda z)}{s \cosh(\lambda h)}. \quad (2.17)$$

The inverse transformation of the expression (2.17) can best be performed using the complex inversion integral

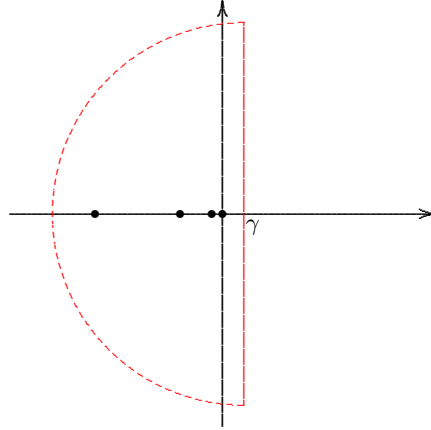

Figure 2.2: Integration path in the complex s -plane.

(Churchill, 1972)

$$p = \frac{1}{2\pi i} \int_{\gamma-i\infty}^{\gamma+i\infty} \bar{p} \exp(st) ds, \quad (2.18)$$

where γ is such that there are no singularities to the right of the integration path, see Figure 2.2.

The integral can be evaluated by completing the integration path to a closed contour, with a large half-circle to the left of the integration path (dashed in the figure). Assuming that the contribution of the half-circle to the integral vanishes, and assuming that the integrand is single-valued, it follows from the residue-theorem (Churchill, 1972) that the integral equals the sum of the residues in all the poles inside the contour,

$$p = \sum_k \text{Res}\{\bar{p} \exp(st)\}. \quad (2.19)$$

The first term of equation (2.17) has only one pole, at $s = 0$, and the residue at that pole is p_0 . The second term has a pole at $s = 0$, and poles at the zeroes of the function $\cosh(\lambda h)$. These zeroes are

$$\lambda_k = (2k-1) \frac{i\pi}{2h}, \quad s_k = -(2k-1)^2 \frac{c\pi^2}{4h^2}, \quad k = 1, 2, 3, \dots \quad (2.20)$$

The residue at the pole $s = 0$ of the second term is $-p_0$, which cancels the contribution of the first term. The residue at the simple pole $s = s_k$ is

$$\text{Res}_k = \left\{ -\frac{p_0 \cosh(\lambda z) \exp(st)}{d\{s \cosh(\lambda h)\}/ds} \right\}_{s=s_k} \quad (2.21)$$

Because

$$\frac{d}{ds} \cosh(\lambda h) = h \sinh(\lambda h) \frac{d\lambda}{ds}, \quad (2.22)$$

and

$$\frac{d\lambda}{ds} = \frac{d\sqrt{s/c_v}}{ds} = \frac{1}{2\sqrt{sc_v}} = \frac{1}{2\lambda c_v}, \quad (2.23)$$

it follows that

$$\text{Res}_k = -\frac{2\lambda_k c_v p_0 \cosh(\lambda_k z) \exp(s_k t)}{s_k h \sinh(\lambda_k h)}, \quad (2.24)$$

or, with (2.20),

$$\text{Res}_k = \frac{4p_0}{\pi} \frac{(-1)^{k-1}}{2k-1} \cos\left[(2k-1)\frac{\pi z}{2h}\right] \exp\left[-(2k-1)^2 \frac{\pi^2}{4} \frac{c_v t}{h^2}\right]. \quad (2.25)$$

It follows that the complete solution of the problem is

$$\frac{p}{p_0} = \frac{4}{\pi} \sum_{k=1}^{\infty} \frac{(-1)^{k-1}}{2k-1} \cos\left[(2k-1)\frac{\pi z}{2h}\right] \exp\left[-(2k-1)^2 \frac{\pi^2}{4} \frac{c_v t}{h^2}\right]. \quad (2.26)$$

This is a well known result, that can be found in many basic textbooks on soil mechanics. It should be noted that in some presentations the thickness of the sample is denoted by $2h$, and both the upper and lower boundaries are considered fully drained. The center of the sample then is located at $z = h$, and because of the symmetry there is no flow at this location.

For small values of the time parameter $c_v t/h^2$, say $c_v t/h^2 < 0.01$, the series in the solution (2.26) converges very slowly. It is then more convenient to use an approximation that is especially suitable for small values of time (Carslaw & Jaeger, 1948; p. 255). This approximation uses the property following from the definition of the Laplace transform, see equation (2.13), that for large values of s the function $\exp(-st)$ will approach zero for reasonably small values of time, so that the Laplace transform can be expected to derive its value mainly from values of the function $F(t)$ for small values of time. Thus, it can be expected that by assuming s to be very large in the Laplace transform an approximation of the function $F(t)$ for small values of time may be obtained. This argument is further developed to a full alternative series expansion in the literature (Carslaw & Jaeger, 1948; Churchill, 1972). In the present case an approximation for large values of s of the Laplace transform expression (2.17) is

$$\bar{p} \approx \frac{p_0}{s} - \frac{p_0}{s} \exp[-(h-z)\sqrt{s/c_v}]. \quad (2.27)$$

Inverse Laplace transformation, using a standard Laplace transform (Churchill, 1972), gives

$$ct/h^2 \ll 1 : \frac{p}{p_0} \approx \text{erf}\left(\frac{h-z}{2\sqrt{c_v t}}\right). \quad (2.28)$$

2.2.3 Numerical results

For the computation of numerical values the two forms of the solution have been used to develop a computer program. Figure 2.3 shows the pore pressure p/p_0 as a function of the two basic parameters z/h and $c_v t/h^2$.

It can be observed from this figure that for $c_v t/h^2 = 2$ the pore pressures have been reduced to almost zero. This means that the consolidation process of the sample is practically finished if $t \approx 2h^2/c_v$.

2.2.4 Numerical solution by finite difference method

As an alternative for the analytical solution presented above a numerical method may be considered. The simplest method is the finite difference method, which was first applied to consolidation problems by Gibson & Lumb (1953) and Abbott (1960). This method is particularly convenient for one-dimensional problems.

The basic differential equation is equation (2.8),

$$t > 0 : \frac{\partial p}{\partial t} = c_v \frac{\partial^2 p}{\partial z^2}, \quad (2.29)$$

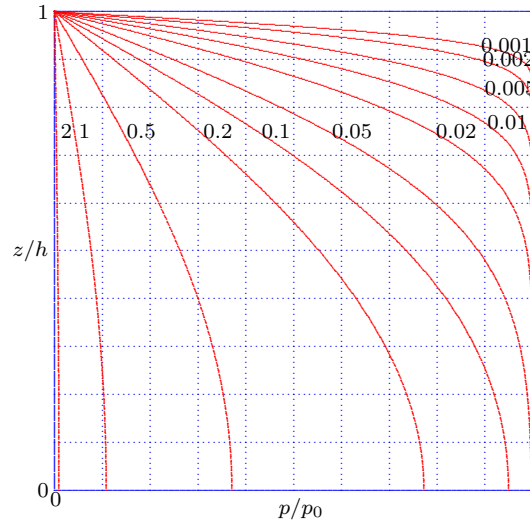

Figure 2.3: Terzaghi's problem : Pore pressure as a function of z/h and ct/h^2 .

with the boundary conditions

$$z = 0 : \frac{\partial p}{\partial z} = 0, \quad (2.30)$$

$$z = h : p = 0, \quad (2.31)$$

and the initial condition is

$$t = 0 : p = p_0. \quad (2.32)$$

In the finite difference method the partial differentiations in equation (2.29) are approximated by finite differences. This gives

$$\frac{p(z, t + \Delta t) - p(z, t)}{\Delta t} = c \frac{p(z + \Delta z, t) - 2p(z, t) + p(z - \Delta z, t)}{(\Delta z)^2}. \quad (2.33)$$

When writing $p(z, t) = p_i(t)$, $p(z + \Delta z, t) = p_{i+1}(t)$ and $p(z - \Delta z, t) = p_{i-1}(t)$ this equation can be written as

$$p_i(t + \Delta t) = p_i(t) + \delta \{p_{i+1}(t) - 2p_i(t) + p_{i-1}(t)\}, \quad (2.34)$$

where

$$\delta = \frac{c_v \Delta t}{(\Delta z)^2}. \quad (2.35)$$

If the values of the pore pressure at time $t = 0$ are known, as they are, from the boundary condition (2.32), for $i = 0, \dots, n$, the values at time $t = \Delta t$ can be calculated for $i = 1, \dots, n - 1$. The value for $i = n$ follows from the boundary condition at the top, equation (2.30), and the value for $i = 0$ can be calculated from the boundary condition at the bottom, equation (2.31). The simplest way to do that is to introduce an extra value just below this boundary, for $i = -1$, assuming that $p_{-1} = p_1$, and then calculating p_0 from the algorithm (2.34) for $i = 0$. The symmetry condition then ensures that the first boundary condition is indeed satisfied. After calculating the values at time $t = \Delta t$ a next step can be made to calculate the values at time $t = 2\Delta t$, and so on.

It may be noted that the simplicity of the procedure is a consequence of taking the values of the pressure in the right hand side of equation (2.33) or (2.34) all at the initial moment of time t . If these are taken at time $t + \Delta t$, or at some intermediate time, a more complex algorithm would have obtained, in which the new values of the pressure have to be calculated from a system of linear equations. Such an approach is called an *implicit* procedure. The explicit procedure used here is the simplest, and often sufficiently accurate, provided that the process is stable.

Stability

The numerical algorithm (2.34) is stable only if the value of δ is small enough. If this value is taken too large the process will become unstable, leading to fluctuating values of ever increasing magnitude, see for instance Fox (1962). The stability criterion can be derived by assuming a state of zero pore pressures, and then requiring that this is maintained. If it is assumed that there is a small error, with $p_{i-1}(t) = \varepsilon$, $p_i(t) = -\varepsilon$ and $p_{i+1}(t) = \varepsilon$, it follows from equation (2.34) that

$$p_i(t + \Delta t) = (1 - 4\delta)\varepsilon. \quad (2.36)$$

This is always smaller than ε provided that $\delta > 0$, which means that the time step must be positive, which is a trivial condition. The value of $p_i(t + \Delta t)$ must also be larger than $-\varepsilon$, however, if the process is not to lead to ever increasing fluctuations. This leads to the condition

$$\delta < 0.5. \quad (2.37)$$

This means that the time steps must satisfy the condition

$$\Delta t < \frac{(\Delta z)^2}{2c_v}. \quad (2.38)$$

This condition should always be satisfied when using the algorithm (2.34).

Figure 2.4 shows a comparison of the analytical solution and the numerical solution using finite differences. It appears that the agreement is excellent. Because of the simplicity of the numerical method it is widely used.

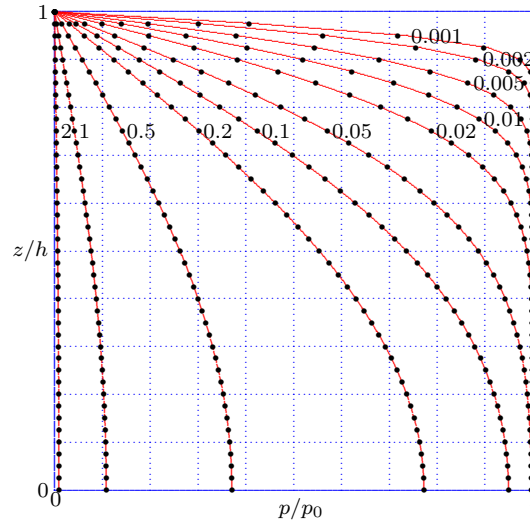

Figure 2.4: Terzaghi's problem : comparison of analytical and numerical solution.

Unfortunately, the finite difference method is not so well suited for a non-homogeneous material, for instance a layered soil. For such problems the finite element method is more convenient. This will be presented in section 2.6.

2.2.5 The deformation

The vertical strain is, with equation (2.5),

$$\varepsilon = -m_v \sigma'_{zz} = -m_v (\sigma_{zz} - \alpha p), \quad (2.39)$$

where the quantities ε , σ'_{zz} , σ_{zz} and p are increments with respect to the initial state, before the application of the load.

The vertical displacement w (considered positive for compression) can be obtained by integrating the strain over the thickness of the sample,

$$w = - \int_0^h \varepsilon dz = m_v h q - m_v \int_0^h p dz. \quad (2.40)$$

The first term in the right hand side is the final displacement, reached when all the pore pressures have been dissipated. This value is denoted as w_∞ ,

$$w_\infty = m_v h q. \quad (2.41)$$

Immediately after the application of the load q the pore pressure is equal to p_0 , see equation (2.10). It follows that the immediate displacement, at the moment of loading, is

$$w_0 = m_v h q \frac{S}{S + \alpha^2 m_v}. \quad (2.42)$$

If the fluid and the particles are incompressible $S = 0$, and the initial displacement is zero.

In order to describe the displacement it is convenient to introduce a non-dimensional quantity U , the degree of consolidation,

$$U = \frac{w - w_0}{w_\infty - w_0}. \quad (2.43)$$

The degree of consolidation will vary between 0 (at the moment of loading) and 1 (after consolidation has been completed). With the expressions given before for w , w_∞ and w_0 it follows that

$$U = \frac{1}{h} \int_0^h \frac{p_0 - p}{p_0} dz. \quad (2.44)$$

Using the solution (2.26) for the pore pressure distribution the final expression for the degree of consolidation as a function of time is

$$U = 1 - \frac{8}{\pi^2} \sum_{k=1}^{\infty} \frac{1}{(2k-1)^2} \exp\left[-(2k-1)^2 \frac{\pi^2}{4} \frac{c_v t}{h^2}\right]. \quad (2.45)$$

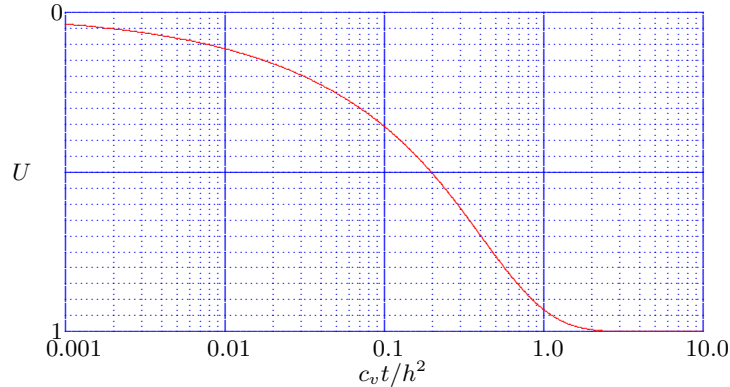

Figure 2.5: Degree of Consolidation.

Figure 2.5 shows the value of the degree of consolidation U as a function of $c_v t / h^2$, the dimensionless time. The figure confirms that the consolidation process is practically terminated for $c_v t / h^2 = 2$.

2.2.6 Gradual application of drainage

As an alternative one may consider the problem with a slightly modified boundary condition at the top of the sample,

$$t > 0, z = h : p = \begin{cases} p_0(1 - t/t_0) & \text{if } t < t_0, \\ 0 & \text{if } t > t_0. \end{cases} \quad (2.46)$$

In this case the pore pressure at the upper boundary is reduced to zero in a (small) time t_0 . This means that the pore pressure at this boundary is continuous in time.

The Laplace transform of this boundary condition is

$$z = h : \bar{p} = \frac{p_0}{s} - \frac{p_0}{s^2 t_0} [1 - \exp(-s t_0)]. \quad (2.47)$$

It can be seen that for $t_0 \rightarrow 0$ this reduces to the boundary condition of the previous problem.

The solution of the transformed differential equation is, as in the previous problem

$$\bar{p} = \frac{p_0}{s} + A \cosh(\lambda z), \quad (2.48)$$

where the second term has been omitted because of the boundary condition at the bottom of the sample.

The constant A can be determined from the boundary condition (2.46). The solution then is

$$\frac{\bar{p}}{p_0} = \frac{1}{s} - \frac{1}{s^2 t_0} \frac{\cosh(\lambda z)}{\cosh(\lambda h)} [1 - \exp(-st_0)]. \quad (2.49)$$

The inverse transform now is

$$\frac{p}{p_0} = \frac{1}{2\pi i} \int_{\gamma-i\infty}^{\gamma+i\infty} \left\{ \frac{1}{s} - \frac{1}{s^2 t_0} \frac{\cosh(\lambda z)}{\cosh(\lambda h)} [1 - \exp(-st_0)] \right\} \exp(st) ds \quad (2.50)$$

It is most convenient to determine the inverse Laplace transform by considering the three terms of the integrand separately.

The first term

The first term of the integrand is

$$P_1 = \frac{1}{s} \exp(st). \quad (2.51)$$

The inverse transform of this expression is

$$\frac{p_1}{p_0} = 1. \quad (2.52)$$

Formally the inversion integral is the sum of the residues. In this case there is a single pole at $s = 0$, and the coefficient of the power s^{-1} in a power series expansion in the vicinity of the pole is 1.

The second term

The second term of the integrand is

$$P_2 = -\frac{1}{s^2 t_0} \frac{\cosh(\lambda z)}{\cosh(\lambda h)} \exp(st). \quad (2.53)$$

This term is very similar to the second term in the previous problem, except that the factor s in the denominator has been replaced by $s^2 t_0$.

The pole $s = 0$ in this case is of the second order. Expansion of the term P_2 in a power series in the vicinity of the point $s = 0$ gives

$$P_2 = -\frac{1}{s^2 t_0} + \frac{1}{s} \left[\frac{h^2 - z^2}{2c_v t_0} - \frac{t}{t_0} \right] + \dots \quad (2.54)$$

The residue is the coefficient of the term s^{-1} . Hence

$$\text{Res}_0 = \frac{h^2 - z^2}{2c_v t_0} - \frac{t}{t_0}. \quad (2.55)$$

The integrand P_2 has a series of poles located in the points where $\cosh(\lambda h) = 0$. As before, these poles are located at the points

$$\lambda_k = (2k-1) \frac{i\pi}{2h}, \quad s_k = -(2k-1)^2 \frac{c_v \pi^2}{4h^2}, \quad k = 1, 2, 3, \dots \quad (2.56)$$

The residue at the simple pole $s = s_k$ is

$$\text{Res}_k = \left\{ -\frac{p_0 \cosh(\lambda z) \exp(st)}{d\{s^2 t_0 \cosh(\lambda h)\}/ds} \right\}_{s=s_k} \quad (2.57)$$

Because

$$\frac{d}{ds} \cosh(\lambda h) = h \sinh(\lambda h) \frac{d\lambda}{ds}, \quad (2.58)$$

and

$$\frac{d\lambda}{ds} = \frac{d\sqrt{s/c_v}}{ds} = \frac{1}{2\sqrt{sc_v}} = \frac{1}{2\lambda c_v}, \quad (2.59)$$

it follows that

$$\text{Res}_k = -\frac{2\lambda_k c_v p_0 \cosh(\lambda_k z) \exp(s_k t)}{s_k^2 t_0 h \sinh(\lambda_k h)}, \quad (2.60)$$

or, with (2.56),

$$\text{Res}_k = -\frac{16p_0}{\pi^3} \frac{(-1)^{k-1}}{(2k-1)^3 (c_v t_0/h^2)} \cos[(2k-1)\frac{\pi z}{2h}] \exp[-(2k-1)^2 \frac{\pi^2}{4} \frac{c_v t}{h^2}]. \quad (2.61)$$

The complete solution for the second term is

$$\frac{p_2}{p_0} = \frac{h^2 - z^2}{2c_v t_0} - \frac{t}{t_0} - \frac{16}{\pi^3} \sum_{k=1}^{\infty} \frac{(-1)^{k-1}}{(2k-1)^3 (c_v t_0/h^2)} \cos[(2k-1)\frac{\pi z}{2h}] \exp[-(2k-1)^2 \frac{\pi^2}{4} \frac{c_v t}{h^2}] \quad (2.62)$$

The third term

The third term of the integrand is

$$P_3 = \frac{1}{s^2 t_0} \frac{\cosh(\lambda z)}{\cosh(\lambda h)} \exp(st) \exp(-st_0). \quad (2.63)$$

This is the same as the second term, except for a minus sign and t has been replaced by $t - t_0$. This means, using a general theorem from Laplace transform theory that the inverse transform can be obtained from the inverse transform of the second term, upon replacing t by $t - t_0$, taking into account that the term is zero if $t < t_0$. Thus the third term is

$$\frac{p_3}{p_0} = -\left\{ \frac{h^2 - z^2}{2c_v t_0} - \frac{t - t_0}{t_0} - \frac{16}{\pi^3} \sum_{k=1}^{\infty} \frac{(-1)^{k-1}}{(2k-1)^3 (c_v t_0/h^2)} \cos[(2k-1)\frac{\pi z}{2h}] \times \right. \\ \left. \exp[-(2k-1)^2 \frac{\pi^2}{4} \frac{c_v (t - t_0)}{h^2}] \right\} H(t - t_0). \quad (2.64)$$

Final solution

Addition of the three terms leads to the following final form of the solution of this problem

$$t < t_0 : \frac{p}{p_0} = \frac{h^2 - z^2}{2c_v t_0} + \frac{t_0 - t}{t_0} - \frac{16}{\pi^3} \sum_{k=1}^{\infty} \frac{(-1)^{k-1}}{(2k-1)^3 (c_v t_0/h^2)} \cos[(2k-1)\frac{\pi z}{2h}] \times \\ \exp[-(2k-1)^2 \frac{\pi^2}{4} \frac{c_v t}{h^2}], \quad (2.65)$$

$$t > t_0 : \frac{p}{p_0} = -\frac{16}{\pi^3} \sum_{k=1}^{\infty} \frac{(-1)^{k-1}}{(2k-1)^3 (c_v t_0/h^2)} \cos[(2k-1)\frac{\pi z}{2h}] \times \\ \exp[-(2k-1)^2 \frac{\pi^2}{4} \frac{c_v t}{h^2}] \{1 - \exp[(2k-1)^2 \frac{\pi^2}{4} \frac{c_v t_0}{h^2}]\}. \quad (2.66)$$

This completes the solution.

Again this solution is not very suitable for very small values of time. An approximation of the Laplace transform (2.49) for large values of the transform parameter s is

$$\frac{\bar{p}}{p_0} \approx \frac{1}{s} - \frac{1}{s^2 t_0} \{ \exp[-(h-z)\sqrt{s/c_v}] \} [1 - \exp(-st_0)]. \quad (2.67)$$

Inverse transformation now leads to the following approximation for small values of $c_v t/h^2$

$$ct/h^2 \ll 1 : \frac{p}{p_0} \approx 1 - F(t) + F(t - t_0)H(t - t_0), \quad (2.68)$$

where

$$F(t) = \frac{t + (h - z)^2/(2c)}{t_0} \operatorname{erfc}[(h - z)/\sqrt{4c_v t}] - \frac{(h - z)\sqrt{t}}{t_0\sqrt{\pi c_v}} \exp[-(h - z)^2/2c_v t]. \quad (2.69)$$

Limiting behaviour

If $t_0 \rightarrow 0$ the first part, equation (2.65), never applies, and in the second part, equation (2.66), one may write

$$1 - \exp[(2k - 1)^2 \frac{\pi^2}{4} \frac{c_v t_0}{h^2}] = -(2k - 1)^2 \frac{\pi^2}{4} \frac{c_v t_0}{h^2}. \quad (2.70)$$

The solution then reduces to

$$t_0 \rightarrow 0 : \frac{p}{p_0} = \frac{4}{\pi} \sum_{k=1}^{\infty} \frac{(-1)^{k-1}}{2k - 1} \cos[(2k - 1) \frac{\pi z}{2h}] \exp[-(2k - 1)^2 \frac{\pi^2}{4} \frac{c_v t}{h^2}]. \quad (2.71)$$

This is precisely the solution of the previous problem, see equation (2.26). Thus the second problem is a proper generalization of the first problem.

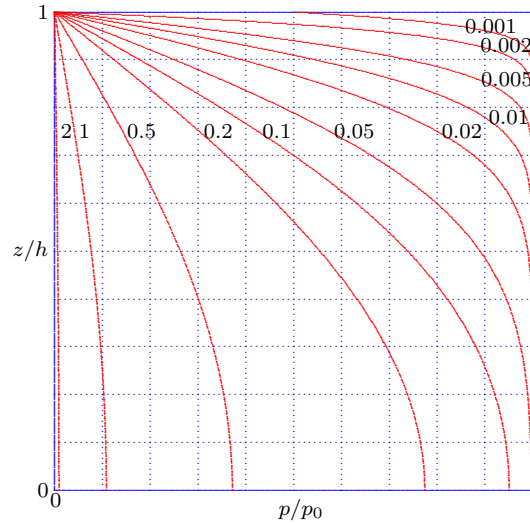

Figure 2.6: Gradual drainage : Pore pressure as a function of z/h and ct/h^2 .

For the computation of numerical values the solution of the modified problem has been used to develop a computer program. Figure 2.6 shows the pore pressure p/p_0 as a function of the two basic parameters z/h and $c_v t/h^2$, with $t_0 = 0.002$. It can be seen from the figure that at time $t = 0.001$ the pore pressure at the top is still one half of the initial value. As could be expected, there is hardly any difference with the classical solution shown in Figure 2.3 for values of time large compared to t_0 .

2.3 Terzaghi and Mixture theory

In this section Terzaghi's equations of the theory of consolidation are derived from the theory of mixtures. The two theories will appear to be in complete agreement for the classical case of one-dimensional consolidation of a soil with incompressible constituents (particles and water).

Since the development of the equations describing the process of consolidation of soft soils in the 1920's by Karl Terzaghi, many alternative methods of deriving and describing this process have been developed, under various names, such as mixture theory or porous media theory (Bowen, 1980, 1982; Coussy, 1995, 2004; De Boer, 1990; Morland *et al.*, 2004). These modern methods, which were anticipated by Fillunger (1936),

are based upon general and fundamental physical principles from the fields of continuum mechanics and thermodynamics, especially conservation equations of mass and momentum, and sometimes thermodynamic quantities. Furthermore, modern theories are not restricted to incompressible fluids and incompressible solid particles. As can be expected this does not make the equations easier to understand or to apply, especially compared to the wide range of applications of the generalized Terzaghi equations (Biot, 1941). The advantage of modern theories is often claimed to be the more rigorous character of the equations. It has even been stated that “Terzaghi’s derivation of the partial differential equation for describing the consolidation problem is not based upon the principles of mechanics” (De Boer, 1990, p. 455). In this paper it will be attempted to derive Terzaghi’s equations from the principles of mixture theory, for the simplest possible case of small deformations of a soil consisting of incompressible particles, containing an incompressible fluid in its pores. It will be demonstrated that there is indeed an inconsistency in one version of Terzaghi’s equations. But the original presentation of the theory is in complete agreement with mixture theory. The partly intuitive derivations of Terzaghi seem to indicate a deeper understanding of the principles of mechanics than is sometimes acknowledged.

2.3.1 The theory of one-dimensional consolidation

In this section the theory of consolidation will be presented for the classical one-dimensional case, using the approach from the theory of mixtures (Bowen, 1980, 1982). For reasons of simplicity the solids and the fluid will both be considered as incompressible, so that the only source of deformation is a rearrangement of the particle structure. Also, the analysis will be restricted to the simplest case of infinitesimally small deformations, and a linear constitutive relation.

In the theory of mixtures each component of the mixture is supposed to fill the entire volume, with partial coefficients indicating the various fractions. Saturated soils can be considered as a mixture of two components: a solid component representing the particles and a fluid component representing the water. The volumetric fractions of the two components are indicated by $1 - n$ for the solids and n for the fluid, where n is usually denoted as the *porosity*.

The first set of basic equations consists of the equations of conservation of mass. These are, for the two components,

$$\frac{\partial[(1 - n)\rho_s]}{\partial t} + \frac{\partial[(1 - n)\rho_s v_s]}{\partial z} = 0, \quad (2.72)$$

$$\frac{\partial(n\rho_f)}{\partial t} + \frac{\partial(n\rho_f v_f)}{\partial z} = 0, \quad (2.73)$$

where ρ_s and ρ_f are the densities of the solid and the fluid components, v_s and v_f are the (average) velocities of the solid and fluid molecules, and z is the spatial coordinate, positive in upward direction.

If it is assumed that the two components are incompressible, the two densities ρ_f and ρ_s are constant. The two equations (2.72) and (2.73) then reduce to

$$-\frac{\partial n}{\partial t} + \frac{\partial[(1 - n)v_s]}{\partial z} = 0, \quad (2.74)$$

$$\frac{\partial n}{\partial t} + \frac{\partial(nv_f)}{\partial z} = 0. \quad (2.75)$$

These equations can be considered as the equations of conservation of volume of the two components, which is perfectly valid if the components are incompressible. Addition of these two equations gives

$$\frac{\partial v_s}{\partial z} = -\frac{\partial[n(v_f - v_s)]}{\partial z}. \quad (2.76)$$

The quantity on the left hand side is the time derivative of the volume change $\partial\varepsilon_{\text{vol}}$ or, in this one-dimensional case the vertical strain rate $\partial\varepsilon/\partial t$. And the quantity $n(v_f - v_s)$ can be identified with the discharge through a unit total area (the *specific discharge*) q . It now seems trivial that this quantity, which was introduced by Darcy, must be expressed formally by the relative velocity of the fluid with respect to the solids, but the first to mention this explicitly was Gersevanov (1934). It follows that this basic equation can also be written as

$$\frac{\partial\varepsilon}{\partial t} = -\frac{\partial q}{\partial z}. \quad (2.77)$$

Because $\varepsilon = \Delta V/V$, where $V = V_s + V_p$, and the volume of the incompressible solids V_s is constant, it can be shown that

$$\frac{\partial \varepsilon}{\partial t} = \frac{1}{1+e} \frac{\partial e}{\partial t} = (1-n) \frac{\partial n}{\partial t}, \quad (2.78)$$

where e is the void ratio, $e = V_p/V_s$.

In the form (2.77), or an equivalent form using the void ratio e or the porosity n , the basic equation of volume change can be found in many publications from soil mechanics (Terzaghi, 1925; Terzaghi & Fröhlich, 1936; Scott, 1963; Harr, 1966; Lambe & Whitman, 1969; Verruijt, 1969; Craig, 1997; etc.), sometimes with an additional term representing the compressibility of the fluid. The equation is often simply presented as an almost self evident expression of the deformation of saturated soils, in which the only possibility of a volume change is the expulsion of pore fluid. It may be noted that in his first publications Terzaghi expressed his equations using a reduced (material) coordinate, and using the void ratio e as the variable describing the volume change. This is perhaps somewhat complicated, but it can be shown that his results are in complete agreement with equation (2.77). Unfortunately, in a later publication (Terzaghi, 1943) the left hand side of equation (2.77) was expressed as $\partial n/\partial t$. This differs from the correct expression $\partial \varepsilon/\partial t$ by a factor $1-n$, see equation (2.78), which results in an incorrect expression for the final consolidation coefficient. Because this coefficient is usually determined by comparison of laboratory measurements with theoretical results, the mistake is of little consequence in engineering practice. Also, in soil mechanics literature (e.g. Scott, 1963; Harr, 1966; Lambe & Whitman, 1969; Craig, 1997) the mistake has largely been ignored, even while referring to Terzaghi's 1943 book as a basic original source, and giving the correct expression (2.77) or an equivalent form. Apparently, his successors have forgiven Terzaghi this mistake. But it remains unfortunate, of course.

The second set of basic equations consists of the equations of conservation of linear momentum. These are, for the two components,

$$(1-n)\rho_s \frac{\partial v_s}{\partial t} = -\frac{\partial[(1-n)\sigma_s]}{\partial z} - (1-n)\rho_s g + F_{sf}, \quad (2.79)$$

$$n\rho_f \frac{\partial v_f}{\partial t} = -\frac{\partial(np)}{\partial z} - n\rho_f g - F_{sf}, \quad (2.80)$$

where σ_s is the partial stress in the solids, p is the fluid pressure (both considered positive for compression), g is the gravity constant, and F_{sf} is the interaction force between solids and fluid, per unit volume. In the quasi-static case of classical consolidation, as considered here, the inertial terms in the right hand sides of equations (2.79) and (2.80) can be disregarded.

A third set of equations consists of the constitutive equations, which should describe the interaction force between solids and fluid, and the deformation of the soil skeleton. This interaction force is postulated to consist of two parts,

$$F_{sf} = \frac{n^2\mu(v_f - v_s)}{\kappa} - p \frac{\partial n}{\partial z} = \frac{n\mu q}{\kappa} - p \frac{\partial n}{\partial z}, \quad (2.81)$$

where μ is the fluid viscosity, and κ is the (intrinsic) permeability of the porous medium. The first term on the right hand side represents the viscous friction of the moving fluid through the porous medium, and the second part, which is ignored in most applications of mixture theory to the mechanics of porous media, represents the interaction due to the change of shape of the pore space. This term corresponds to the interaction between the fluid and the container in a system of a fluid-filled container, as first considered by Stevin (1586), see Dijksterhuis (1955). This interaction is also responsible for the *hydrostatic paradox* (Sears, Zemansky & Young, 1976), see Figure 2.7. It can be demonstrated in the classroom that the force on the bottom in the three vessels is equal, if their bottom area is equal, and yet the weight of the second vessel is definitely greater than that of the first vessel. The additional weight of the water is transmitted from the fluid to the sloping sides of the vessel, of course.

That the second term in equation (2.81) is really necessary can be seen by substitution into equation (2.80) for the quasi-static case. This then gives

$$q = -\frac{k}{\rho_f g} \left(\frac{\partial p}{\partial z} + \rho_f g \right), \quad (2.82)$$

where $k = \kappa\rho_f g/\mu$ is the hydraulic conductivity. Equation (2.82) is Darcy's law, the validity of which is not believed to be in question. Omitting the second term in equation (2.81) would lead to a different form of Darcy's law, which then is also in disagreement with hydrostatics in the absence of flow.

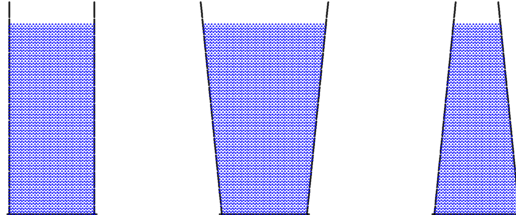

Figure 2.7: Stevin's hydrostatic paradox

For a description of the deformation of the soil skeleton it is most convenient to add equations (2.79) and (2.80). If the inertia terms are disregarded this gives

$$\frac{\partial \sigma}{\partial z} + \rho g = 0, \quad (2.83)$$

where $\sigma = (1 - n)\sigma_s + np$, the total stress, and $\rho = (1 - n)\rho_s + n\rho_f$, the total density of the soil.

Because the solid particles have been assumed to be incompressible, the only remaining mechanism of deformation of the soil is a rearrangement of the solid particles, by sliding and rolling over each other. This must be governed by the forces transmitted in the contact points. And because in case of a pressure p in the fluid phase leads to an equal stress in the solids there are no forces in the contact points, and therefore no deformations, it follows that a good measure for the forces in the contact points is the effective stress σ' , defined as

$$\sigma' = \sigma - p. \quad (2.84)$$

In case of a material with compressible solid particles this needs some adjustment by a reduction of the pore pressure, using Biot's coefficient, see equation (1.14), see also Skempton (1960).

The constitutive equation of the soil skeleton must be formulated in terms of this effective stress. In the linear theory this can be assumed to be

$$\frac{\partial \varepsilon}{\partial t} = -m_v \frac{\partial \sigma'}{\partial t}, \quad (2.85)$$

where ε is the vertical strain, and m_v is the compressibility of the soil.

If the total stress σ remains constant during the consolidation process, it follows that

$$\frac{\partial \varepsilon}{\partial t} = -m_v \frac{\partial p}{\partial t}, \quad (2.86)$$

and then it follows from equations (2.77), (2.82) and (2.86) that

$$m_v \frac{\partial p}{\partial t} = \frac{\partial}{\partial z} \left[\frac{k}{\rho_f g} \left(\frac{\partial p}{\partial z} + \rho_f g \right) \right], \quad (2.87)$$

which is precisely the form of Terzaghi's differential equation, for a non-homogeneous material.

Various generalizations of Terzaghi's theory have been made, for instance to three-dimensional consolidation for a material with a compressible pore fluid and compressible solid particles, following the basic work of Biot (1941). For large strains the basis for the generalization of Terzaghi's theory has been given by Gibson, England & Hussey, (1967).

2.3.2 Conclusion

It has been shown that Terzaghi's theory of consolidation, and its generalizations to non-homogeneous materials, are in complete agreement with the fundamental approach to consolidation provided by the theory of mixtures, for the case of small strains. This requires the inclusion in the expression for the interaction between fluid and solids of a term accounting for the transfer of force from the fluid to the solid if the porosity is not constant, even if there is no flow. This term, which is often ignored, is in agreement with the elementary physical principles of hydrostatics.

2.4 Periodic load

This section discusses a variant of Terzaghi's consolidation problem: a confined soil sample, subjected to a periodic load at its upper surface. The lower boundary is impermeable, and the upper boundary is fully drained, see Figure 2.8. As in Terzaghi's original work the soil particles are assumed to be incompressible,

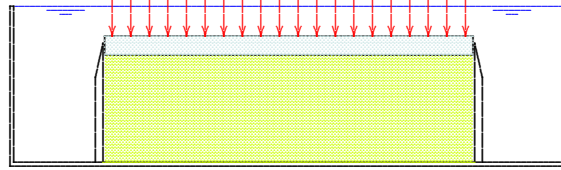

Figure 2.8: One-dimensional consolidation with periodic load.

so that the only mechanisms of deformation are the compression of the soil due to a rearrangement of the particle structure, and compression of the pore fluid.

The problem and its solution can be obtained from the analogous heat conduction problem considered by Carslaw & Jaeger (1959). The problem has been considered and solved as a consolidation problem by Zienkiewicz, Chang & Bettess (1980). The problem is also a simplified version of a problem of poroelastodynamics considered by De Boer (2000, section 5.9.b) and Verruijt (2010, section 5.4.1).

2.4.1 Statement of the problem

The basic differential equation is, see equation (2.7),

$$\frac{\partial p}{\partial t} = \frac{\alpha m_v}{S + \alpha^2 m_v} \frac{\partial \sigma_{zz}}{\partial t} + c_v \frac{\partial^2 p}{\partial z^2}, \quad (2.88)$$

where p is the pore pressure, σ_{zz} is the vertical total stress on the soil, α is Biot's coefficient, m_v is the compressibility of the (elastic) soil, S is the storativity, and c_v is the consolidation coefficient of the porous medium

$$c_v = \frac{k}{\gamma_f (S + \alpha^2 m_v)}. \quad (2.89)$$

It is assumed that the vertical load is

$$\sigma_{zz} = q \sin^2 \frac{\pi t}{t_0} = \frac{1}{2} - \frac{1}{2} \cos \frac{2\pi t}{t_0}. \quad (2.90)$$

Equation (2.88) now becomes

$$\frac{\partial p}{\partial t} = \frac{\pi q'}{t_0} \sin \frac{2\pi t}{t_0} + c_v \frac{\partial^2 p}{\partial z^2}, \quad (2.91)$$

where

$$q' = \frac{\alpha m_v}{S + \alpha^2 m_v} q. \quad (2.92)$$

The boundary conditions are supposed to be

$$z = 0 : \frac{\partial p}{\partial z} = 0, \quad (2.93)$$

$$z = h : p = 0, \quad (2.94)$$

and it is assumed that the initial condition is

$$t = 0 : p = 0. \quad (2.95)$$

2.4.2 Steady state solution

As an introduction to the full problem it may be convenient to first consider the steady state, obtained for very large values of time, and ignoring the initial condition. It is assumed that this steady state solution can be written as

$$p_\infty = f(z) \sin \frac{2\pi t}{t_0} + g(z) \cos \frac{2\pi t}{t_0}. \quad (2.96)$$

Substitution into the differential equation (2.91) leads to the following two equations

$$\frac{d^2 f}{dz^2} = -2a^2 g - a^2 q', \quad (2.97)$$

$$\frac{d^2 g}{dz^2} = 2a^2 f, \quad (2.98)$$

where

$$a^2 = \frac{\pi}{c_v t_0}. \quad (2.99)$$

The general solution of the equations (2.97) and (2.98) is

$$f = A \exp(az) \cos(az) + B \exp(az) \sin(az) + C \exp(-az) \cos(az) + D \exp(-az) \sin(az), \quad (2.100)$$

$$g = A \exp(az) \sin(az) - B \exp(az) \cos(az) - C \exp(-az) \sin(az) + D \exp(-az) \cos(az) - \frac{1}{2} q'. \quad (2.101)$$

The boundary condition (2.93) requires that

$$z = 0 : \frac{df}{dz} = 0, \quad \frac{dg}{dz} = 0. \quad (2.102)$$

This gives :

$$C = A, \quad D = -B. \quad (2.103)$$

Equations (2.100) and (2.101) then reduce to

$$f = 2A \cosh(az) \cos(az) + 2B \sinh(az) \sin(az), \quad (2.104)$$

$$g = 2A \sinh(az) \sin(az) - 2B \cosh(az) \cos(az) - \frac{1}{2} q'. \quad (2.105)$$

It can easily be verified that the expressions (2.104) and (2.105) satisfy the differential equations (2.97) and (2.98), and the boundary conditions (2.102).

The constants A and B can be determined using the boundary condition at $z = h$, see equation (2.94). This boundary condition will be satisfied if

$$z = h : f = 0, \quad g = 0. \quad (2.106)$$

With equations (2.104) and (2.105) this gives

$$2A \cosh(ah) \cos(ah) + 2B \sinh(ah) \sin(ah) = 0, \quad (2.107)$$

$$2A \sinh(ah) \sin(ah) - 2B \cosh(ah) \cos(ah) = \frac{1}{2} q'. \quad (2.108)$$

It follows from these equations that

$$\frac{2A}{q'} = \frac{\sinh(ah) \sin(ah)}{\cosh(2ah) + \cos(2ah)}, \quad (2.109)$$

$$\frac{2B}{q'} = -\frac{\cosh(ah) \cos(ah)}{\cosh(2ah) + \cos(2ah)}, \quad (2.110)$$

where use has been made of the identity

$$2 \cosh^2(ah) \cos^2(ah) + 2 \sinh^2(ah) \sin^2(ah) = \cosh(2ah) + \cos(2ah), \quad (2.111)$$

which can be derived from the properties of the circular and hyperbolic functions.

The parameter ah in these expressions is, with equation (2.99),

$$ah = h\sqrt{\pi/(c_v t_0)}. \quad (2.112)$$

This is the inverse of the square root of the period t_0 of the fluctuation of the load. If ah is small, this period is so large that consolidation is practically completed in a full period, and if ah is large, the fluctuation is so fast that consolidation remains in its early phases.

Substitution of equations (2.109) and (2.110) into equations (2.104) and (2.105) now gives

$$\frac{f}{q'} = \frac{\sinh(ah) \sin(ah) \cosh(az) \cos(az) - \cosh(ah) \cos(ah) \sinh(az) \sin(az)}{\cosh(2ah) + \cos(2ah)}, \quad (2.113)$$

$$\frac{g}{q'} = \frac{\sinh(ah) \sin(ah) \sinh(az) \sin(az) + \cosh(ah) \cos(ah) \cosh(az) \cos(az)}{\cosh(2ah) + \cos(2ah)} - \frac{1}{2}. \quad (2.114)$$

The values of the pore pressure can be calculated using equation (2.96)

$$p_\infty = f(z) \sin \frac{2\pi t}{t_0} + g(z) \cos \frac{2\pi t}{t_0}. \quad (2.115)$$

This can also be written as

$$p_\infty = p_0 \sin\left(\frac{2\pi t}{t_0} + \phi\right), \quad (2.116)$$

where p_0 and ϕ are the amplitude and the phase angle of the pore pressure variations,

$$p_0 = \sqrt{f^2 + g^2}, \quad \tan \phi = g/f. \quad (2.117)$$

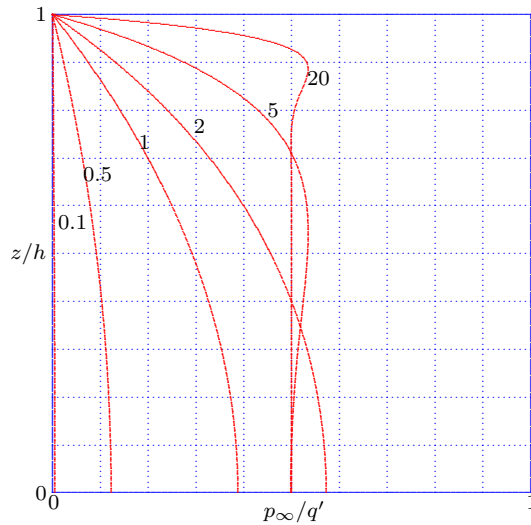

Figure 2.9: Amplitude of pore pressure as a function of z/h and ah .

Figure 2.9 shows the amplitude of the pore pressure as a function of z/h , for a number of values of the parameter ah .

2.4.3 An alternative derivation of the steady state solution

As an alternative for the solution method used in the previous section one may note that the given term in the differential equation (2.91) can be written as

$$\frac{\pi q'}{t_0} \sin \frac{2\pi t}{t_0} = \Im\left\{\frac{\pi q'}{t_0} \exp \frac{2\pi i t}{t_0}\right\}, \quad (2.118)$$

which suggests to express the pore pressure in a similar way as

$$p_\infty = \Im\left\{F(z) \exp\left(\frac{2\pi it}{t_0}\right)\right\}. \quad (2.119)$$

The differential equation (2.91) then gives, if taking the imaginary part only is postponed to a later stage,

$$\frac{d^2 F}{dz^2} = 2ia^2 F - a^2 q', \quad (2.120)$$

where, as before,

$$a^2 = \frac{\pi}{c_v t_0}. \quad (2.121)$$

The general solution of equation (2.120) is

$$F = A \exp[(1+i)az] + B \exp[-(1+i)az] - \frac{1}{2}iq', \quad (2.122)$$

with the first derivative

$$\frac{dF}{dz} = A(1+i)a \exp[(1+i)az] - B(1+i) \exp[-(1+i)az]. \quad (2.123)$$

The boundary condition

$$z = 0 : \frac{dF}{dz} = 0, \quad (2.124)$$

now gives

$$A = B, \quad (2.125)$$

so that the solution (2.122) reduces to

$$F = 2A \cosh[(1+i)az] - \frac{1}{2}iq'. \quad (2.126)$$

From the second boundary condition,

$$z = h : F = 0, \quad (2.127)$$

it follows that

$$2A \cosh[(1+i)ah] = \frac{1}{2}iq'. \quad (2.128)$$

The final solution for F is

$$F = \frac{1}{2}iq' \left(\frac{\cosh[(1+i)az]}{\cosh[(1+i)ah]} - 1 \right). \quad (2.129)$$

Substitution of this result into equation (2.119) gives as an alternative solution for the pore pressure

$$\frac{p_\infty}{q'} = \Im\left\{\frac{1}{2}i \left(\frac{\cosh[(1+i)az]}{\cosh[(1+i)ah]} - 1 \right) \exp \frac{2\pi it}{t_0}\right\}. \quad (2.130)$$

It follows that

$$\frac{p_\infty}{q'} = -\frac{1}{2}\Im\left\{\frac{\cosh[(1+i)az]}{\cosh[(1+i)ah]} - 1\right\} \sin\left(\frac{2\pi t}{t_0}\right) + \frac{1}{2}\Re\left\{\frac{\cosh[(1+i)az]}{\cosh[(1+i)ah]} - 1\right\} \cos\left(\frac{2\pi t}{t_0}\right), \quad (2.131)$$

so that, in the form of equation (2.96),

$$\frac{f}{q'} = -\frac{1}{2}\Im\left\{\frac{\cosh[(1+i)az]}{\cosh[(1+i)ah]} - 1\right\}, \quad (2.132)$$

$$\frac{g}{q'} = \frac{1}{2}\Re\left\{\frac{\cosh[(1+i)az]}{\cosh[(1+i)ah]} - 1\right\}. \quad (2.133)$$

These expressions are in agreement with the results (2.113) and (2.114) obtained earlier, as illustrated in Figure 2.10, which has been constructed using the alternative solution.

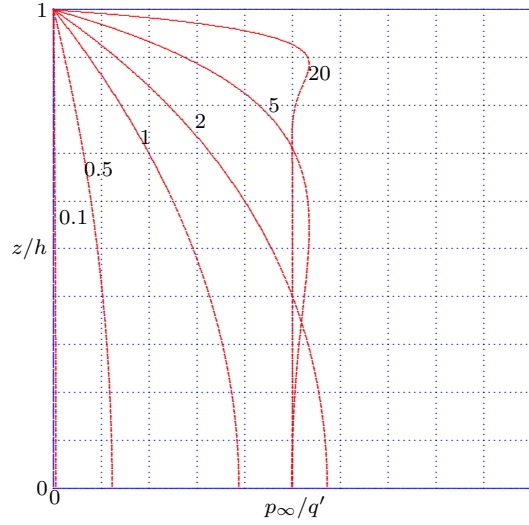
Figure 2.10: Amplitude of pore pressure as a function of z/h and ah .

2.4.4 Complete solution

The complete problem, including the consolidation process, can probably best be solved using the Laplace transform method (Carslaw & Jaeger, 1948, 1959; Churchill, 1972),

$$\bar{p} = \int_0^{\infty} p \exp(-st) dt. \quad (2.134)$$

The Laplace transformation of the differential equation (2.91) can be determined using the standard transformation

$$\int_0^{\infty} \sin(at) \exp(st) dt = \frac{a}{s^2 + a^2}. \quad (2.135)$$

This gives

$$\frac{d^2 \bar{p}}{dz^2} = \frac{s}{c_v} \bar{p} - \frac{2\pi^2 q' / t_0^2}{c_v (s^2 + 4\pi^2 / t_0^2)}. \quad (2.136)$$

The general solution of this differential equation is

$$\bar{p} = A \exp(z\sqrt{s/c_v}) + B \exp(-z\sqrt{s/c_v}) + \frac{2\pi^2 q' / t_0^2}{s(s^2 + 4\pi^2 / t_0^2)}. \quad (2.137)$$

The coefficients A and B can be determined using the boundary conditions (2.93) and (2.94). This gives

$$\bar{p} = \frac{2\pi^2 q' / t_0^2}{s(s^2 + 4\pi^2 / t_0^2)} - \frac{2\pi^2 q' / t_0^2}{s(s^2 + 4\pi^2 / t_0^2)} \frac{\cosh(z\sqrt{s/c_v})}{\cosh(h\sqrt{s/c_v})}. \quad (2.138)$$

Inverse Laplace transformation gives

$$p = p_1 + p_2, \quad (2.139)$$

where the two parts represent the inverse Laplace transforms of the two expressions in equation (2.138).

The first part of the solution is

$$p_1 = \frac{1}{2} q' \left[1 - \cos \frac{2\pi t}{t_0} \right], \quad (2.140)$$

which represents the part of the problem due to the load only, disregarding the consolidation, as described by the first term in the right hand side of equation (2.91),

$$\frac{\partial p}{\partial t} = \frac{\pi q'}{t_0} \sin \frac{2\pi t}{t_0}. \quad (2.141)$$

The second term in the Laplace transform of the solution, equation (2.138), can be written as

$$\bar{p}_2 = \frac{P(s)}{Q(s)}, \quad (2.142)$$

where

$$P(s) = -2(\pi^2 q' / t_0^2) \cosh(z\sqrt{s/c_v}), \quad (2.143)$$

$$Q(s) = s(s^2 + 4\pi^2 / t_0^2) \cosh(h\sqrt{s/c_v}). \quad (2.144)$$

Using Heaviside's inversion theorem (Churchill, 1972) the inverse Laplace transform can be written as

$$p_2 = \sum_{i=0}^{\infty} \frac{P(s_i)}{Q'(s_i)} \exp(s_i t), \quad (2.145)$$

where the values s_i are the zeroes of the function $Q(s)$. The first derivative of this function is

$$Q'(s) = (3s^2 + 4\pi^2 / t_0^2) \cosh(h\sqrt{s/c_v}) + \frac{1}{2}(s^2 + 4\pi^2 / t_0^2)(h\sqrt{s/c_v}) \sinh(h\sqrt{s/c_v}). \quad (2.146)$$

The zeroes of the function $Q(s)$ are

$$s = 0, \quad s = s_a = 2i\pi / t_0, \quad s = s_b = -2i\pi / t_0, \quad (2.147)$$

and the zeroes of the function $\cosh(h\sqrt{s/c_v})$, which can be assumed to be the zeroes of the function $\cos(ih\sqrt{s/c_v})$. These are

$$ih\sqrt{s/c_v} = (1 + 2k)\frac{\pi}{2}, \quad k = 0, 1, 2, \dots \quad (2.148)$$

This leads to the following values of s

$$s = s_k = -(1 + 2k)^2 \frac{\pi^2 c_v}{4h^2}, \quad k = 0, 1, 2, \dots \quad (2.149)$$

The contributions of the various singularities will be considered successively.

The pole $s = 0$

For the pole $s = 0$ the values of $P(s)$ and $Q'(s)$ are

$$P(0) = -2\pi^2 q' / t_0^2, \quad (2.150)$$

$$Q'(0) = 4\pi^2 / t_0^2. \quad (2.151)$$

This gives

$$p_0 = -\frac{1}{2}q'. \quad (2.152)$$

The pole $s = s_a = 2i\pi / t_0$

For the pole $s = s_a$ the values of $P(s)$ and $Q'(s)$ are

$$P(a) = -2(\pi^2 q' / t_0^2) \cosh[(1 + i)az], \quad (2.153)$$

$$Q'(a) = -8(\pi^2 / t_0^2) \cosh[(1 + i)ah], \quad (2.154)$$

where the parameter $a = \sqrt{\pi/c_v t_0}$, as defined in equation (2.99).

It follows that

$$p_a = \frac{1}{4}q' \frac{\cosh[(1 + i)az]}{\cosh[(1 + i)ah]} \exp(2i\pi t / t_0). \quad (2.155)$$

The pole $s = s_b = -2i\pi/t_0$

For the pole $s = s_b$ the values of $P(s)$ and $Q'(s)$ are

$$P(b) = -2(\pi^2 q'/t_0^2) \cosh[(1-i)az], \quad (2.156)$$

$$Q'(b) = -8(\pi^2/t_0^2) \cosh[(1-i)ah]. \quad (2.157)$$

This gives

$$p_b = \frac{1}{4}q' \frac{\cosh[(1-i)az]}{\cosh[(1-i)ah]} \exp(-2i\pi t/t_0). \quad (2.158)$$

The values of p_a and p_b are each others complex conjugate. It follows that their sum is

$$p_a + p_b = \frac{1}{2}q' \Re \left\{ \frac{\cosh[(1+i)az]}{\cosh[(1+i)ah]} \right\} \cos(2\pi t/t_0) - \frac{1}{2}q' \Im \left\{ \frac{\cosh[(1+i)az]}{\cosh[(1+i)ah]} \right\} \sin(2\pi t/t_0). \quad (2.159)$$

The steady state solution

The poles $s = s_k$ all have a negative real part, and therefore will give rise to terms that tend towards zero for $t \rightarrow \infty$. The other terms together represent the steady state solution,

$$p_\infty = p_1 + p_0 + p_a + p_b. \quad (2.160)$$

With equations (2.140), (2.152) and (2.159) this gives

$$\frac{p_\infty}{q'} = -\frac{1}{2}\Im \left\{ \frac{\cosh[(1+i)az]}{\cosh[(1+i)ah]} - 1 \right\} \sin(2\pi t/t_0) + \frac{1}{2}\Re \left\{ \frac{\cosh[(1+i)az]}{\cosh[(1+i)ah]} - 1 \right\} \cos(2\pi t/t_0). \quad (2.161)$$

This is in agreement with the steady state solution given in equations (2.131).

The poles $s = s_k$

The remaining terms in the solution represent the consolidation process. The poles $s = s_k$ indicate that for these values the function $\cosh(h\sqrt{s/c_v}) = 0$. This is the case for the imaginary values $h\sqrt{s/c_v} = i(1+2k)\pi/2$. For these values $\cosh(h\sqrt{s/c}) = \cosh[i(1+2k)\pi/2] = \cos[(1+2k)\pi/2]$, which is indeed zero for all integer values of k .

In this case

$$P(s_k) = -2(\pi^2 q'/t_0^2) \cosh(z\sqrt{s/c_v}) = -2(\pi^2 q'/t_0^2) \cos[(1+2k)\frac{\pi z}{2h}]. \quad (2.162)$$

Furthermore

$$Q'(s_k) = \frac{1}{2}[(1+2k)^4 \frac{\pi^4 c_v^2}{16h^4} + \frac{4\pi^2}{t_0^2}] i(1+2k) \frac{\pi}{2} \sinh[i(1+2k)\frac{\pi}{2}], \quad (2.163)$$

or, because $\sinh[i(1+2k)\pi/2] = i \sin[(1+2k)\pi/2] = i(-1)^k$,

$$Q'(s_k) = -\frac{\pi^3}{t_0^2} (1+2k)(-1)^k \left[1 + \frac{(1+2k)^4 \pi^2 c_v^2 t_0^2}{64h^4} \right] \quad (2.164)$$

It now follows that the remaining terms in the solution are

$$\frac{p_c}{q'} = \frac{2}{\pi} \sum_{k=0}^{\infty} \frac{(-1)^k \cos[(1+2k)\pi z/2h]}{1+2k} \frac{1}{1 + (1+2k)^4 \pi^2 c_v^2 t_0^2 / 64h^4} \exp[-(1+2k)^2 \pi^2 c_v t / 4h^2]. \quad (2.165)$$

It can easily be seen that each of the terms in this series satisfies the boundary conditions

$$z = 0 : \frac{\partial p}{\partial z} = 0, \quad (2.166)$$

and

$$z = h : p = 0. \quad (2.167)$$

That the initial condition $t = 0 : p = 0$ is also satisfied can best be verified numerically.

2.4.5 Graphics

The complete solution of the problem is the sum of equations (2.161) and (2.165),

$$\begin{aligned} \frac{p}{q'} = & -\frac{1}{2}\Im\left\{\frac{\cosh[(1+i)az]}{\cosh[(1+i)ah]} - 1\right\} \sin(2\pi t/t_0) + \frac{1}{2}\Re\left\{\frac{\cosh[(1+i)az]}{\cosh[(1+i)ah]} - 1\right\} \cos(2\pi t/t_0) \\ & + \frac{2}{\pi} \sum_{k=0}^{\infty} \frac{(-1)^k \cos[(1+2k)\pi z/2h]}{1+2k} \frac{1}{1+(1+2k)^4\pi^2 t_0^2/64t_c^2} \exp[-(1+2k)^2\pi^2 t/4t_c], \end{aligned} \quad (2.168)$$

where

$$t_c = h^2/c_v, \quad (2.169)$$

the consolidation time.

The basic parameters in the solution are z/h , t/t_0 and t/t_c . The parameter a is related to these parameters by equation (2.99). It follows that

$$(ah)^2 = \pi \frac{t_c}{t_0} = \pi \frac{t/t_0}{t/t_c}. \quad (2.170)$$

The figures 2.11, 2.12 and 2.13 show the pore pressure as a function of z/h , for the three values $t_c/t_0 = 0.1$, $t_c/t_0 = 1$ and $t_c/t_0 = 10$, and for values of time ranging from $t = 0$ to $t = \frac{1}{2}t_0$. In the first case, with $t_c/t_0 = 0.1$, the consolidation time is so small that the pore pressures can hardly develop. In the third case, with $t_c/t_0 = 10$, the consolidation time is so large that the drainage occurs near the surface only.

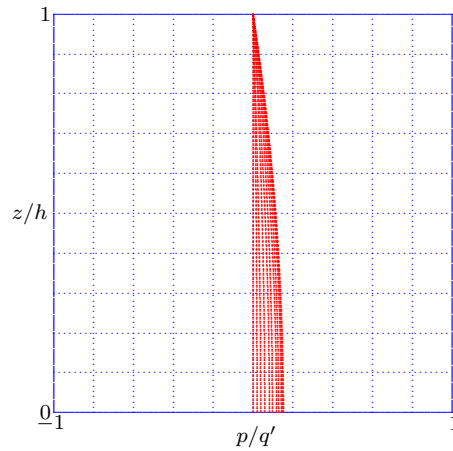

Figure 2.11: Pore pressure as a function of z/h ; $t_c/t_0 = 0.1$, $0 < t < \frac{1}{2}t_0$.

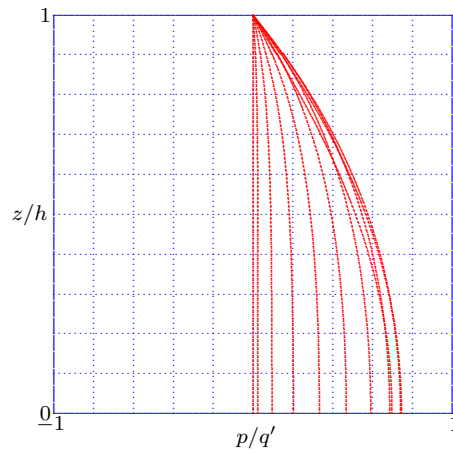

Figure 2.12: Pore pressure as a function of z/h ; $t_c/t_0 = 1$, $0 < t < \frac{1}{2}t_0$.

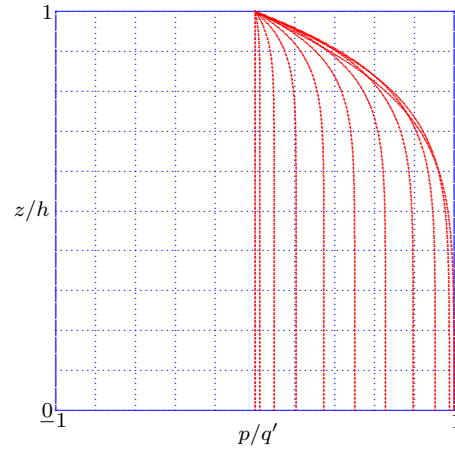

Figure 2.13: Pore pressure as a function of z/h ; $t_c/t_0 = 10$, $0 < t < \frac{1}{2}t_0$.

2.5 Two-layered soil

In this section the analytical solution of the problem of one-dimensional consolidation of a soil consisting of two layers with different properties is presented, and compared with results of a finite element analysis. The analytical method of solution is similar to the solution of a problem of heat conduction in a composite slab, as discussed by Carslaw & Jaeger (1959; p. 323). Two cases will be considered: one in which the lower boundary is impermeable, and the upper boundary is fully drained, and a second case in which both boundaries are fully drained. The finite element model is a simple one dimensional model, using linear variations of the pore pressure in each element (Verruijt, 1995). It is presented in section 2.6.

2.5.1 The first problem

The first problem to be considered is the consolidation of a soil consisting of two layers, see Figure 2.14. The properties of the two layers are their thicknesses h_1 and h_2 , permeabilities k_1 and k_2 , and compressibilities m_1 and m_2 . The boundary conditions for the first problem are that the lower boundary is rigid and impermeable, and that the upper boundary is fully drained and free to deform. The load is a step load, applied at time $t = 0$, resulting in a uniform pore pressure in the soil. The pore pressures will start to dissipate at time $t = 0$,

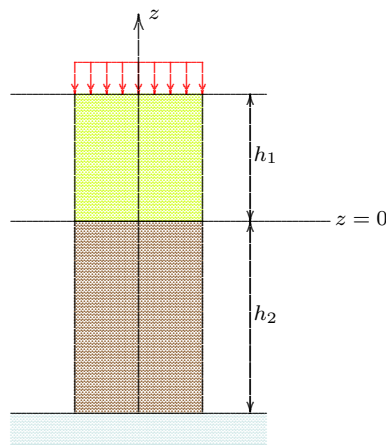

Figure 2.14: Soil consisting of two layers.

but at a different rate in the two layers, depending upon their consolidation coefficients, defined as

$$c_1 = \frac{k_1}{\gamma m_1}, \quad c_2 = \frac{k_2}{\gamma m_2}, \quad (2.171)$$

where γ is the unit weight of the pore fluid, which is supposed to be $\gamma = 10 \text{ kN/m}^3$.

It is the purpose of this section to determine the pore pressure distribution as a function of time t and the vertical coordinate z .

Basic equations

Following Carslaw & Jaeger (1959), it seems most simple to assume that the vertical coordinate $z = 0$ is located at the interface of the two layers, see Figure 2.14.

In the upper part of the soil the differential equation is

$$z > 0 : \frac{\partial p_1}{\partial t} = c_1 \frac{\partial^2 p_1}{\partial z^2}. \quad (2.172)$$

In the lower part the differential equation is

$$z < 0 : \frac{\partial p_2}{\partial t} = c_2 \frac{\partial^2 p_2}{\partial z^2}. \quad (2.173)$$

The boundary conditions at the interface are that the pressure and the specific discharge are continuous,

$$z = 0 : p_1 = p_2, \quad (2.174)$$

$$z = 0 : k_1 \frac{\partial p_1}{\partial z} = k_2 \frac{\partial p_2}{\partial z}. \quad (2.175)$$

The bottom of the soil is assumed to be impermeable, so that

$$z = -h_2 : \frac{\partial p_2}{\partial z} = 0. \quad (2.176)$$

At the top of the soil full drainage is assumed,

$$z = h_1 : p_1 = 0. \quad (2.177)$$

The initial condition is that at time $t = 0$ the pressure throughout the soil is given, determined by the load,

$$t = 0 : p = p_0. \quad (2.178)$$

Solution

The problem can be solved using the Laplace transform method, see e.g. Churchill (1972). The Laplace transform of the pressure is defined as

$$\bar{p} = \int_0^\infty p \exp(-st) dt, \quad (2.179)$$

where s is the transformation parameter.

The transformed differential equation for the upper part is

$$z > 0 : s\bar{p}_1 - p_0 = c_1 \frac{d^2 \bar{p}_1}{dz^2}, \quad (2.180)$$

with the general solution

$$\bar{p}_1 = \frac{p_0}{s} + A \sinh(q_1 z) + B \cosh(q_1 z), \quad (2.181)$$

where q_1 is defined by

$$q_1^2 = s/c_1. \quad (2.182)$$

In the lower part the transformed differential equation is

$$z < 0 : s\bar{p}_2 - p_0 = c_2 \frac{d^2 \bar{p}_2}{dz^2}, \quad (2.183)$$

with the general solution

$$\bar{p}_2 = \frac{p_0}{s} + C \sinh(q_2 z) + D \cosh(q_2 z), \quad (2.184)$$

where q_2 is defined by

$$q_2^2 = s/c_2. \quad (2.185)$$

The four integration constants A , B , C and D can be determined from the conditions (2.174) – (2.177). This gives

$$A = -\frac{p_0}{s} \frac{\alpha \sinh(q_2 h_2)}{Q_1}, \quad (2.186)$$

$$B = -\frac{p_0}{s} \frac{\cosh(q_2 h_2)}{Q_1}, \quad (2.187)$$

$$C = -\frac{p_0}{s} \frac{\sinh(q_2 h_2)}{Q_1}, \quad (2.188)$$

$$D = -\frac{p_0}{s} \frac{\cosh(q_2 h_2)}{Q_1}, \quad (2.189)$$

where α is a constant defined by

$$\alpha = \frac{k_2 q_2}{k_1 q_1} = \frac{\sqrt{k_2 m_2}}{\sqrt{k_1 m_1}}, \quad (2.190)$$

and Q_1 is a function of s , defined as

$$Q_1 = \alpha \sinh(q_1 h_1) \sinh(q_2 h_2) + \cosh(q_1 h_1) \cosh(q_2 h_2). \quad (2.191)$$

The two solutions in the two regions now are, expressed as Laplace transforms,

$$z > 0 : \bar{p}_1 = \frac{p_0}{s} - \frac{p_0}{s} \frac{\alpha \sinh(q_2 h_2) \sinh(q_1 z) + \cosh(q_2 h_2) \cosh(q_1 z)}{\alpha \sinh(q_1 h_1) \sinh(q_2 h_2) + \cosh(q_1 h_1) \cosh(q_2 h_2)}, \quad (2.192)$$

$$z < 0 : \bar{p}_2 = \frac{p_0}{s} - \frac{p_0}{s} \frac{\sinh(q_2 h_2) \sinh(q_2 z) + \cosh(q_2 h_2) \cosh(q_2 z)}{\alpha \sinh(q_1 h_1) \sinh(q_2 h_2) + \cosh(q_1 h_1) \cosh(q_2 h_2)}. \quad (2.193)$$

It can easily be verified that these expressions satisfy the four boundary conditions (2.174) – (2.177), using the definition (2.190) of the constant α .

The inverse Laplace transforms can be obtained using the complex inversion integral, or Heaviside's inversion theorem (Churchill, 1972). This theorem enables the inverse Laplace transformation of a function of the form

$$\bar{f} = \frac{P(s)}{s Q(s)}, \quad (2.194)$$

where $Q(s)$ is a function with n zeroes of the first order $s = s_j$, $j = 1, 2, \dots, n$, all unequal to zero. The inverse Laplace transform is

$$f = \frac{P(0)}{Q(0)} + \sum_{j=1}^n \frac{P(s_j)}{s_j Q'(s_j)} \exp(-s_j t), \quad (2.195)$$

where $Q'(s)$ is the derivative of $Q(s)$,

$$Q'(s) = \frac{dQ}{ds}. \quad (2.196)$$

To apply this theorem the first step is to determine the zeroes of the function $Q_1(s)$. For this purpose this function is rewritten, using the definitions of q_1 and q_2 in equations (2.182) and (2.185), as

$$Q_1(s) = \alpha \sinh(\sqrt{st_1}) \sinh(\sqrt{st_2}) + \cosh(\sqrt{st_1}) \cosh(\sqrt{st_2}), \quad (2.197)$$

where

$$t_1 = h_1^2/c_1, \quad t_2 = h_2^2/c_2, \quad (2.198)$$

which are measures for the consolidation times of the two layers.

It is assumed that the zeroes of the expression (2.197) are all imaginary, with

$$\sqrt{st_2} = ix. \quad (2.199)$$

For these zeroes the expression (2.197) can be written as

$$Q_1 = -\alpha \sin(\beta x) \sin(x) + \cos(\beta x) \cos(x) = 0, \quad (2.200)$$

where

$$\beta = \sqrt{t_1/t_2}. \quad (2.201)$$

The basic functions in equation (2.200) are all periodic with a period of 2π or $2\pi/\beta$. This means that it is unlikely that there are zeroes of this equation closer together than $2\pi/1000$ or $2\pi/(1000 * \beta)$. Because for $x = 0$ the function $Q_1 = 1$, the first zero can be determined by increasing the value of x by small increments ε , for instance $\varepsilon = 0.001$, until an interval is found where the function changes sign. The zero between these two points can then be determined by successively bisecting this interval, until the value in the mid-point is sufficiently small. This is the first zero, x_1 . The next zero can then be found in a similar way, starting from a point just to the right of the first zero. The number of zeroes to be determined can be chosen as $n = 20$ or $n = 100$, depending upon the desired accuracy.

Once the zeroes of the function $Q_1(s)$ have been determined, the next step is to evaluate the expressions in equation (2.195). The function $sQ_1'(s)$ can be evaluated by differentiation of the expression (2.197). This gives

$$sQ_1'(s) = \frac{1}{2} \{ (\alpha\sqrt{st_1} + \sqrt{st_2}) \cosh(\sqrt{st_1}) \sinh(\sqrt{st_2}) + (\alpha\sqrt{st_2} + \sqrt{st_1}) \sinh(\sqrt{st_1}) \cosh(\sqrt{st_2}) \}. \quad (2.202)$$

For $s = s_j$ the values of the parameters in equation (2.202) are $\sqrt{s_j t_2} = ix_j$ and $\sqrt{s_j t_1} = i\beta x_j$, with β defined by equation (2.201). It follows that

$$s_j Q_1'(s_j) = -\frac{1}{2} x_j \{ (1 + \alpha\beta) \cos(\beta x_j) \sin(x_j) + (\alpha + \beta) \sin(\beta x_j) \cos(x_j) \}. \quad (2.203)$$

Noting that $P(0)/Q(0) = 1$ in both the expressions (2.192) and (2.193), the final solution for the pressure in the two regions can now be obtained from equation (2.195) as

$$z > 0 : \quad \frac{p_1}{p_0} = 2 \sum_{j=1}^{\infty} \frac{\cos(x_j) \cos(\beta x_j z/h_1) - \alpha \sin(x_j) \sin(\beta x_j z/h_1)}{(1 + \alpha\beta) \cos(\beta x_j) \sin(x_j) + (\alpha + \beta) \sin(\beta x_j) \cos(x_j)} \frac{\exp(-x_j^2 t/t_2)}{x_j}, \quad (2.204)$$

$$z < 0 : \quad \frac{p_2}{p_0} = 2 \sum_{j=1}^{\infty} \frac{\cos(x_j) \cos(x_j z/h_2) - \sin(x_j) \sin(x_j z/h_2)}{(1 + \alpha\beta) \cos(\beta x_j) \sin(x_j) + (\alpha + \beta) \sin(\beta x_j) \cos(x_j)} \frac{\exp(-x_j^2 t/t_2)}{x_j}. \quad (2.205)$$

This completes the solution of the first problem.

Graphics

The computations described above can be performed by a computer program "C2L", written in C++. The program also shows the results of a numerical solution, using a one-dimensional finite element model (Verruijt, 1995), with a time step parameter ϵ that should be chosen in the interval $0.5 < \epsilon \leq 1$ to guarantee stability of the numerical process (Booker & Small, 1974). A value $\epsilon = 1$ indicates a backward interpolation in each time step.

An example is shown in Figure 2.15, for a system of two layers. The thickness of the upper layer is 1 m, and its permeability is 1 m/d. The thickness of the lower layer is 2 m, and its permeability is 0.1 m/d. The compressibility of both layers is 0.1 m²/kN. The figure shows the pore pressures after 5 days. The results of the analytical solution are shown by a continuous red line. The results of a finite element computation, using linear one-dimensional elements, are shown by dots.

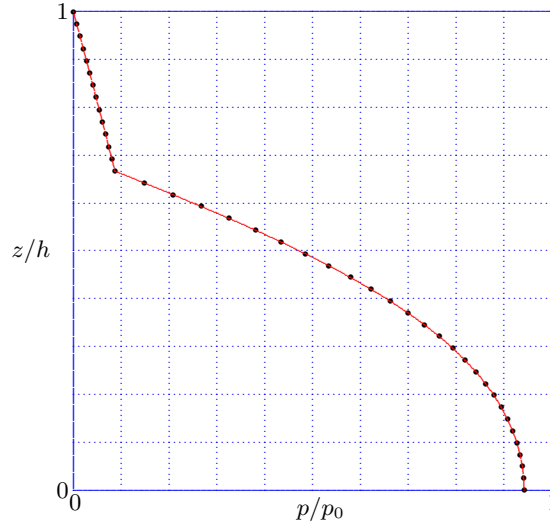

Figure 2.15: Solution of first problem, permeability contrast 10:1.

2.5.2 The second problem

As a second case the problem for a system that is fully drained at its top and at its bottom will be considered. In this case the third boundary condition, equation (2.176), should be replaced by the condition

$$z = -h_2 : p_2 = 0. \quad (2.206)$$

In this case the four integration constants in the transformed solution are

$$A = -\frac{p_0}{s} \frac{\alpha \cosh(q_2 h_2) - \alpha \cosh(q_1 h_1)}{Q_2}, \quad (2.207)$$

$$B = -\frac{p_0}{s} \frac{\sinh(q_2 h_2) + \alpha \sinh(q_1 h_1)}{Q_2}, \quad (2.208)$$

$$C = -\frac{p_0}{s} \frac{\cosh(q_2 h_2) - \cosh(q_1 h_1)}{Q_2}, \quad (2.209)$$

$$D = -\frac{p_0}{s} \frac{\sinh(q_2 h_2) + \alpha \sinh(q_1 h_1)}{Q_2}, \quad (2.210)$$

where α is the same constant as in the first case,

$$\alpha = \frac{k_2 q_2}{k_1 q_1} = \frac{\sqrt{k_2 m_2}}{\sqrt{k_1 m_1}}, \quad (2.211)$$

and Q_2 is a function of s , in this case defined as

$$Q_2 = \alpha \sinh(q_1 h_1) \cosh(q_2 h_2) + \cosh(q_1 h_1) \sinh(q_2 h_2). \quad (2.212)$$

The two solutions in the two regions now are, expressed as Laplace transforms,

$$z > 0 : \bar{p}_1 = \frac{p_0}{s} - \frac{p_0}{s} \left\{ \alpha [\cosh(q_2 h_2) - \cosh(q_1 h_1)] \sinh(q_1 z) + [\sinh(q_2 h_2) + \alpha \sinh(q_1 h_1)] \cosh(q_1 z) \right\} / Q_2, \quad (2.213)$$

$$z < 0 : \bar{p}_2 = \frac{p_0}{s} - \frac{p_0}{s} \left\{ [\cosh(q_2 h_2) - \cosh(q_1 h_1)] \sinh(q_2 z) + [\sinh(q_2 h_2) + \alpha \sinh(q_1 h_1)] \cosh(q_2 z) \right\} / Q_2, \quad (2.214)$$

It can easily be verified that these expressions satisfy the four boundary conditions, provided that the constant α is given by the definition (2.211).

Again the inverse Laplace transform can be obtained using the theorem (2.195). It should be noted that the singularity $s = 0$ in the expressions (2.213) and (2.214) are of order 1. The expression $Q_2(s)$ may contain a factor \sqrt{s} for $s \rightarrow 0$, but this is balanced by a similar factor in the numerator of the expressions. In this case the function $Q_2(s)$ can be written as

$$Q_2 = \alpha \sinh(\sqrt{st_1}) \cosh(\sqrt{st_2}) + \cosh(\sqrt{st_1}) \sinh(\sqrt{st_2}), \quad (2.215)$$

where t_1 and t_2 are given by equation (2.198).

If it is again assumed that all zeroes of $Q_2(s)$ are imaginary, as defined in equation (2.199), the zeroes can be determined from the condition

$$Q_2 = i\alpha \sin(\beta x) \cos(x) + i \cos(\beta x) \sin(x) = 0, \quad (2.216)$$

where, as before, $\beta = \sqrt{t_1/t_2}$.

The zeroes of Q_2 can be determined in the same iterative way as in the previous case. In this case the function $sQ_2'(s)$ can be evaluated by differentiation of the expression (2.215). This gives

$$sQ_2'(s) = \frac{1}{2} \{ (\alpha\sqrt{st_1} + \sqrt{st_2}) \cosh(\sqrt{st_1}) \cosh(\sqrt{st_2}) + (\alpha\sqrt{st_2} + \sqrt{st_1}) \sinh(\sqrt{st_1}) \sinh(\sqrt{st_2}) \}. \quad (2.217)$$

For $s = s_j$ the values of the parameters in equation (2.202) are $\sqrt{s_j t_2} = ix_j$ and $\sqrt{s_j t_1} = i\beta x_j$, with β defined by equation (2.201). It follows that

$$s_j Q_2'(s_j) = \frac{ix_j}{2} \left\{ (1 + \alpha\beta) \cos(\beta x_j) \cos(x_j) - (\alpha + \beta) \sin(\beta x_j) \sin(x_j) \right\}. \quad (2.218)$$

The final solution for the pressure in the two regions can now be obtained from equation (2.195) as

$$z > 0 : \frac{p_1}{p_0} = -2 \sum_{j=1}^{\infty} \left\{ \alpha [\cos(x_j) - \cos(\beta x_j)] \sin(\beta x_j z / h_1) + [\sin(x_j) + \alpha \sin(\beta x_j)] \cos(\beta x_j z / h_1) \right\} \frac{\exp(-x_j^2 t / t_2)}{x_j R(x_j)}, \quad (2.219)$$

$$z < 0 : \frac{p_1}{p_0} = -2 \sum_{j=1}^{\infty} \left\{ [\cos(x_j) - \cos(\beta x_j)] \sin(x_j z / h_2) + [\sin(x_j) + \alpha \sin(\beta x_j)] \cos(x_j z / h_2) \right\} \frac{\exp(-x_j^2 t / t_2)}{x_j R(x_j)}, \quad (2.220)$$

where

$$R(x_j) = (1 + \alpha\beta) \cos(\beta x_j) \cos(x_j) - (\alpha + \beta) \sin(\beta x_j) \sin(x_j). \quad (2.221)$$

This completes the solution of the second problem.

Graphics

The computations described above can also be performed by the computer program "C2L", mentioned before, using the option of a drained bottom.

Results are shown in Figure 2.16, for a system of two layers. The thickness of the upper layer is 1 m, and its permeability is 1 m/d. The thickness of the lower layer is 2 m, and its permeability is 0.1 m/d. The compressibility of both layers is 0.1 m²/kN. The figure shows the pore pressures after 5 days. The results of the analytical solution are shown by a continuous red line. The results of a finite element computation, using linear one-dimensional elements, are shown by dots.

Solutions for large permeability contrasts

The examples shown above, in Figures 2.15 and 2.16 apply to problems in which the permeability contrast between the two layers is 10. In engineering practice much larger permeability contrasts may occur, for instance in the case of a sand layer on top of a clay layer, or the case of a clay layer on top of a sand layer.

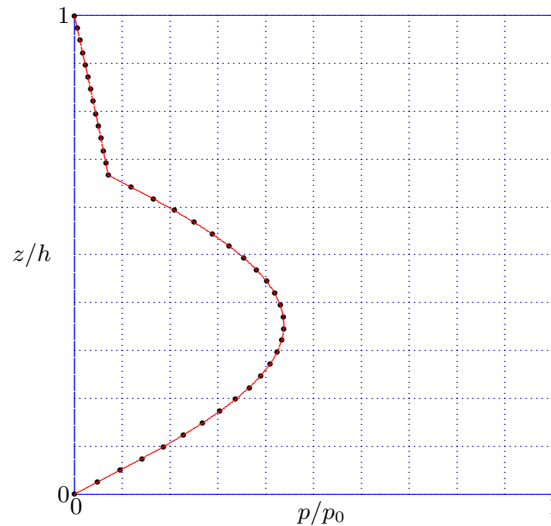

Figure 2.16: Solution of second problem, permeability contrast 10:1.

For the large permeability contrasts that may occur in such problems, up to a factor 10^6 , the analytical solution may require many terms (1000 or more) before convergence is achieved, and the numerical solution may lead to difficulties in the approximation in the vicinity of the transition surface. Also, the time scale of consolidation in the two zones is very different. Actually in such problems it seems more reasonable to disregard the gradient in the more permeable zone, or to disregard the flux in the less permeable zone. Another improvement may be to use large elements in the high permeability zone and much smaller elements in the low permeability zone, so that the time scales in the two zones become of comparable magnitude.

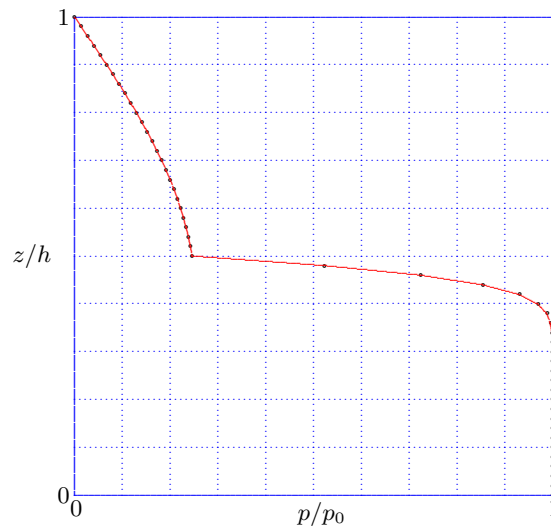

Figure 2.17: Two layered soil, permeability contrast 100:1.

Figure 2.17 shows the solution for a problem in which the permeability in the top half is a factor 100 larger than the permeability in the lower half. The analytical solution is shown by a continuous red line, the finite element solution, obtained using the program described in the next section, is shown by small dots.

Figure 2.18 shows the analytical and numerical solutions for a problem in which the permeability in the lower half is a factor 100 larger than the permeability in the upper half. In a problem like this, where all the water from the lower layer must be supplied through the system by the drainage at the top, the analytical solution requires many terms.

The analytical solution method used in this section can in principle be generalized to a system of three and even more layers. However, the solution then becomes more and more complicated, and it is considered more practical to apply a direct numerical method. In the next section such a numerical method is presented, which

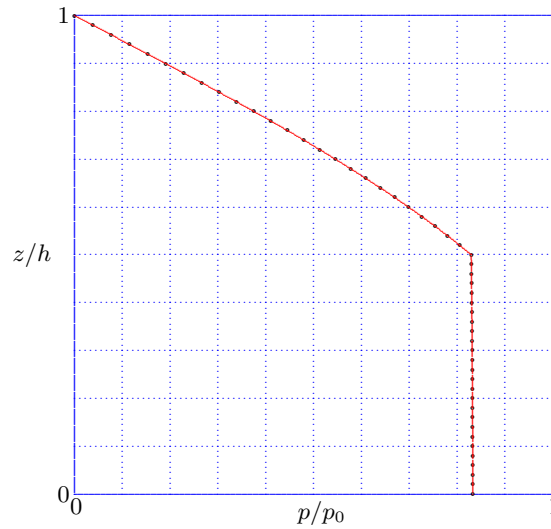

Figure 2.18: Two-layered soil, permeability contrast 1:100.

makes it possible to produce a solution for a system consisting of many layers having different properties.

2.6 One-dimensional finite elements

This section presents the analysis of one-dimensional consolidation problems by the finite element method, see Figure 2.19. Probably the first to present a numerical solution to a problem of consolidation of a layered soil was Abbott (1960), using the finite difference method. This method has been superseded by the finite element method, which is more convenient for variable soil properties. The soil column in the figure is subdivided into a number of elements, which may have different properties. The height of the elements may also be variable. For principles and details of the finite element method see for instance Zienkiewicz (1977) and Bathe (1982). Some applications of the numerical method presented have already been shown in the previous section 2.5, see Figures 2.15 – 2.18.

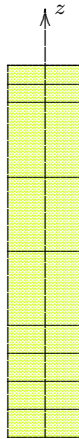

Figure 2.19: Soil column.

2.6.1 Basic equations

The basic differential equation of one-dimensional poroelasticity is, for a non-homogeneous soil, see Chapter 1,

$$m \frac{\partial p}{\partial t} = \frac{\partial}{\partial z} \left(\frac{k}{\gamma} \frac{\partial p}{\partial z} \right), \quad (2.222)$$

where m is the effective compressibility of the soil, k is the permeability, and γ is the volumetric weight of the fluid (water). In general, for a soil with a compressible fluid and compressible particles, the effective compressibility of the soil is $m = S + \alpha^2 / (K + \frac{4}{3}G) = S + \alpha^2 m_v$. For a soil with an incompressible fluid and incompressible particles the effective compressibility is $m = m_v = 1 / (K + \frac{4}{3}G)$. It should be emphasized that the basic differential equation in the finite element method, equation (2.222) applies to a soil with variable permeability. This variability is automatically taken into account in the development of the numerical equations, without any need for a separate treatment of the continuity of the flow at an interface between two regions with different permeabilities. This is a distinct advantage of the finite element method over the finite difference method.

The most common boundary conditions are that at the two boundaries either the pore pressure or the specific discharge is prescribed. It will be assumed here that these boundary conditions are

$$z = 0 : \frac{k}{\gamma} \frac{\partial p}{\partial z} = 0, \quad (2.223)$$

$$z = h : p = 0. \quad (2.224)$$

The initial condition is assumed to be

$$t = 0 : p = p_0. \quad (2.225)$$

This initial condition applies in case of a load that is applied at time $t = 0$, and then remains constant.

The most common method of solution is to calculate the values of the pore pressure p in successive time steps. The appropriate equation may be obtained by integrating the differential equation (2.223) over a time step Δt . This gives, for a certain point in the soil column,

$$\Delta t \frac{d}{dz} \left(\frac{k}{\gamma} \frac{d\bar{p}}{dz} \right) - m[p(t + \Delta t) - p(t)] = 0, \quad (2.226)$$

where \bar{p} is the average value of the pore pressure during the time step. It is assumed that this can be written as

$$\bar{p} = (1 - \epsilon)p(t) + \epsilon p(t + \Delta t), \quad (2.227)$$

where ϵ is an interpolation parameter, $0 < \epsilon < 1$. This parameter can be used to simulate various interpolation schemes. A value $\epsilon = 1$ indicates a backward interpolation, because in that case the value during the entire time step; is determined by the value at the end of the time step. A value $\epsilon = 0$ indicates a forward interpolation, because then the value during the entire time step is determined by the value at the beginning of the time step. Linear interpolation, which may seem the most realistic, corresponds to the value $\epsilon = \frac{1}{2}$. Actually, it has been shown by Booker & Small (1974) that the process is stable only if $\frac{1}{2} < \epsilon \leq 1$. It is therefore suggested to always use $\epsilon = \frac{1}{2}$, or a value somewhat larger.

It follows from equation (2.227) that

$$p(t + \Delta t) - p(t) = \frac{\bar{p} - p(t)}{\epsilon}, \quad (2.228)$$

and equation (2.226) then gives, writing $p(t) = p$,

$$\frac{d}{dz} \left(\frac{k}{\gamma} \frac{d\bar{p}}{dz} \right) - \frac{m}{\epsilon \Delta t} (\bar{p} - p) = 0. \quad (2.229)$$

If the average pore pressure during a time step \bar{p} can be calculated using equation (2.229), the value at the end of the time step can be determined from equation (2.228), and then a next time step can be taken.

2.6.2 Variational principle

There are several methods to establish the system of numerical equations for the finite element method. In this section the equations will be derived using a variational principle. This principle is that the solution of the differential equation (2.229) can be obtained as the minimum of the functional

$$U = \frac{1}{2} \int_0^h \left\{ \frac{k}{\gamma} \left(\frac{df}{dz} \right)^2 + \frac{m}{\epsilon \Delta t} (f^2 - 2fp) \right\} dz, \quad (2.230)$$

where f is an arbitrary function of z , except that it is required that for $z = h$: $f = 0$, indicating that the boundary condition (2.224) should be satisfied. The other quantities in the expression (2.230) are the same as in equation (2.229).

An example of a possible function $f(z)$ is shown in Figure 2.20, assuming linear interpolation in each element.

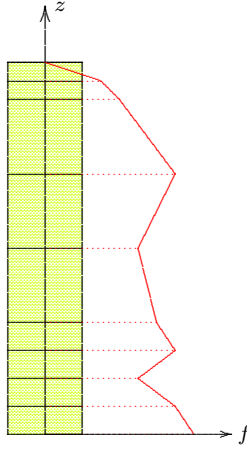

Figure 2.20: Function $f(z)$.

The proof that the function $f = \bar{p}$ leads to a minimum of the functional U can be given as follows.

Let it first be assumed that $U = U_0$ if $f = \bar{p}$. Next assume that f is different from \bar{p} , say $f = \bar{p} + \alpha u$, where α is an arbitrary constant, and u is an arbitrary function of z except that for $z = 0$: $u = 0$, which is necessary because both f and \bar{p} are equal to 0 for $z = 0$. The functional U then is

$$U = \frac{1}{2} \int_0^h \left\{ \frac{k}{\gamma} \left[\frac{d(\bar{p} + \alpha u)}{dz} \right]^2 + \frac{m}{\epsilon \Delta t} [(\bar{p} + \alpha u)^2 - 2(\bar{p} + \alpha u)p] \right\} dz. \quad (2.231)$$

Elaborating this expression will give three types of terms with various powers of α , so that it can be written as

$$U = U_0 + \alpha A_1 + \alpha^2 A_2, \quad (2.232)$$

where

$$A_1 = \int_0^h \left\{ \frac{k}{\gamma} \frac{d\bar{p}}{dz} \frac{du}{dz} + \frac{m}{\epsilon \Delta t} (\bar{p} - p)u \right\} dz, \quad (2.233)$$

$$A_2 = \frac{1}{2} \int_0^h \left\{ \frac{k}{\gamma} \left(\frac{du}{dz} \right)^2 + \frac{m}{\epsilon \Delta t} u^2 \right\} dz. \quad (2.234)$$

The expression for A_2 consists of squares, with all coefficients being positive. Hence

$$A_2 > 0. \quad (2.235)$$

The expression for A_1 can be transformed to

$$A_1 = \int_0^h \left\{ \frac{d}{dz} \left(\frac{k}{\gamma} u \frac{d\bar{p}}{dz} \right) \right\} dz - \int_0^h u \left\{ \frac{d}{dz} \left(\frac{k}{\gamma} \frac{d\bar{p}}{dz} \right) - \frac{m}{\epsilon \Delta t} (\bar{p} - p) \right\} dz. \quad (2.236)$$

The expression between brackets in the second integral is zero, because \bar{p} is the solution of equation (2.229). The first integral can directly be integrated, so that

$$A_1 = \frac{k}{\gamma} u \frac{d\bar{p}}{dz} \Big|_{z=h} - \frac{k}{\gamma} u \frac{d\bar{p}}{dz} \Big|_{z=0}. \quad (2.237)$$

The first term is zero, because $u = 0$ for $z = h$, and the second term is zero because of the boundary condition (2.223). It follows that

$$A_1 = 0. \quad (2.238)$$

With equations (2.235) and (2.238) it follows from equation (2.232) that

$$U > U_0, \quad (2.239)$$

which completes the proof of the variational principle.

2.6.3 Finite elements

The soil column of height h is subdivided into n finite elements, denoted as R_ℓ , $\ell = 1, \dots, n$. The functional U can now be expressed as

$$U = \sum_{\ell=1}^n U_\ell, \quad (2.240)$$

where

$$U_\ell = \frac{1}{2} \int_{z_1}^{z_2} \left\{ \frac{k}{\gamma} \left(\frac{df}{dz} \right)^2 + \frac{m}{\epsilon \Delta t} (f^2 - 2fp) \right\} dz. \quad (2.241)$$

It is assumed (temporarily) that element ℓ is located between the two points at levels z_1 and z_2 . In this element the function f (the approximation of the average pore pressure \bar{p}) is assumed to be given by a linear interpolation,

$$z_1 < z < z_2 : f = az + b, \quad (2.242)$$

where

$$a = \frac{c_1 f_1 + c_2 f_2}{z_2 - z_1}, \quad b = \frac{d_1 f_1 + d_2 f_2}{z_2 - z_1}, \quad (2.243)$$

with

$$c_1 = -1, \quad c_2 = 1, \quad d_1 = z_2, \quad d_2 = -z_1. \quad (2.244)$$

It follows that

$$z_1 < z < z_2 : \frac{df}{dz} = a = \frac{c_1 f_1 + c_2 f_2}{z_2 - z_1} = \frac{1}{\Delta z} \sum_{i=1}^2 c_i f_i, \quad (2.245)$$

where

$$\Delta z = z_2 - z_1. \quad (2.246)$$

It now follows that the first part of the integral (2.241) is, noting that the length of the integration interval from z_1 to z_2 is Δz ,

$$U_{\ell 1} = \frac{1}{2} \int_{z_1}^{z_2} \frac{k}{\gamma} \left(\frac{df}{dz} \right)^2 = \frac{1}{2} \frac{k}{\gamma} \frac{1}{\Delta z} \sum_{i=1}^2 \sum_{j=1}^2 c_i c_j f_i f_j. \quad (2.247)$$

For the evaluation of the second part of the integral (2.241) it may be noted that

$$f^2 = a^2 z^2 + 2abz + b^2. \quad (2.248)$$

Furthermore, the initial pore pressure p can be expressed by a similar linear interpolation as f ,

$$p = \frac{c_1 p_1}{z_2 - z_1} z + \frac{d_1 p_1 + d_2 p_2}{z_2 - z_1}, \quad (2.249)$$

where the coefficients c_i and d_i have the same meaning as before, see equations (2.244).

The evaluation of the second part of the integral now requires to integrate the expressions for f^2 and fp over the interval from z_1 to z_2 . Without loss of generality it may be assumed, at least temporarily, that the origin $z = 0$ coincides with the average value of z_1 and z_2 , so that $z_1 + z_2 = 0$. The necessary integrals are

$$\int_{\ell} dz = \Delta z, \quad (2.250)$$

$$\int_{\ell} z dz = 0, \quad (2.251)$$

$$\int_{\ell} z^2 dz = \frac{(\Delta z)^3}{12}. \quad (2.252)$$

Using these integrals the second part of the integral (2.241) is found to be

$$U_{\ell 2} = \frac{1}{2} \frac{m}{\epsilon \Delta t \Delta z} \sum_{i=1}^2 \sum_{j=1}^2 \left\{ d_i d_j + \frac{(\Delta z)^2}{12} c_i c_j \right\} f_i (f_j - 2p_j). \quad (2.253)$$

From equations (2.247) and (2.253) it follows that the total contribution of the element to the functional is

$$U_{\ell} = \frac{1}{2} \sum_{i=1}^2 \sum_{j=1}^2 P_{ij} f_i f_j + \frac{1}{2} \sum_{i=1}^2 \sum_{j=1}^2 R_{ij} f_i (f_j - 2p_j), \quad (2.254)$$

where

$$P_{ij} + \frac{1}{2} \frac{k}{\gamma} \frac{1}{\Delta z} c_i c_j, \quad (2.255)$$

$$R_{ij} + \frac{1}{2} \frac{m}{\epsilon \Delta t \Delta z} \left\{ d_i d_j + \frac{(\Delta z)^2}{12} c_i c_j \right\}. \quad (2.256)$$

After summation over all elements the final expression for the functional U will be of the general form (2.254), with the summation now being over all nodes, that is from $i = 0$ to $i = n$. The matrices P and R can be determined by a summation over all elements. In this (numerical) process the soil properties (k and m) and the element thickness (Δz) may be different for each element. This means that this finite element method is particularly well suited for non-homogeneous materials and layered soils with variable layer thicknesses.

Finally, the minimum value of the functional must be determined, This minimum can be found by requiring that

$$\frac{\partial U}{\partial f_k} = 0, \quad (2.257)$$

for all values f_k where the pore pressure is not prescribed by a boundary condition. Because the matrices P_{ij} and R_{ij} are symmetric this leads to the system of equations

$$\sum_{j=0}^n (P_{ij} + R_{ij}) f_j = \sum_{j=0}^n R_{ij} p_j. \quad (2.258)$$

From this system of linear algebraic equations the values of f_i may be determined, which gives an approximation of the average pore pressure in the first time step. The pore pressure at the end of the time step can then be determined from equation (2.228). By stepping forward in time, the values of the pore pressure can be obtained as functions of time.

The system of linear equations can be solved by one of the many available algorithms, for instance by Gauss elimination. For large systems, involving many points, it is worthwhile to take into account the banded structure of the matrices P and R in this process. This avoids storing many variables that are always equal to zero, and it also avoids arithmetic operations with such variables. Actually, in the present case there are only three unknowns in each equation (f_{j-1} , f_j and f_{j+1}), for which effective simple methods exist.

Some applications of the finite element method, for a system of two layers, have already been shown in section 2.5, see Figures 2.15 – 2.18.

Chapter 3

ELEMENTARY PROBLEMS

3.1 Introduction

This chapter presents the solution of some elementary problems of poroelasticity. The solution of the first three problems, due to Mandel (1953), Cryer (1963) and De Leeuw (1965), demonstrated that the three-dimensional theory of consolidation, as developed by Biot (1941), leads to solutions that are significantly different from the theory proposed by Terzaghi (1943), which is equivalent to the theory of conduction of heat in solids (Carslaw & Jaeger, 1959). The special behaviour of Biot's theory of consolidation (or *poroelasticity*) appearing in some of the problems considered in this chapter, is that in these problems the pore pressure in a sample of soil loaded by a constant load initially increases, before it later decreases to the final zero value. This type of behaviour is usually called the Mandel-Cryer effect. It has been confirmed by the results of laboratory testing (Gibson, Knight & Taylor, 1963; Verruijt, 1965).

The physical background of the Mandel-Cryer effect is that the generation of pore pressures due to the application of a load is immediate, but the dissipation due to the flow of the pore fluid is retarded by the permeability and the distance to the drainage boundary.

This chapter also presents some other elementary problems of a character similar to the problems of Mandel and Cryer, and also a general procedure to derive an approximate solution to a wide class of problems for homogeneous soils.

3.2 Mandel's problem

This section presents the solution of Mandel's problem: a rectangular soil sample subjected to a constant vertical stress at its top, through a rigid and frictionless plate of width $2a$, with drainage to the two sides in lateral direction, see Figure 3.1. The deformation of the sample is forced to be in plane strain conditions,

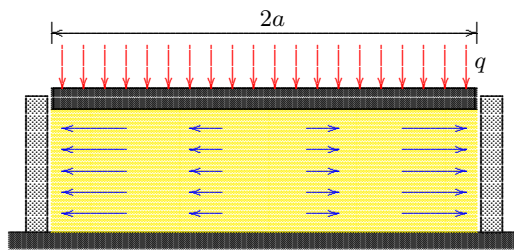

Figure 3.1: Mandel's problem.

by preventing all deformation in the direction perpendicular to the plane shown in the figure. At time $t = 0$ a uniform vertical load of magnitude q is applied, and this load is supposed to remain constant. It can be assumed that at the instant of loading the pore pressure distribution will be homogeneous, but as soon as drainage starts the pore pressures at the two sides, for $x = -a$ and $x = +a$, are reduced to zero, and the pore pressures in the interior of the sample will gradually be reduced to zero.

In this note the classical case of Mandel's original solution (Mandel, 1963), in which the fluid and the soil particles are incompressible, is considered first, mainly following the analysis of Zwanenburg (2005). Later the more general case, with compressible fluid and soil particles, will be presented, as first considered by Cheng & Detournay (1999).

3.2.1 Solution for incompressible fluid and particles

The assumption of plane strain deformation means that $\varepsilon_{yy} = 0$, from which it follows that

$$\sigma'_{yy} = -(K - \frac{2}{3}G)\varepsilon, \quad (3.1)$$

where ε is the volume strain.

Furthermore it follows from the rigidity of the loading plate, and the independence of the lateral boundary conditions of the vertical coordinate z , that the total stresses σ_{zx} and σ_{zz} may be assumed to be independent of the vertical coordinate z . From the equation of equilibrium in x -direction,

$$\frac{\partial \sigma_{xx}}{\partial x} + \frac{\partial \sigma_{zx}}{\partial z} = 0, \quad (3.2)$$

it then follows, because $\partial \sigma_{zx} / \partial z = 0$, that $\partial \sigma_{xx} / \partial x = 0$, and with the boundary condition that for $x = a$ the horizontal stress $\sigma_{xx} = 0$, it now follows that throughout the sample

$$\sigma_{xx} = 0. \quad (3.3)$$

This means that throughout the sample

$$\sigma'_{xx} = -p. \quad (3.4)$$

In general the volume strain is

$$3K\varepsilon = -(\sigma'_{xx} + \sigma'_{yy} + \sigma'_{zz}). \quad (3.5)$$

With equations (3.1) and (3.4) it follows that

$$2(K + \frac{1}{3}G)\varepsilon = 2p - \sigma_{zz}. \quad (3.6)$$

The equations given above express the relations between the stresses, the pore pressure and the volume strain for the case of Mandel's problem, using the boundary conditions.

It is interesting to note that equation (3.6) is valid for all values of time, also for the instant of loading $t = 0$. At that instant the volume strain is $\varepsilon = 0$, because the fluid and the particles are incompressible (by assumption), and no fluid can have been squeezed out of the sample. Therefore it follows from equation (3.6) that

$$t = 0 : p = \frac{1}{2}\sigma_{zz} = \frac{1}{2}q. \quad (3.7)$$

The two main equations of general poroelasticity are, in the case of incompressible particles and fluid,

$$\frac{\partial \varepsilon}{\partial t} = \frac{k}{\gamma_w} \nabla^2 p, \quad (3.8)$$

$$(K + \frac{4}{3}G) \nabla^2 \varepsilon = \nabla^2 p. \quad (3.9)$$

As observed above the stresses, the pore pressure, and the volume strain in this case are independent of y and z , so that the two equations (3.8) and (3.9) reduce to

$$\frac{\partial \varepsilon}{\partial t} = \frac{k}{\gamma_w} \frac{\partial^2 p}{\partial x^2}, \quad (3.10)$$

$$(K + \frac{4}{3}G) \frac{\partial^2 \varepsilon}{\partial x^2} = \frac{\partial^2 p}{\partial x^2}. \quad (3.11)$$

Elimination of the pore pressure from these two equations gives

$$\frac{\partial \varepsilon}{\partial t} = c_v \frac{\partial^2 \varepsilon}{\partial x^2}, \quad (3.12)$$

where c_v is the consolidation coefficient

$$c_v = \frac{k(K + \frac{4}{3}G)}{\gamma_w}. \quad (3.13)$$

The differential equation (3.12) can be solved using the Laplace transform

$$\bar{\varepsilon} = \int_0^\infty \varepsilon \exp(-st) dt. \quad (3.14)$$

After application of the Laplace transform equation (3.12) gives

$$s\bar{\varepsilon} - \varepsilon_0 = c_v \frac{d^2\bar{\varepsilon}}{dx^2}, \quad (3.15)$$

where ε_0 is the volume strain at time $t = 0$. An instantaneous volume change is impossible in this material because both the fluid and the solid particles are assumed to be incompressible, so that $\varepsilon_0 = 0$, and equation (3.15) reduces to

$$\frac{d^2\bar{\varepsilon}}{dx^2} = \frac{c_v}{s} \varepsilon. \quad (3.16)$$

The solution of this equation is, taking into account that the solution must be symmetric with respect to $x = 0$,

$$\bar{\varepsilon} = C_1 \cosh(x\sqrt{s/c_v}). \quad (3.17)$$

In order to obtain the solution for the pore pressure it may be noted that it follows from equation (3.9) that

$$p = (K + \frac{4}{3}G)\varepsilon + b, \quad (3.18)$$

where b is a function of x and t , such that $d^2b/dx^2 = 0$.

It follows that the Laplace transform of the pore pressure is

$$\bar{p} = (K + \frac{4}{3}G)C_1 \cosh(x\sqrt{s/c_v}) + \bar{b}. \quad (3.19)$$

The value of \bar{b} can be determined from the boundary condition for the pore pressure for $x = a$,

$$x = a : \bar{p} = 0. \quad (3.20)$$

It now follows that equation (3.19) becomes

$$\bar{p} = (K + \frac{4}{3}G)C_1 [\cosh(x\sqrt{s/c_v}) - \cosh(a\sqrt{s/c_v})]. \quad (3.21)$$

In order to determine the constant C_1 the boundary condition at the top of the sample, which prescribes the average total stress for $z = h$, must be taken into account.

The vertical total stress can be obtained using equation (3.6), or its Laplace transform

$$\bar{\sigma}_{zz} = 2\bar{p} - 2(K + \frac{1}{3}G)\bar{\varepsilon}. \quad (3.22)$$

With equations (3.17) and (3.21) this gives

$$\bar{\sigma}_{zz} = 2GC_1 \cosh(x\sqrt{s/c_v}) - 4\eta GC_1 \cosh(a\sqrt{s/c_v}), \quad (3.23)$$

where η is an auxiliary elastic constant, defined as

$$\eta = \frac{K + \frac{4}{3}G}{2G} = \frac{1 - \nu}{1 - 2\nu}. \quad (3.24)$$

The boundary condition at the top of the sample is

$$z = h : \int_0^a \sigma_{zz} dx = qaH(t), \quad (3.25)$$

where q is the (constant) average stress on the sample, and $H(t)$ is Heaviside's unit step function. The Laplace transform of the condition (3.25) is

$$z = h : \int_0^a \bar{\sigma}_{zz} dx = \frac{qa}{s}. \quad (3.26)$$

Integrating equation (3.23) gives

$$z = h : \int_0^a \bar{\sigma}_{zz} dx = 2GC_1 \sqrt{c_v/s} \sinh(a\sqrt{s/c_v}) - 4\eta GC_1 a \cosh(a\sqrt{s/c_v}). \quad (3.27)$$

It follows from equations (3.26) and (3.27) that

$$C_1 = \frac{q}{2Gs} \frac{1}{\sinh(a\sqrt{s/c_v})/(a\sqrt{s/c_v}) - 2\eta \cosh(a\sqrt{s/c_v})}. \quad (3.28)$$

Substitution of equation (3.28) into equation (3.21) gives

$$\frac{\bar{p}}{q} = \frac{\eta}{s} \frac{\cosh(x\sqrt{s/c_v}) - \cosh(a\sqrt{s/c_v})}{\sinh(a\sqrt{s/c_v})/(a\sqrt{s/c_v}) - 2\eta \cosh(a\sqrt{s/c_v})}. \quad (3.29)$$

This is the final expression for the Laplace transform of the pore pressure distribution.

The value of the pore pressure at the instant of loading can be obtained from this expression using the theorem (Carslaw & Jaeger, 1948; p. 255)

$$p_0 = \lim_{t=0} p = \lim_{s \rightarrow \infty} s\bar{p}. \quad (3.30)$$

This gives, because for large values of s the dominating terms in the numerator and the denominator are the terms containing the factor $\cosh(a\sqrt{s/c_v})$,

$$p_0 = \frac{1}{2}q, \quad (3.31)$$

which was already derived before, see equation (3.7).

Using equation (3.31) equation (3.29) can also be written as

$$\frac{\bar{p}}{p_0} = \frac{2\eta}{s} \frac{\cosh(x\sqrt{s/c_v}) - \cosh(a\sqrt{s/c_v})}{\sinh(a\sqrt{s/c_v})/(a\sqrt{s/c_v}) - 2\eta \cosh(a\sqrt{s/c_v})}. \quad (3.32)$$

The inverse Laplace transform of this equation can be obtained using Heaviside's inversion theorem (Churchill, 1972), which states that

$$\mathcal{L}^{-1}\left\{\frac{P(s)}{Q(s)}\right\} = \sum_{j=1}^n \frac{P(s_j)}{Q'(s_j)} \exp(s_j t), \quad (3.33)$$

where $Q'(s) = dQ(s)/ds$, and s_j , $j = 1, 2, 3, \dots$ are the zeroes of the function $Q(s)$, i.e. $Q(s_j) = 0$. The theorem applies only if all zeroes of $Q(s)$ are of order 1. Actually, strictly speaking, the theorem can be derived only for the case that $P(s)$ and $Q(s)$ are polynomials, with $Q(s)$ being of higher order than $P(s)$, and all zeroes of $Q(s)$ are of order one. The theorem can also be derived from the complex inversion integral of the Laplace transform, however. In applications it is suggested to always check that the solution obtained satisfies all the required conditions.

In the present case the origin, $s = 0$, is not a zero of the denominator, as can be seen by noting that the functions $\sinh(a\sqrt{s/c_v})$ and $\cosh(a\sqrt{s/c_v})$ both approach $\exp(a\sqrt{s/c_v})$ if $s \rightarrow 0$, and therefore the denominator tends towards infinity.

Zeroes of the denominator can be expected to be such that $a\sqrt{s/c_v} = i\xi$, so that

$$\sin(\xi)/\xi - 2\eta \cos(\xi) = 0, \quad (3.34)$$

or

$$\tan(\xi) = 2\eta\xi. \quad (3.35)$$

The two functions in this equation are plotted in Figure 3.2 for the case that $\nu = 0$, or $\eta = 1$. It can be seen from the figure that there is a single root in each section between $(j-1)\pi$ and $(j-1)\pi + \frac{1}{2}\pi$, for $j = 1, 2, 3, \dots$. Because for other values of ν the parameter η is always greater than 1, this property is valid for all values of ν . The zeroes can easily be calculated by a simple computer program.

The final solution for the pore pressure is

$$\frac{p}{p_0} = 2\eta \sum_{j=1}^{\infty} \frac{\cos(\xi_j x/a) - \cos(\xi_j)}{\cos(\xi_j) - \sin(\xi_j)/\xi_j + 2\eta\xi_j \sin(\xi_j)} \exp(-\xi_j^2 c_v t/a^2). \quad (3.36)$$

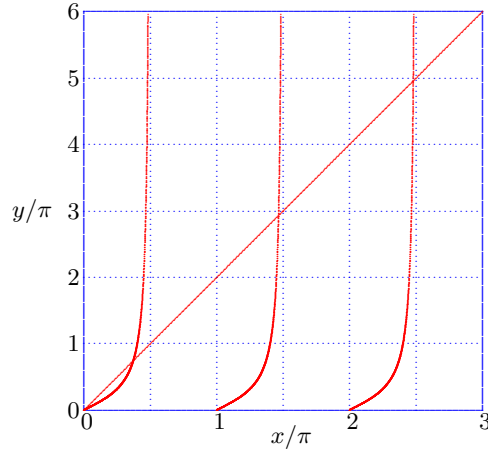
Figure 3.2: Singularities for Mandel's problem, $\nu = 0.0$.

This solution is in agreement with the expression given by Zwanenburg (2005).

Because $\sin(\xi_j)/\xi_j = 2\eta \cos(\xi_j)$, see equation (3.34), the solution can also be written in a slightly simpler form as

$$\frac{p}{p_0} = 2\eta \sum_{j=1}^{\infty} \frac{\cos(\xi_j) [\cos(\xi_j x/a) - \cos(\xi_j)]}{1 - 2\eta \cos^2(\xi_j)} \exp(-\xi_j^2 c_v t/a^2). \quad (3.37)$$

which is the form of the solution given by Mandel in his original publication (Mandel, 1953).

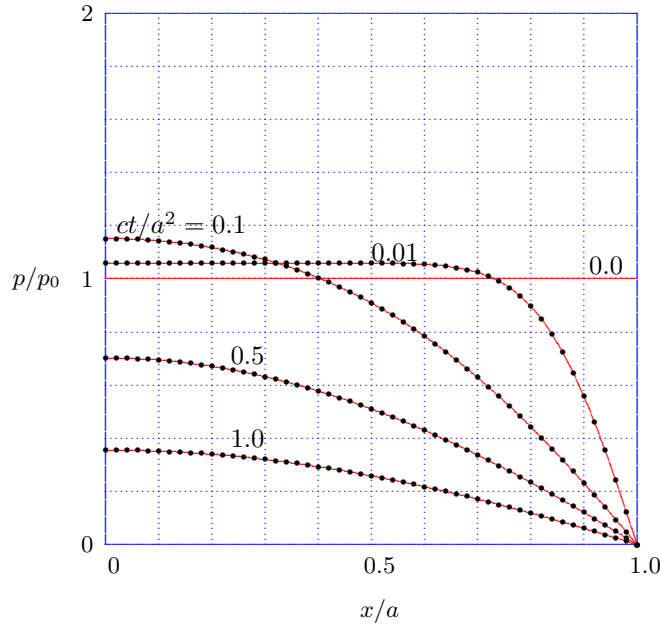
Figure 3.3: Pore pressure distribution for Mandel's problem, $\nu = 0.1$.

The distribution of the pore pressure is shown in Figure 3.3, for the case $\nu = 0.1$, and various values of time, by the red lines. The dots indicate the results of an approximate solution using Talbot's method for the inverse Laplace transform. In this method, with the Laplace transform of a function $F(t)$ denoted by $f(s)$, the algorithm for the computation of an approximation $F(t, M)$ is (Abate & Whitt, 2006)

$$F(t, M) \approx \frac{2}{5t} \sum_{k=0}^{M-1} \Re\{\gamma_k f(\delta_k/t)\}, \quad (3.38)$$

where M is an integer indicating the number of terms in the approximation (e.g. $M = 10$ or $M = 20$), and

where

$$\delta_0 = \frac{2M}{5}, \quad \delta_k = \frac{2k\pi}{5} [\cot(k\pi/M) + i], \quad 0 < k < M, \quad (3.39)$$

$$\gamma_0 = \frac{\exp(\delta_0)}{2}, \quad \gamma_k = \left\{ 1 + i(k\pi/M)(1 + [\cot(k\pi/M)]^2) - i \cot(k\pi/M) \right\} \exp(\delta_k), \quad 0 < k < M. \quad (3.40)$$

It should be noted that for $k > 0$ the coefficients δ_k and γ_k are complex. It appears from Figure 3.3 that the approximate results obtained using the Talbot method are very close to the exact analytical results.

It is interesting to note that in the center of the sample the pore pressure initially increases beyond the value at the time of loading (p_0). As Mandel already remarked (Mandel, 1953) this must be due to the rapid reduction of the pore pressure in the vicinity of the boundary, while the total load remains constant. The effect is usually denoted as the Mandel-Cryer effect, with reference to a similar effect predicted by Cryer (1963) for a spherical sample, see the next section.

3.2.2 Generalization for compressible fluid and compressible particles

The generalization to the case of a soil with a compressible fluid and compressible particles can be made by adapting the basic equations to the more general equations.

The assumption of plane strain deformation means that again $\varepsilon_{yy} = 0$, from which it now follows that

$$\sigma'_{yy} = -(K - \frac{2}{3}G)\varepsilon, \quad (3.41)$$

where ε is the volume strain.

Furthermore it follows from the rigidity of the loading plate, and the independence of the lateral boundary conditions of the vertical coordinate z , that the total stresses σ_{zx} and σ_{zz} may be assumed to be independent of the vertical coordinate z . From the equation of equilibrium in x -direction,

$$\frac{\partial \sigma_{xx}}{\partial x} + \frac{\partial \sigma_{zx}}{\partial z} = 0, \quad (3.42)$$

it then follows, because $\partial \sigma_{zx} / \partial z = 0$, that $\partial \sigma_{xx} / \partial x = 0$, and with the boundary condition that for $x = a$ the horizontal stress $\sigma_{xx} = 0$, it now follows that throughout the sample

$$\sigma_{xx} = 0. \quad (3.43)$$

This means that throughout the sample

$$\sigma'_{xx} = -\alpha p, \quad (3.44)$$

where α is Biot's coefficient, $\alpha = 1 - C_s/C_m$, C_s is the compressibility of the solid particles and C_m is the compressibility of the soil.

In general the volume strain is

$$3K\varepsilon = -(\sigma'_{xx} + \sigma'_{yy} + \sigma'_{zz}). \quad (3.45)$$

With equations (3.41) and (3.44) it follows that

$$2(K + \frac{1}{3}G)\varepsilon = 2\alpha p - \sigma_{zz}. \quad (3.46)$$

The equations given above express the relations between the stresses, the pore pressure and the volume strain for the case of Mandel's problem, using the boundary conditions.

The two main equations of general poroelasticity are, in the case of compressible particles and fluid,

$$\alpha \frac{\partial \varepsilon}{\partial t} + S \frac{\partial p}{\partial t} = \frac{k}{\gamma_w} \nabla^2 p, \quad (3.47)$$

$$(K + \frac{4}{3}G) \nabla^2 \varepsilon = \alpha \nabla^2 p, \quad (3.48)$$

where S is the storativity, defined by $S = nC_f + (\alpha - n)C_s$, and where C_f is the compressibility of the fluid and C_s is the compressibility of the solid particles.

As observed above the stresses, the pore pressure, and the volume strain in this case are independent of y and z , so that the two equations (3.47) and (3.48) reduce to

$$\alpha \frac{\partial \varepsilon}{\partial t} + S \frac{\partial p}{\partial t} = \frac{k}{\gamma_w} \frac{\partial^2 p}{\partial x^2}, \quad (3.49)$$

$$(K + \frac{4}{3}G) \frac{\partial^2 \varepsilon}{\partial x^2} = \alpha \frac{\partial^2 p}{\partial x^2}. \quad (3.50)$$

At the instant of loading no fluid can have been expelled from the sample, so that it follows from equation (3.49) that

$$t = 0 : \alpha \varepsilon_0 + S p_0 = 0. \quad (3.51)$$

With equation (3.46) it then follows that

$$t = 0 : \frac{p_0}{\sigma_{zz}} = \frac{1}{2} \frac{\alpha}{\alpha^2 + S(K + \frac{1}{3}G)}, \quad (3.52)$$

$$t = 0 : \frac{e_0}{\sigma_{zz}} = -\frac{1}{2} \frac{S}{\alpha^2 + S(K + \frac{1}{3}G)}. \quad (3.53)$$

Taking the Laplace transforms of equations (3.49) and (3.50) gives, with (3.52) and (3.53),

$$\alpha s \bar{\varepsilon} + S s \bar{p} = \frac{k}{\gamma_w} \frac{d^2 \bar{p}}{dx^2}, \quad (3.54)$$

$$(K + \frac{4}{3}G) \frac{d^2 \bar{\varepsilon}}{dx^2} = \alpha \frac{d^2 \bar{p}}{dx^2}. \quad (3.55)$$

Integration of equation (3.55) gives

$$(K + \frac{4}{3}G) \bar{\varepsilon} = \alpha \bar{p} + \bar{b}, \quad (3.56)$$

where \bar{b} should satisfy the equation $d^2 \bar{b}/dx^2 = 0$.

Elimination of \bar{p} from equations (3.54) and (3.56) gives

$$\frac{s}{c_v} \frac{d^2 \bar{\varepsilon}}{dx^2} = \bar{\varepsilon} + \frac{S \bar{b}}{\beta}, \quad (3.57)$$

where

$$\beta = \alpha^2 + S(K + \frac{4}{3}G), \quad (3.58)$$

and

$$c_v = \frac{k}{\gamma_w} \frac{K + \frac{4}{3}G}{\beta}. \quad (3.59)$$

The solution of the differential equation (3.57) is, using the condition that $\varepsilon(-x) = \varepsilon(x)$, which follows from the symmetry of the problem,

$$\bar{\varepsilon} = -\frac{S \bar{b}}{\beta} + C_1 \cosh(x \sqrt{s/c_v}), \quad (3.60)$$

where C_1 is an integration constant.

With equation (3.56) it now follows that

$$\alpha \bar{p} = (K + \frac{4}{3}G) C_1 \cosh(x \sqrt{s/c_v}) + \frac{\alpha^2 \bar{b}}{\beta}. \quad (3.61)$$

From the boundary condition that for $x = a$: $\bar{p} = 0$ the value of \bar{b} is found to be

$$\frac{\alpha^2 \bar{b}}{\beta} = -(K + \frac{4}{3}G) C_1 \cosh(a \sqrt{s/c_v}). \quad (3.62)$$

Substitution into equation (3.61) now gives

$$\alpha\bar{p} = (K + \frac{4}{3}G)C_1 \{ \cosh(x\sqrt{s/c_v}) - \cosh(a\sqrt{s/c_v}) \}. \quad (3.63)$$

In order to determine the constant C_1 the boundary condition at the top of the sample, which prescribes the average total stress for $z = h$, must be taken into account.

The Laplace transform of this vertical total stress can be obtained using equation (3.46),

$$\bar{\sigma}_{zz} = 2\alpha\bar{p} - 2(K + \frac{1}{3}G)\bar{\varepsilon}. \quad (3.64)$$

With (3.63) and (3.60) this gives

$$\bar{\sigma}_{zz} = 2GC_1 \cosh(x\sqrt{s/c_v}) - 4\eta GC_1 \cosh(a\sqrt{s/c_v}), \quad (3.65)$$

where now

$$\eta = \frac{K + \frac{4}{3}G}{2G} \frac{\alpha^2 + S(K + \frac{1}{3}G)}{\alpha^2}. \quad (3.66)$$

If the fluid and the solid particles are incompressible $\alpha = 1$ and $S = 0$, so that η reduces to the value given in equation (3.24), and equation (3.65) reduces to (3.23), as required for a proper generalization of the previous case.

The boundary condition at the top of the sample is

$$z = h : \int_0^a \sigma_{zz} dx = qaH(t), \quad (3.67)$$

where q is the (constant) average stress on the sample, and $H(t)$ is Heaviside's unit step function. The Laplace transform of the condition (3.67) is

$$z = h : \int_0^a \bar{\sigma}_{zz} dx = \frac{qa}{s}. \quad (3.68)$$

Integrating equation (3.23) gives

$$z = h : \int_0^a \bar{\sigma}_{zz} dx = 2GC_1 \sqrt{s/c_v} \sinh(a\sqrt{s/c_v}) - 4\eta GC_1 a \cosh(a\sqrt{s/c_v}). \quad (3.69)$$

It follows from equations (3.68) and (3.69) that

$$C_1 = \frac{q}{2Gs} \frac{1}{\sinh(a\sqrt{s/c_v})/(a\sqrt{s/c_v}) - 2\eta \cosh(a\sqrt{s/c_v})}. \quad (3.70)$$

Substitution of equation (3.70) into equation (3.63) gives

$$\alpha\frac{\bar{p}}{q} = \frac{\eta}{s} \frac{\cosh(x\sqrt{s/c_v}) - \cosh(a\sqrt{s/c_v})}{\sinh(a\sqrt{s/c_v})/(a\sqrt{s/c_v}) - 2\eta \cosh(a\sqrt{s/c_v})}. \quad (3.71)$$

This is the final expression for the Laplace transform of the pore pressure distribution.

Again, the value of the pore pressure at the instant of loading can be obtained from this expression using the theorem (Carslaw & Jaeger, 1948; p. 255)

$$p_0 = \lim_{t=0} p = \lim_{s \rightarrow \infty} s\bar{p}. \quad (3.72)$$

This gives, because for large values of s the dominating terms in the numerator and the denominator are the terms containing the factor $\cosh(a\sqrt{s/c_v})$,

$$\alpha\frac{p_0}{q} = \frac{1}{2} \frac{\alpha^2}{\alpha^2 + S(K + \frac{1}{3}G)}, \quad (3.73)$$

which was already derived before, see equation (3.52).

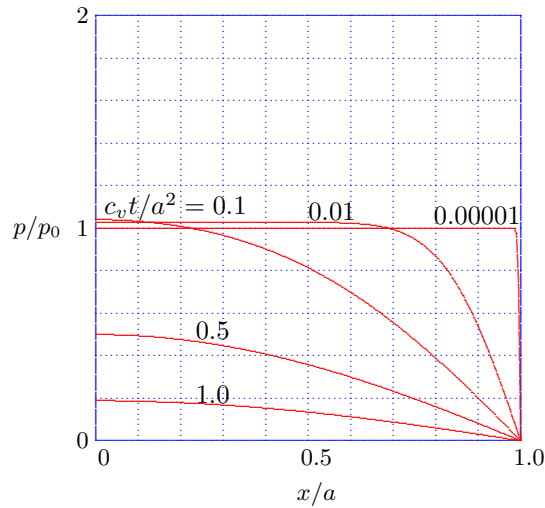

Figure 3.4: Pore pressure distribution for generalized Mandel's problem, $\nu = 0.25$.

Equation (3.71) now can be written as

$$\frac{\bar{p}}{p_0} = \frac{2\eta}{s} \frac{\cosh(x\sqrt{s/c_v}) - \cosh(a\sqrt{s/c_v})}{\sinh(a\sqrt{s/c_v})/(a\sqrt{s/c_v}) - 2\eta \cosh(a\sqrt{s/c_v})}. \quad (3.74)$$

The solution in the form of a Laplace transform in equation (3.74) is identical to the Laplace transform of the solution for the problem with incompressible constituents, as given in equation (3.32), except for the more general definition of the parameter η . This means that the final solution of the problem, as given in equation (3.36) or equation (3.37) for the case of incompressible constituents, also applies to the general case with compressible fluid and particles, except for the more general definition of η .

The computer program MANDEL can be used to show the pore pressure distribution for any given set of the input variables ν , n , C_f/C_m , C_s/C_m and $c_v t/a^2$. For the case $\nu = 0.25$ and various values of time the distribution of the pore pressure is shown in Figure 3.4. The Mandel-Cryer effect is less pronounced in this case than in Figure 3.3, which applies to the case $\nu = 0.1$. Actually, for $\nu = 0.5$ it completely disappears.

The main functions of the program MANDEL are shown below. The function `MandelParameters` calculates the values of some of the main parameters describing the problem, such as the value of the parameter η . The function `MandelRoots` calculates the values of the singularities ξ_i , for $i = 0, \dots, 200$, and the function `MandelPP` calculates the value of the pore pressure as a function of x and t .

```
//-----
void MandelParameters(void)
{
  N=200;PI=4*atan(1.0);ALPHA=1.0-CSCM;
  KS=PORO*CFM+(ALPHA-PORO)*CSCM;KSG=3*KS/(2+2*NU);
  ETA=(1-NU)*(ALPHA*ALPHA+KSG)/(ALPHA*ALPHA*(1-2*NU));
}
//-----
void MandelRoots(void)
{
  int i,j;
  double a1,a2,am,eps,y1,y2,ym;
  MandelParameters();
  eps=0.000001;
  for (i=1;i<=N;i++)
  {
    a1=(i-1)*PI+PI/4;a2=a1+PI/2-eps;
    for (j=1;j<=40;j++)
    {
      y1=tan(a1)-2*ETA*a1;y2=tan(a2)-2*ETA*a2;
      am=(a1+a2)/2;ym=tan(am)-2*ETA*am;
      if (ym*y1>0) a1=am;else a2=am;
      if (fabs(y2)<eps) am=a2;
    }
    ZERO[i]=am;
  }
}
```

```

}
}
//-----
double MandelPP(double x,double t)
{
  int i;
  double p,a,b,s,c,cx;
  MandelRoots();
  p=0;
  for (i=1;i<=N;i++)
  {
    s=sin(ZERO[i]);c=cos(ZERO[i]);cx=cos(x*ZERO[i]);
    a=2*ETA*ZERO[i]*s-(2*ETA-1)*c;b=ZERO[i]*ZERO[i]*t;
    if (b<20) p+=2*ETA*(cx-c)*exp(-b)/a;else i=N+1;
  }
  return(p);
}
//-----

```

3.3 Cryer's problem

This section presents the solution of Cryer's problem: a spherical soil sample, of radius a , is subjected to an all round pressure of magnitude q at its outer boundary, with drainage to a layer around the sphere, see Figure 3.5. Compared to Cryer's original solution (Cryer, 1963) the problem considered here is somewhat

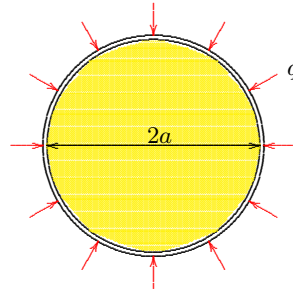

Figure 3.5: Spherical sample.

more general, because the fluid and the soil particles are considered to be compressible in this section. The influence of these additional effects on the analytical solution of the problem will appear to be marginal, however. Generalizations of the problem to problems of large strain and variable permeability were given by Gibson, Gobert & Schiffman (1989, 1990).

3.3.1 Basic equations

The first basic equation of consolidation is the continuity equation of the pore fluid,

$$\alpha \frac{\partial \varepsilon}{\partial t} + S \frac{\partial p}{\partial t} = \frac{k}{\gamma_f} \left(\frac{\partial^2 p}{\partial R^2} + \frac{2}{R} \frac{\partial p}{\partial R} \right), \quad (3.75)$$

where ε is the volume strain, p is the excess pore pressure, α is Biot's coefficient, k is the coefficient of permeability, γ_f is the volumetric weight of the pore fluid, and S is a storage coefficient, defined as

$$S = nC_f + (\alpha - n)C_s. \quad (3.76)$$

Here n is the porosity, C_f is the compressibility of the fluid, and C_s is the compressibility of the solid particles. In the case of incompressible constituents $S = 0$ and $\alpha = 1$.

The volume strain ε is related to the radial displacement u by

$$\varepsilon = \frac{\partial u}{\partial R} + \frac{2u}{R}, \quad (3.77)$$

which can also be written in the compact form

$$\varepsilon = \frac{1}{R^2} \frac{\partial (uR^2)}{\partial R}. \quad (3.78)$$

The second basic equation is the equation of radial equilibrium, which can be expressed as

$$\frac{\partial \sigma_{RR}}{\partial R} + 2 \frac{\sigma_{RR} - \sigma_{TT}}{R} = 0, \quad (3.79)$$

where σ_{RR} and σ_{TT} are the total stresses in radial and tangential direction. The total stresses can be separated into the effective stresses and the pore pressure by the equations

$$\sigma_{RR} = \sigma'_{RR} + \alpha p, \quad \sigma_{TT} = \sigma'_{TT} + \alpha p. \quad (3.80)$$

Using these relations the equation of equilibrium can be written as

$$\frac{\partial \sigma'_{RR}}{\partial R} + 2 \frac{\sigma'_{RR} - \sigma'_{TT}}{R} + \alpha \frac{\partial p}{\partial R} = 0. \quad (3.81)$$

Using equation (3.77) and the stress-strain-relations

$$\sigma'_{RR} = -(K - \frac{2}{3}G)\varepsilon - 2G \frac{\partial u}{\partial R}, \quad \sigma'_{TT} = -(K - \frac{2}{3}G)\varepsilon - 2G \frac{u}{R}, \quad (3.82)$$

the equation of equilibrium can be expressed in terms of the volume strain as

$$(K + \frac{4}{3}G) \frac{\partial \varepsilon}{\partial R} = \alpha \frac{\partial p}{\partial R}. \quad (3.83)$$

In these equations K is the compression modulus of the porous medium in fully drained conditions, and G is its shear modulus.

3.3.2 Solution of the problem

The problem is further defined by the boundary conditions

$$R = 0 : \frac{\partial p}{\partial R} = 0. \quad (3.84)$$

$$R = 0 : u = 0, \quad (3.85)$$

$$R = a : p = 0. \quad (3.86)$$

$$R = a : \sigma_{RR} = \begin{cases} 0, & \text{if } t < 0, \\ q, & \text{if } t > 0. \end{cases} \quad (3.87)$$

At the instant of loading there will be a response of the sample, which can be determined by considering the sample to be elastic, with a modified compression modulus K_u , see chapter 2,

$$K_u = K + \frac{\alpha^2}{S}, \quad (3.88)$$

This leads to a solution in which the state of stress is homogenous, with all normal stresses being equal to the load q . The initial volume strain then is

$$t = 0 : \varepsilon = \varepsilon_0 = -\frac{\frac{1}{3}(\sigma_{xx} + \sigma_{yy} + \sigma_{zz})}{K_u} = -\frac{q}{K_u} = -\frac{qS}{\alpha^2 + KS}. \quad (3.89)$$

The initial pore pressure is, because in the absence of drainage it follows from equation (3.75) that $p_0 = -\alpha \varepsilon_0 / S$,

$$t = 0 : p = p_0 = \frac{\alpha q}{\alpha^2 + KS}. \quad (3.90)$$

It may be noted that in the case of an incompressible fluid and incompressible particles $S = 0$, and $\alpha = 1$. In that case $\varepsilon_0 = 0$ and $p_0 = q$.

3.3.3 General solution

The problem can be solved using the Laplace transformation. For the pore pressure this is defined as

$$\bar{p} = \int_0^{\infty} p \exp(-st) dt, \quad (3.91)$$

where s is the Laplace transform parameter.

The transformed form of equation (3.75) is

$$\alpha s(\bar{\varepsilon} - \varepsilon_0) + Ss(\bar{p} - p_0) = \frac{k}{\gamma_f} \left(\frac{d^2 \bar{p}}{dR^2} + \frac{2}{R} \frac{d\bar{p}}{dR} \right). \quad (3.92)$$

With (3.89) and (3.90) and the introduction of $\bar{p}R$ as a new variable this can be written as

$$\alpha s \bar{\varepsilon} + Ss \bar{p} = \frac{k}{\gamma_f} \frac{1}{R} \frac{d^2(\bar{p}R)}{dR^2}. \quad (3.93)$$

The transformed form of equation (3.83) is

$$\left(K + \frac{4}{3}G \right) \frac{d\bar{\varepsilon}}{dR} = \alpha \frac{d\bar{p}}{dR}. \quad (3.94)$$

This equation can be integrated to give

$$\left(K + \frac{4}{3}G \right) \bar{\varepsilon} = \alpha \bar{p} + P, \quad (3.95)$$

where P is an integration constant.

It follows from (3.93) and (3.95) that

$$\frac{d^2(\bar{p}R)}{dR^2} = \frac{s}{c_v} (\bar{p}R) + \frac{\alpha PRs}{\beta c_v}, \quad (3.96)$$

where c_v is the consolidation coefficient,

$$c_v = \frac{k}{\gamma_f} \frac{K + \frac{4}{3}G}{\alpha^2 + S(K + \frac{4}{3}G)}, \quad (3.97)$$

and β is defined by

$$\beta = \alpha^2 + S(K + \frac{4}{3}G). \quad (3.98)$$

In the case of incompressible constituents $\beta = 1$, and the consolidation coefficient reduces to the classical value

$$c_v = \frac{k(K + \frac{4}{3}G)}{\gamma_f}. \quad (3.99)$$

The solution of the differential equation (3.96) is

$$\bar{p}R = A \exp(\lambda R) + B \exp(-\lambda R) - \frac{\alpha PR}{\beta}, \quad (3.100)$$

where A and B are integration constants, and

$$\lambda^2 = s/c_v. \quad (3.101)$$

With (3.95) it now follows that

$$\left(K + \frac{4}{3}G \right) \bar{\varepsilon} R = \alpha A \exp(\lambda R) + \alpha B \exp(-\lambda R) + \frac{PR(\beta - \alpha^2)}{\beta}. \quad (3.102)$$

Because $\bar{\varepsilon}R^2 = d(\bar{u}R^2)/dR$, see equation (3.78), the variable uR^2 can be obtained by integrating $\bar{\varepsilon}R^2$. This gives, after division by R^2 ,

$$(K + \frac{4}{3}G)\bar{u} = \alpha A \frac{\lambda R - 1}{(\lambda R)^2} \exp(\lambda R) - \alpha B \frac{\lambda R + 1}{(\lambda R)^2} \exp(-\lambda R) + \frac{PR(\beta - \alpha^2)}{3\beta} + \frac{D}{R^2}, \quad (3.103)$$

where D is a fourth integration constant.

It follows from equations (3.77) and the first of (3.82) that

$$\bar{\sigma}'_{RR} = -(K + \frac{4}{3}G)\bar{\varepsilon} + 4G\frac{\bar{u}}{R}, \quad (3.104)$$

so that, with (3.102) and (3.103),

$$\begin{aligned} \bar{\sigma}'_{RR} = & -\frac{\alpha A}{R} \exp(\lambda R) - \frac{\alpha B}{R} \exp(-\lambda R) - \frac{P(\beta - \alpha^2)}{\beta} \\ & + \frac{2}{m} \left[\frac{\alpha A}{R} \frac{\lambda R - 1}{(\lambda R)^2} \exp(\lambda R) - \frac{\alpha B}{R} \frac{\lambda R + 1}{(\lambda R)^2} \exp(-\lambda R) + \frac{P(\beta - \alpha^2)}{3\beta} + \frac{D}{R^3} \right], \end{aligned} \quad (3.105)$$

where m is an auxiliary material parameter, defined as

$$m = \frac{K + \frac{4}{3}G}{2G} = \frac{1 - \nu}{1 - 2\nu}. \quad (3.106)$$

The total radial stress is, because $\sigma_{RR} = \bar{\sigma}'_{RR} + \alpha p$, and with (3.100),

$$\bar{\sigma}_{RR} = \frac{2}{m} \left[\frac{\alpha A}{R} \frac{\lambda R - 1}{(\lambda R)^2} \exp(\lambda R) - \frac{\alpha B}{R} \frac{\lambda R + 1}{(\lambda R)^2} \exp(-\lambda R) + \frac{P(\beta - \alpha^2)}{3\beta} + \frac{D}{R^3} \right] - P. \quad (3.107)$$

3.3.4 Determination of the constants

The four integration constants can be determined from the boundary conditions.

From the first condition, equation (3.84), it follows that

$$B = -A. \quad (3.108)$$

This means that the expression for the pore pressure, equation (3.100), reduces to

$$\bar{p} = \frac{2A}{R} \sinh(\lambda R) - \frac{\alpha P}{\beta}, \quad (3.109)$$

with the first derivative

$$\frac{d\bar{p}}{dR} = \frac{2A}{R^2} [(\lambda R) \cosh(\lambda R) - \sinh(\lambda R)]. \quad (3.110)$$

Because for small values of x : $x \cosh(x) - \sinh(x) \approx \frac{1}{3}x^3$ it follows that the boundary condition (3.84) now is indeed satisfied.

The expression for the displacement, equation (3.103) now becomes

$$(K + \frac{4}{3}G)\bar{u} = \frac{2\alpha A}{(\lambda R)^2} [(\lambda R) \cosh(\lambda R) - \sinh(\lambda R)] + \frac{PR(\beta - \alpha^2)}{3\beta} + \frac{D}{R^2}, \quad (3.111)$$

For $R \rightarrow 0$ the first three terms are zero, so that the second boundary condition, equation (3.85) can be satisfied only if

$$D = 0. \quad (3.112)$$

The third boundary condition, equation (3.86) gives

$$P = \frac{2A\beta}{\alpha a} \sinh(\lambda a). \quad (3.113)$$

The expression for the pore pressure, equation (3.109) now further reduces to

$$\bar{p} = 2A \left[\frac{\sinh(\lambda R)}{R} - \frac{\sinh(\lambda a)}{a} \right]. \quad (3.114)$$

Using the values obtained for the constants B , D and P , the expression for the total stress, equation (3.107) becomes

$$\bar{\sigma}_{RR} = \frac{4\alpha A}{mR(\lambda R)^2} [(\lambda R) \cosh(\lambda R) - \sinh(\lambda R)] - \frac{2A}{a\alpha} \sinh(\lambda a) \left[\beta - \frac{2}{3}(\beta - \alpha^2)/m \right]. \quad (3.115)$$

The Laplace transform of the boundary condition (3.87) is

$$R = a : \bar{\sigma}_{RR} = \frac{q}{s}. \quad (3.116)$$

It now follows from equations (3.115) and (3.116) that

$$A = -\frac{qa^3m}{4\alpha c_v} \frac{1}{[1 + \eta(\lambda a)^2/2] \sinh(\lambda a) - (\lambda a) \cosh(\lambda a)}, \quad (3.117)$$

where η is an additional parameter, defined as

$$\eta = m(1 + KS/\alpha^2) = \frac{K + \frac{4}{3}G}{2G} (1 + KS/\alpha^2). \quad (3.118)$$

In case of an incompressible fluid and incompressible particles $\eta = m = (K + \frac{4}{3}G)/(2G)$.

The final expression for the Laplace transform of the pore pressure is

$$\bar{p} = \frac{qa^2}{2\alpha c_v(1 + KS/\alpha^2)} \frac{\sinh(\lambda a) - (a/R) \sinh(\lambda R)}{[1 + \eta(\lambda a)^2/2] \sinh(\lambda a) - (\lambda a) \cosh(\lambda a)}. \quad (3.119)$$

It may be appropriate at this stage to verify the initial condition, using the property of the Laplace transform (Carslaw & Jaeger, 1948; p. 255) that

$$p_0 = \lim_{t \rightarrow 0} p = \lim_{s \rightarrow \infty} s\bar{p}. \quad (3.120)$$

With equation (3.119) this gives, because for large values of s the denominator of the second factor in equation (3.119) is dominated by the term $\eta(\lambda a)^2 \sinh(\lambda a)/2$, and because $s = c_v \lambda^2$,

$$p_0 = \frac{q}{\alpha(1 + KS/\alpha^2)}. \quad (3.121)$$

This is in agreement with equation (3.90), thus confirming the derivations.

3.3.5 The pore pressure in the center

Of particular interest is the pore pressure in the center of the sphere, at $R = 0$. If this is denoted by p_c , its Laplace transform is

$$\bar{p}_c = \frac{qa^2}{2\alpha c_v(1 + KS/\alpha^2)} \frac{\sinh(\lambda a) - \lambda a}{[1 + \eta(\lambda a)^2/2] \sinh(\lambda a) - (\lambda a) \cosh(\lambda a)}. \quad (3.122)$$

It follows from equation (3.121) that equation (3.122) can also be written as

$$\frac{\bar{p}_c}{p_0} = \frac{\eta a^2}{2c_v} \frac{\sinh(\lambda a) - \lambda a}{[1 + \eta(\lambda a)^2/2] \sinh(\lambda a) - (\lambda a) \cosh(\lambda a)}. \quad (3.123)$$

3.3.6 Inverse Laplace transformation

Inverse Laplace transformation of equation (3.123) gives, using Heaviside's inversion theorem,

$$\frac{p_c}{p_0} = \eta \sum_{j=1}^{\infty} \frac{\sin \xi_j - \xi_j}{\eta \xi_j \cos \xi_j/2 + (\eta - 1) \sin \xi_j} \exp(-\xi_j^2 c_v t/a^2), \quad (3.124)$$

where the coefficients ξ_j are the positive roots of the equation

$$(1 - \eta \xi_j^2/2) \tan \xi_j = \xi_j. \quad (3.125)$$

The solution (3.124) agrees with the solution given by Cryer (1963) and Verruijt (1965) for an incompressible fluid and incompressible particles ($\alpha = 1$ and $S = 0$). The generalization to the case of compressible particles and a compressible fluid appears to lead to the same solution, but with slightly different values for the consolidation coefficient c_v and the parameter η , see equations (3.97) and (3.118).

Although for the problem considered here a complete analytical solution has been obtained, it may be illustrative to compare that solution with the numerical inverse Laplace transformation developed by Talbot (1979).

The solution (3.124) can be illustrated by the program CRYER, in which the input parameters are ν , α and KS . Figure 3.6 shows the results for three values of Poisson's ratio ν , assuming that the pore fluid and

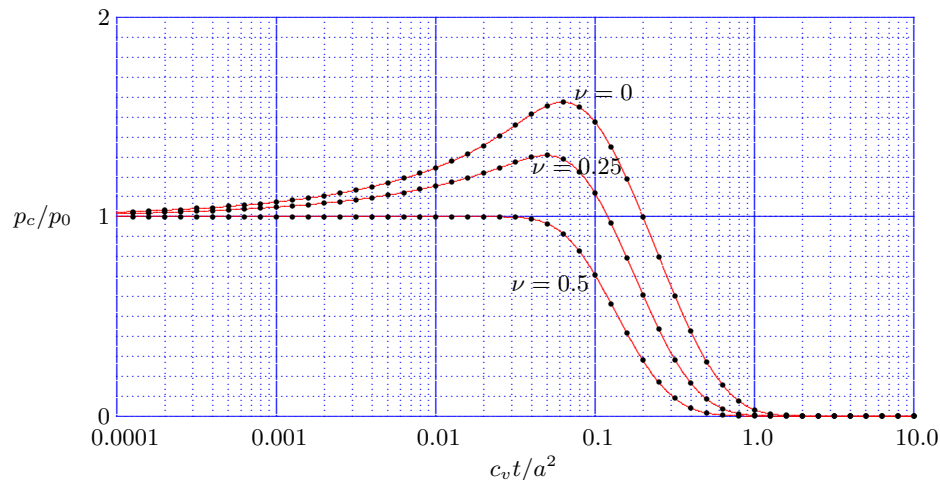

Figure 3.6: Cryer's problem : Pore pressure in the center.

the particles are incompressible, so that $\alpha = 1$ and $KS = 0$. The initial increase of the pore pressure (the Mandel-Cryer effect) has been verified experimentally by Gibson, Knight & Taylor (1963) and Verruijt (1965). That the pore pressure initially increases can be explained by noting that initially the drainage at the outer boundary results in a loss of water in the outer ring of the sample, the shrinking of which immediately leads to an increment of the total stress in the core of the sample.

In Figure 3.6 the fully drawn lines represent the analytic solution, equation (3.124). The dots indicate the results of a numerical inversion of the Laplace transform, equation (3.123), using Talbot's method with $M = 10$. Again, as in the case of Mandel's problem, considered in the previous section, the agreement appears to be excellent. Actually, the differences between the analytical and numerical solutions appear to be less than 0.000001. This is in agreement with the theoretical prediction (Abate & Whitt, 2006) that the number of significant digits in the method is about $0.6 M$.

The main functions of the program CRYER are shown below. The function `CryerParameters` calculates the values of some of the main parameters describing the problem, such as the value of the parameter η . The function `CryerRoots` calculates the values of the singularities ξ_i , for $i = 0, \dots, 200$, and the function `CryerPP` calculates the value of the pore pressure as a function of x and t .

```

//-----
void CryerParameters(void)
{
  N=200;PI=4*atan(1.0);ALPHA=1.0-CSCM;
  KS=PORO*CFCM+(ALPHA-PORO)*CSCM;
  ETA=(1-NU)*(1+KS/(ALPHA*ALPHA))/(1-2*NU);
}
//-----
void CryerRoots(void)
{
  int i,j,k;
  double a1,a2,b1,b2,eps,da;
  CryerParameters();
  eps=0.000001;
  for (j=1;j<=N;j++)
  {
    a1=eps+(2*j-1)*PI/2;da=PI;
    b1=tan(a1)*(1-ETA*a1*a1/2)-a1;
    for (i=0;i<5;i++)
    {
      for (k=0;k<N;k++)
      {
        a2=a1+da/N;b2=tan(a2)*(1-ETA*a2*a2/2)-a2;
        if (b2*b1<0) {k=N;da=a2-a1;} else {a1=a2;b1=b2;}
      }
    }
    ZERO[j]=(a1+a2)/2;
  }
}
//-----
double CryerPP(double x,double t)
{
  int i;
  double jt,b,aa,p;
  p=0;
  for (i=1;i<=N;i++)
  {
    aa=ZERO[i];
    b=(sin(aa)-aa)/(ETA*aa*cos(aa)/2+(ETA-1)*sin(aa));
    jt=aa*aa*T;
    p+=ETA*b*exp(-jt);
    if (jt>20) i=N+1;
  }
  return(p);
}
//-----

```

3.3.7 The volume change

Another interesting quantity is the volume change of the sample, as a function of time. This can be determined from the radial displacement of the outer boundary of the sphere,

$$\Delta V = 4\pi a^2 u_a, \quad (3.126)$$

where u_a is the displacement for $R = a$. The Laplace transform of this quantity is given in equation (3.111), which gives

$$(K + \frac{4}{3}G)\bar{u}_a = \frac{2\alpha A}{(\lambda a)^2} [(\lambda a) \cosh(\lambda a) - \sinh(\lambda a)] + \frac{Pa(\beta - \alpha^2)}{3\beta}, \quad (3.127)$$

where use has been made of equation (3.112), stating that the coefficient $D = 0$.

With equations (3.113), (3.117) and (3.126) it follows that

$$\Delta \bar{V} = -\frac{2\pi q a^3 m}{(K + \frac{4}{3}G)s} \frac{(\lambda a) \cosh(\lambda a) - \sinh(\lambda a) + (\lambda a)^2 \sinh(\lambda a) S(K + \frac{4}{3}G)/3\alpha^2}{[1 + \eta(\lambda a)^2/2] \sinh(\lambda a) - (\lambda a) \cosh(\lambda a)}. \quad (3.128)$$

For reasons of mathematical simplicity it will be assumed that the pore fluid and the particles are incompressible, so that $\alpha = \beta = 1$ and $S = 0$. The Laplace transform of the volume change, as given in equation

(3.128), can now be written as

$$\Delta \bar{V} = -\frac{\pi q a^3}{G} \frac{N(s)}{D(s)}, \quad (3.129)$$

where, because now $\eta = m$,

$$N(s) = (\lambda a) \cosh(\lambda a) - \sinh(\lambda a), \quad (3.130)$$

$$D(s) = s\{[1 + m(\lambda a)^2/2] \sinh(\lambda a) - (\lambda a) \cosh(\lambda a)\}. \quad (3.131)$$

Using Heaviside's theorem for the inverse Laplace transform gives

$$\Delta V = -\frac{\pi q a^3}{G} \sum_{j=0}^{\infty} \frac{N(s_j)}{D'(s_j)} \exp(s_j t), \quad (3.132)$$

where the values s_j should be determined from the equation $D(s) = 0$. The roots of this equation are

$$s_0 = 0, \quad s_j = -\xi_j^2 c_v / a^2 \quad (j = 1, \dots, \infty), \quad (3.133)$$

where, as before, in equation (3.125), the coefficients ξ_j are the positive roots of the equation

$$(1 - m\xi_j^2/2) \tan \xi_j = \xi_j, \quad (j = 1, \dots, \infty). \quad (3.134)$$

The contribution of the singularity at $s = 0$ can most easily be determined using the theorem (Carslaw & Jaeger, 1948; p. 256) that

$$\lim_{t \rightarrow \infty} \Delta V = \lim_{s \rightarrow 0} s \Delta \bar{V}. \quad (3.135)$$

This gives, using the series expansions of the functions $N(s)$ and $D(s)$ for $s \rightarrow 0$,

$$\lim_{t \rightarrow \infty} \Delta V = -\frac{qV}{K} \lim_{s \rightarrow 0} s \Delta \bar{V}, \quad (3.136)$$

where V is the volume of the sphere, $V = \frac{4}{3}\pi a^3$.

Adding the contributions of the singularities ξ_i finally gives

$$\frac{\Delta V}{V} = -\frac{q}{K} \left\{ 1 + \frac{3m-2}{2} \sum_{j=1}^{\infty} \frac{\sin(\xi_j)}{(m-1)\sin(\xi_j) + m\xi_j \cos(\xi_j)/2} \exp(-\xi_j^2 c_v t / a^2) \right\}. \quad (3.137)$$

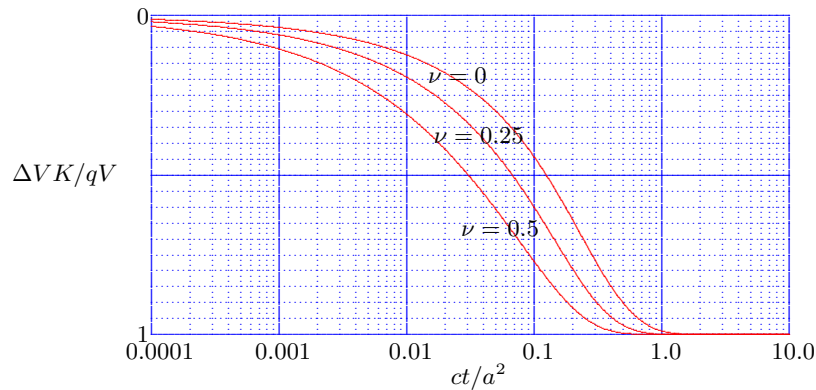

Figure 3.7: Cryer's problem : Volume change.

Figure 3.7 shows the results for three values of Poisson's ratio ν .

3.4 De Leeuw's problem

This section presents the solution of a problem with cylindrical symmetry, first considered by De Leeuw (1965). The problem is that a cylindrical soil sample, of radius a , enclosed between two stiff horizontal plates, is subjected to a uniform radial pressure of magnitude q at its outer boundary, with drainage to that outer boundary, see Figure 3.8. The soil sample is supposed to be surrounded by a drainage layer around it, and an impermeable membrane surrounding the drainage layer, so that the radial pressure can be transmitted to the sample, and drainage occurs to the outer boundary. Problems of this type and their solution were also considered by Detournay and Cheng (1993). Compared to De Leeuw's original solution the problem considered

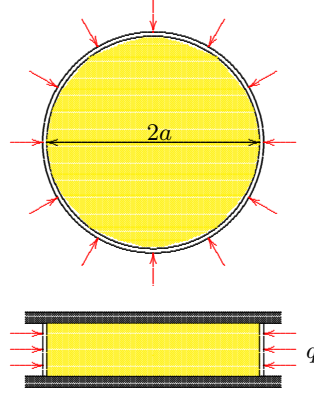

Figure 3.8: Cylindrical sample.

here is somewhat more general, because the fluid and the soil particles are considered to be compressible. The influence of these additional effects on the theoretical solution will appear to be marginal, however.

3.4.1 The elastic problem

Before solving the poroelastic problem it seems convenient to first consider the elastic problem, i.e. the problem for a dry elastic medium. The basic variable in this problem is the radial displacement u , and the strains are, assuming no strains in the vertical direction,

$$\varepsilon_{rr} = \frac{\partial u}{\partial r}, \quad \varepsilon_{tt} = \frac{u}{r}, \quad \varepsilon_{zz} = 0, \quad (3.138)$$

so that the volume strain is

$$\varepsilon = \frac{\partial u}{\partial r}. \quad (3.139)$$

The stresses are, according to Hooke's law, but considering compressive stresses as positive,

$$\sigma_{rr} = -(K - \frac{2}{3}G)\varepsilon - 2G\frac{\partial u}{\partial r}, \quad \sigma_{tt} = -(K - \frac{2}{3}G)\varepsilon - 2G\frac{u}{r}, \quad \sigma_{zz} = -(K - \frac{2}{3}G)\varepsilon. \quad (3.140)$$

The equation of equilibrium in radial direction is

$$\frac{\partial \sigma_{rr}}{\partial r} + \frac{\sigma_{rr} - \sigma_{tt}}{r} = 0. \quad (3.141)$$

Substituting the expressions for the stresses leads to

$$\frac{\partial^2 u}{\partial r^2} + \frac{1}{r} \frac{\partial u}{\partial r} + \frac{u}{r^2} = 0, \quad (3.142)$$

or, using equation (3.139),

$$\frac{\partial \varepsilon}{\partial r} = 0. \quad (3.143)$$

The solution of this equation is

$$\varepsilon = \varepsilon_0. \quad (3.144)$$

Because equation (3.139) can be written as $\varepsilon r = \partial(ur)/\partial r$ the radial displacement can be found by integration of εr . This gives

$$u = \frac{1}{2}\varepsilon_0 r, \quad (3.145)$$

where an integration constant has been omitted to ensure that for $r = 0$ the displacement is zero.

The stresses now are, with equations (3.140),

$$\sigma_{rr} = -(K + \frac{1}{3}G)\varepsilon_0, \quad \sigma_{tt} = -(K + \frac{1}{3}G)\varepsilon_0, \quad \sigma_{zz} = -(K - \frac{2}{3}G)\varepsilon_0. \quad (3.146)$$

In the case considered here the boundary condition is

$$r = a : \sigma_{rr} = q, \quad (3.147)$$

where q is the given radial stress. It follows that the volume strain is, with the first of equations (3.146),

$$\varepsilon_0 = -\frac{q}{K + \frac{1}{3}G}. \quad (3.148)$$

This means that the stresses are

$$\sigma_{rr} = q, \quad \sigma_{tt} = q, \quad \sigma_{zz} = \frac{K - \frac{2}{3}G}{K + \frac{1}{3}G} q = 2\nu q, \quad (3.149)$$

where the compression modulus K and the shear modulus G have also been related to Poisson's ratio ν .

The isotropic stress is found to be

$$\sigma_0 = \frac{1}{3}(\sigma_{rr} + \sigma_{tt} + \sigma_{zz}) = \frac{K}{K + \frac{1}{3}G} q. \quad (3.150)$$

This is in agreement with the relation $\sigma_0 = -K\varepsilon_0$, which follows directly from Hooke's law.

3.4.2 The poroelastic problem

The first basic equation of poroelasticity is the continuity equation of the pore fluid,

$$\alpha \frac{\partial \varepsilon}{\partial t} + S \frac{\partial p}{\partial t} = \frac{k}{\gamma_f} \left(\frac{\partial^2 p}{\partial r^2} + \frac{1}{r} \frac{\partial p}{\partial r} \right), \quad (3.151)$$

where ε is the volume strain, p is the excess pore pressure, α is Biot's coefficient, k is the coefficient of permeability, γ_f is the volumetric weight of the pore fluid, and S is the storativity, defined as

$$S = nC_f + (\alpha - n)C_s. \quad (3.152)$$

Here n is the porosity, C_f is the compressibility of the fluid, and C_s is the compressibility of the solid particles. In the case of incompressible constituents $S = 0$ and $\alpha = 1$. If the vertical strains are assumed to be zero ($\varepsilon_{zz} = 0$), the volume strain ε is related to the radial displacement u by

$$\varepsilon = \frac{\partial u}{\partial r} + \frac{u}{r}. \quad (3.153)$$

The second basic equation is the equation of radial equilibrium, which can be expressed as

$$\frac{\partial \sigma_{rr}}{\partial r} + \frac{\sigma_{rr} - \sigma_{tt}}{r} = 0, \quad (3.154)$$

where σ_{rr} and σ_{tt} are the total stresses in radial and tangential direction. The total stresses can be separated into the effective stresses and the pore pressure by the equations

$$\sigma_{rr} = \sigma'_{rr} + \alpha p, \quad \sigma_{tt} = \sigma'_{tt} + \alpha p. \quad (3.155)$$

Using these relations the equation of equilibrium can be written as

$$\frac{\partial \sigma'_{rr}}{\partial r} + \frac{\sigma'_{rr} - \sigma'_{tt}}{r} + \alpha \frac{\partial p}{\partial r} = 0. \quad (3.156)$$

Using equation (3.153) and the stress-strain-relations

$$\sigma'_{rr} = -(K - \frac{2}{3}G)\varepsilon - 2G\frac{\partial u}{\partial r}, \quad \sigma'_{tt} = -(K - \frac{2}{3}G)\varepsilon - 2G\frac{u}{r}, \quad (3.157)$$

the equation of equilibrium can be expressed in terms of the volume strain as

$$(K + \frac{4}{3}G)\frac{\partial \varepsilon}{\partial r} = \alpha \frac{\partial p}{\partial r}. \quad (3.158)$$

In these equations K is the compression modulus of the porous medium, and G is its shear modulus.

3.4.3 Solution of the problem

The problem is further defined by the boundary conditions

$$r = 0 : \frac{\partial p}{\partial r} = 0. \quad (3.159)$$

$$r = 0 : u = 0, \quad (3.160)$$

$$r = a : p = 0. \quad (3.161)$$

$$r = a : \sigma_{rr} = \begin{cases} 0, & \text{if } t < 0, \\ q, & \text{if } t > 0. \end{cases} \quad (3.162)$$

3.4.4 Initial state

At the instant of loading there will be a response of the sample, which can be determined by considering the sample to be elastic, with a modified compression modulus K_u ,

$$K_u = K + \frac{\alpha^2}{S}, \quad (3.163)$$

This leads to a solution as considered above, with the initial volume strain given by equation (3.148),

$$\varepsilon_0 = -\frac{q}{K_u + \frac{1}{3}G} = -\frac{qS}{\alpha^2 + S(K + \frac{1}{3}G)}. \quad (3.164)$$

The initial pore pressure is related to the initial volume change by the equation $p_0 = -\alpha\varepsilon_0/S$, see chapter 2, or equation (3.151) if the drainage effect of the last term is disregarded. This gives

$$\frac{p_0}{q} = \frac{\alpha}{\alpha^2 + S(K + \frac{1}{3}G)}. \quad (3.165)$$

It may be noted that in the case of an incompressible fluid and incompressible particles $S = 0$, and $\alpha = 1$. In that case $\varepsilon_0 = 0$ and $p_0 = q$.

3.4.5 General solution

The problem can most conveniently be solved using the Laplace transformation. For the pore pressure this is defined as

$$\bar{p} = \int_0^\infty p \exp(-st) dt, \quad (3.166)$$

where s is the Laplace transform parameter.

The transformed form of equation (3.151) is

$$\alpha s(\bar{\varepsilon} - \varepsilon_0) + Ss(\bar{p} - p_0) = \frac{k}{\gamma_f} \left(\frac{d^2 \bar{p}}{dr^2} + \frac{1}{r} \frac{d\bar{p}}{dr} \right). \quad (3.167)$$

With (3.165) and (3.164) this reduces to

$$\alpha s \bar{\varepsilon} + Ss \bar{p} = \frac{k}{\gamma_f} \left(\frac{d^2 \bar{p}}{dr^2} + \frac{1}{r} \frac{d\bar{p}}{dr} \right). \quad (3.168)$$

The transformed form of equation (3.158) is

$$\left(K + \frac{4}{3}G \right) \frac{d\bar{\varepsilon}}{dr} = \alpha \frac{d\bar{p}}{dr}. \quad (3.169)$$

This equation can be integrated to give

$$\left(K + \frac{4}{3}G \right) \bar{\varepsilon} = \alpha \bar{p} + P, \quad (3.170)$$

where P is an integration constant.

It follows from (3.168) and (3.170) that

$$\frac{d^2 \bar{p}}{dr^2} + \frac{1}{r} \frac{d\bar{p}}{dr} - \frac{s\bar{p}}{c_v} = \frac{\alpha P s}{\beta c_v}, \quad (3.171)$$

where c_v is the consolidation coefficient,

$$c_v = \frac{k}{\gamma_f} \frac{K + \frac{4}{3}G}{\beta} = \frac{k}{\gamma_f} \frac{K + \frac{4}{3}G}{\alpha^2 + S(K + \frac{4}{3}G)} \quad (3.172)$$

and β is defined by

$$\beta = \alpha^2 + S(K + \frac{4}{3}G). \quad (3.173)$$

In the case of incompressible constituents $\beta = 1$, and the consolidation coefficient reduces to the classical result

$$c_v = \frac{\kappa(K + \frac{4}{3}G)}{\gamma_f}. \quad (3.174)$$

The solution of the differential equation (3.171) is, omitting a solution that is singular in the origin,

$$\bar{p} = A I_0(\lambda r) - \frac{\alpha P}{\beta}, \quad (3.175)$$

where $I_0(x)$ is the modified Bessel functions of the first kind, A is an integration constant, and

$$\lambda^2 = s/c_v. \quad (3.176)$$

With (3.170) it now follows that

$$\left(K + \frac{4}{3}G \right) \bar{\varepsilon} = \alpha A I_0(\lambda r) + \frac{P(\beta - \alpha^2)}{\beta}. \quad (3.177)$$

Because $\bar{\varepsilon} r = d(\bar{u}r)/dr$ the radial displacement can be obtained by integrating $\bar{\varepsilon} r$.

From equation 9.6.28 in Abramowitz & Stegun (1964) it can be noted that

$$\frac{d}{dr} \{r I_1(\lambda r)\} = \lambda r I_0(\lambda r). \quad (3.178)$$

Thus it follows that integration of $\bar{\varepsilon} r$ gives

$$\left(K + \frac{4}{3}G \right) \bar{u} = \frac{\alpha A}{\lambda} I_1(\lambda r) + \frac{Pr(\beta - \alpha^2)}{2\beta} + \frac{D}{r}, \quad (3.179)$$

where D is an additional integration constant.

It follows from equations (3.153) and (3.157) that

$$\bar{\sigma}'_{rr} = -(K + \frac{4}{3}G)\bar{\varepsilon} + 2G\frac{\bar{u}}{r}, \quad (3.180)$$

so that, with (3.177) and (3.179),

$$\bar{\sigma}'_{rr} = -\alpha A I_0(\lambda r) - \frac{P(\beta - \alpha^2)}{\beta} + \frac{1}{\eta} \left\{ \alpha A \frac{I_1(\lambda r)}{\lambda r} + \frac{P(\beta - \alpha^2)}{2\beta} + \frac{D}{r^2} \right\}, \quad (3.181)$$

where η is an auxiliary material parameter, defined as

$$\eta = \frac{K + \frac{4}{3}G}{2G} = \frac{1 - \nu}{1 - 2\nu}. \quad (3.182)$$

The total radial stress is, because $\sigma_{rr} = \sigma'_{rr} + \alpha p$, and with (3.175),

$$\bar{\sigma}_{rr} = \frac{1}{\eta} \left\{ \alpha A \frac{I_1(\lambda r)}{\lambda r} + \frac{P(\beta - \alpha^2)}{2\beta} + \frac{D}{r^2} \right\} - P. \quad (3.183)$$

3.4.6 Determination of the constants

The three remaining integration constants can be determined from the boundary conditions.

The derivative of the expression for the pore pressure, equation (3.175), is

$$\frac{d\bar{p}}{dr} = -\lambda A I_1(\lambda r). \quad (3.184)$$

For $r = 0$ this is equal to zero, so that the boundary condition (3.159) now is indeed satisfied. This is of course a consequence of the omission of the second kind of Bessel function in the general solution.

In the expression for the displacement, equation (3.179), the first two terms vanish for $r \rightarrow 0$, so that the second boundary condition, equation (3.160), requires that

$$D = 0. \quad (3.185)$$

From the third boundary condition, equation (3.161), it follows, with (3.175), that

$$\frac{\alpha P}{\beta} = A I_0(\lambda a). \quad (3.186)$$

Using the values obtained for the constant P the expression for the pore pressure, equation (3.175), becomes

$$\bar{p} = A \{ I_0(\lambda r) - I_0(\lambda a) \}. \quad (3.187)$$

And the expression for the total stress, equation (3.183), becomes

$$\bar{\sigma}_{rr} = \frac{A\alpha}{\eta} \left\{ \frac{I_1(\lambda r)}{\lambda r} - 2m I_0(\lambda a) \right\}, \quad (3.188)$$

where m is an additional parameter, defined as

$$m = \frac{1}{2}\eta \frac{\alpha^2 + S(K + \frac{1}{3}G)}{\alpha^2}. \quad (3.189)$$

In case of an incompressible fluid and incompressible particles $S = 0$ and $\alpha = 1$, so that $m = \frac{1}{2}\eta = (K + \frac{4}{3}G)/(4G)$, or $m = \frac{1}{2}(1 - \nu)/(1 - 2\nu)$, which is the value given by De Leeuw (1965) for this same parameter.

The Laplace transform of the boundary condition (3.162) is

$$r = a : \bar{\sigma}_{rr} = \frac{q}{s}. \quad (3.190)$$

Using the relation $s = c\lambda^2$ it now follows from equations (3.188) and (3.190) that

$$A = -\frac{\eta qa^2}{\alpha c(\lambda a)} \frac{1}{2m(\lambda a)I_0(\lambda a) - I_1(\lambda a)}. \quad (3.191)$$

The final expression for the Laplace transform of the pore pressure is

$$\bar{p} = \frac{\eta qa^2}{\alpha c_v(\lambda a)} \frac{I_0(\lambda a) - I_0(\lambda r)}{2m(\lambda a)I_0(\lambda a) - I_1(\lambda a)}. \quad (3.192)$$

Of particular interest is the pore pressure in the center of the sphere, at $r = 0$. If this is denoted by p_c , its Laplace transform is

$$\bar{p}_c = \frac{\eta qa^2}{\alpha c_v(\lambda a)} \frac{I_0(\lambda a) - 1}{2m(\lambda a)I_0(\lambda a) - I_1(\lambda a)}. \quad (3.193)$$

It may be appropriate at this stage to verify the initial condition. A fundamental property of the Laplace transform is (Carslaw & Jaeger, 1948; p. 255)

$$\lim_{t \rightarrow 0} p = p_0 = \lim_{s \rightarrow \infty} s\bar{p}. \quad (3.194)$$

With equation (3.192) this gives, because for large values of s the denominator of the second factor in equation (3.192) is dominated by the term $2m(\lambda a)I_0(\lambda a)$,

$$\frac{p_0}{q} = \frac{\eta}{m\alpha} = \frac{\alpha}{\alpha^2 + S(K + \frac{1}{3}G)}. \quad (3.195)$$

This is in agreement with an elementary investigation of the undrained behaviour, see equation (3.165), thus confirming the derivations.

It follows from equation (3.195) that equation (3.192) can also be written as

$$\frac{\bar{p}_c}{p_0} = \frac{2ma^2}{c_v(\lambda a)} \frac{I_0(\lambda a) - I_0(\lambda r)}{2m(\lambda a)I_0(\lambda a) - I_1(\lambda a)}. \quad (3.196)$$

3.4.7 Inverse Laplace transformation

The inverse Laplace transform of the expression (3.192) can be obtained using Heaviside's inversion theorem (Churchill, 1972). For this purpose the Laplace transform is written in the form

$$\bar{w} = \frac{f(s)}{g(s)}. \quad (3.197)$$

The inverse transform then is

$$w = \sum_{j=1}^{\infty} \frac{f(s_j)}{g'(s_j)} \exp(-s_j t), \quad (3.198)$$

where s_j are the zeroes of the function $g(s)$,

$$g(s_j) = 0, \quad j = 1, 2, \dots \quad (3.199)$$

It may be noted that the point $s = 0$ is no singularity, because for $s = 0$ the factor $I_0(\lambda a) - I_0(\lambda r)$ is of order s , whereas the factor (λa) is of order \sqrt{s} .

In the present case the zeroes of the function $g(s)$ are located in points on the negative part of the real axis, which can be denoted as $s_j = -\xi_j^2 c_v/a^2$. In these points $\lambda a = i\xi$, $I_0(\lambda a) = J_0(\xi)$ and $I_1(\lambda a) = iJ_1(\xi)$. The function $g(s)$ can now be expressed into ξ as

$$g(s) = 2m(\lambda a)I_0(\lambda a) - I_1(\lambda a) = i\{2m\xi J_0(\xi) - J_1(\xi)\}. \quad (3.200)$$

Here $J_0(x)$ and $J_1(x)$ are Bessel functions of order zero and one, respectively.

The zeroes ξ_j of the expression (3.200), in its second form, can be determined by a simple computer program that searches for the points where the function between brackets changes sign.

The derivatives of the Bessel functions can be expressed using the general formulas (Abramowitz & Stegun, 1964),

$$\frac{d}{d\xi} J_0(\xi) = -J_1(\xi), \quad (3.201)$$

$$\frac{d}{d\xi} J_1(\xi) = J_0(\xi) - \frac{1}{\xi} J_1(\xi). \quad (3.202)$$

It now follows that

$$\frac{d}{d\xi} g(s) = i(4m - 4m^2\xi^2 - 1)J_0(\xi), \quad (3.203)$$

where use has been made of the knowledge that for all appropriate values of ξ the function (3.200) is zero, so that $J_1(\xi) = 2m\xi J_0(\xi)$.

The relation between s and ξ is $s = -c\xi^2/a^2$, so that $ds/d\xi = -2c\xi^2/a^2$, or $d\xi/ds = -a^2/2c\xi^2$. With (3.203) it now follows that

$$\frac{d}{ds} g(s) = -\frac{ia^2}{c\xi} (2m - 2m^2\xi^2 - \frac{1}{2}) J_0(\xi), \quad (3.204)$$

In the points $s = s_j$ the function $f(s)$ is

$$f(s_j) = \frac{2ma^2}{ic\xi_j} \{J_0(\xi_j) - J_0(\xi_j r/a)\} \quad (3.205)$$

The final expression for the pore pressure now is

$$\frac{p}{p_0} = \sum_{j=1}^{\infty} \frac{J_0(\xi_j) - J_0(\xi_j r/a)}{(1 - m\xi_j^2 - 1/4m)J_0(\xi_j)} \exp(-\xi_j^2 c_v t/a^2). \quad (3.206)$$

This result is in agreement with the expression derived by De Leeuw (1965). The only difference is the definition of the parameter m , which now also applies to the more general case of a compressible fluid and compressible solid particles, see equation (3.189). Numerical data can be calculated by the program DELEEUW.

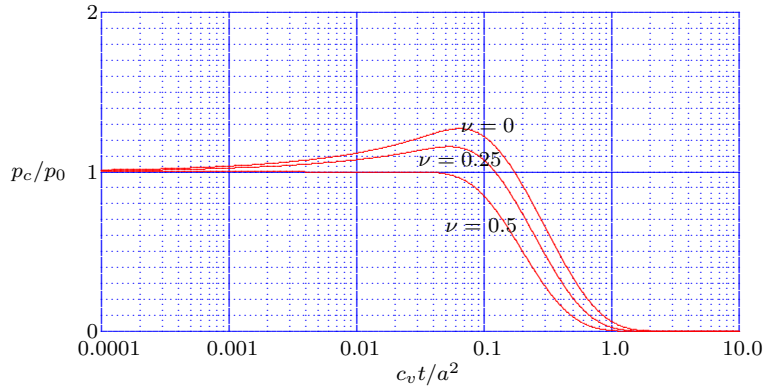

Figure 3.9: De Leeuw's problem : Pore pressure in the center.

Figure 3.9 shows the results for the pore pressure in the center, for three values of Poisson's ratio, assuming that the pore fluid and the particles are incompressible. The initial increase of the pore pressure is again the Mandel-Cryer effect considered in the previous sections.

The main functions of the program DELEEUW are shown below. The function `DeLeeuwParameters` calculates the values of some of the main parameters describing the problem, such as the value of the parameter m , denoted as `MM`. The function `DeLeeuw` calculates the values of the singularities ξ_i , for $i = 0, \dots, 200$, and the function `DeLeeuwPP` calculates the value of the pore pressure as a function of x and t . The functions `J0(u)` and `J1(u)` to calculate the Bessel functions have been taken from Abramowitz & Stegun, 1964, section 9.4.

```

//-----
double J0(double u)
{
  double a,t,f,x,xx,c1,c2,c3,c4,c5,c6,c7;
  x=fabs(u);
  if (x<3)
  {
    xx=x*x/9;c1=-2.2499997;c2=1.2656208;c3=-0.3163866;c4=0.0444479;c5=-0.0039444;c6=0.0002100;
    f=1+xx*(c1+xx*(c2+xx*(c3+xx*(c4+xx*(c5+xx*c6)))));
  }
  else
  {
    xx=3/x;c1=0.79788456;c2=-0.00000077;c3=-0.00552740;c4=-0.00009512;c5=0.00137237;c6=-0.00072805;c7=0.00014476;
    a=c1+xx*(c2+xx*(c3+xx*(c4+xx*(c5+xx*(c6+xx*c7)))));
    c1=-0.78539816;c2=-0.04166397;c3=-0.00003954;c4=0.00262573;c5=-0.00054125;c6=-0.00029333;c7=0.00013558;
    t=x+c1+xx*(c2+xx*(c3+xx*(c4+xx*(c5+xx*(c6+xx*c7)))));f=a*cos(t)/sqrt(x);
  }
  return(f);
}
//-----
double J1(double u)
{
  double a,t,f,x,xx,c1,c2,c3,c4,c5,c6,c7;
  x=fabs(u);
  if (x<3)
  {
    xx=x*x/9;c1=-0.56249985;c2=0.21093573;c3=-0.03954289;c4=0.00443319;c5=-0.00031761;c6=0.00001109;
    a=0.5+xx*(c1+xx*(c2+xx*(c3+xx*(c4+xx*(c5+xx*c6)))));f=a*x;
  }
  else
  {
    xx=3/x;c1=0.79788456;c2=0.00000156;c3=0.01659667;c4=0.00017105;c5=-0.00249511;c6=0.00113653;c7=-0.00020033;
    a=c1+xx*(c2+xx*(c3+xx*(c4+xx*(c5+xx*(c6+xx*c7)))));
    c1=-2.35619449;c2=0.12499612;c3=0.00005650;c4=-0.00637879;c5=0.00074348;c6=0.00079824;c7=-0.00029166;
    t=x+c1+xx*(c2+xx*(c3+xx*(c4+xx*(c5+xx*(c6+xx*c7)))));f=a*cos(t)/sqrt(x);
  }
  if (u<0) f=-f;
  return(f);
}
//-----
void DeLeeuwParameters(void)
{
  N=200;ALPHA=1.0-CSCM;KS=PORO*CFCM+(ALPHA-PORO)*CSCM;
  MM=(1-NU)*(1+3*KS/(2*(1+NU)*ALPHA*ALPHA))/(2*(1-2*NU));
}
//-----
void DeLeeuwRoots(void)
{
  int i;
  double x,a1,a2,am,f1,f2,fm;
  bool cont;
  DeLeeuwParameters();
  x=0;
  for (i=1;i<=N;i++)
  {
    a1=x+0.000001;a2=x+1.2*PI;f1=2*MM*a1*J0(a1)-J1(a1);f2=2*MM*a2*J0(a2)-J1(a2);
    cont=true;while (cont)
    {
      am=(a1+a2)/2;fm=2*MM*am*J0(am)-J1(am);
      if (f1*fm<0) {a2=am;f2=fm;}else if (f2*fm<0) {a1=am;f1=fm;}
      if ((a2-a1)<0.0000001) cont=false;
    }
    ZERO[i]=(a1+a2)/2;x=a2;
  }
}
//-----
double DeLeeuwPP(double x,double t)
{
  int i;
  double jt,b,aa,bb,p;
  p=0;

```

```

for (i=1;i<=N;i++)
{
  aa=ZERO[i];bb=JO(aa);b=(bb-1)/((1-MM*aa*aa-1/(4*MM))*bb);jt=aa*aa*T;
  p+=b*exp(-jt);if (jt>20) i=N+1;
}
return(p);
}
//-----

```

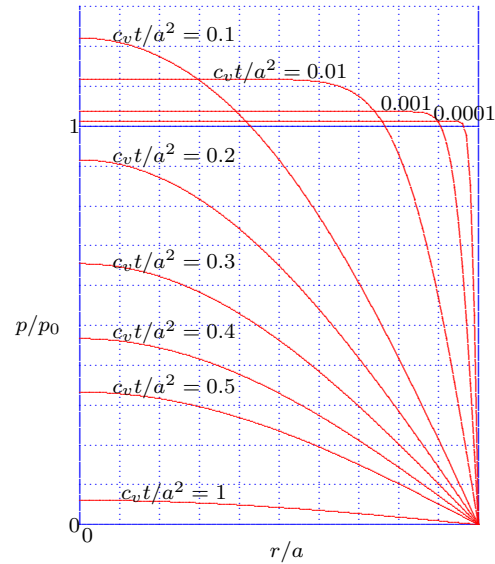

Figure 3.10: De Leeuw's problem : Pore pressures.

Figure 3.10 shows the development of the pore pressures throughout the cylinder, as time progresses.

3.5 Spherical source or sink in infinite medium

This section presents the analysis of problems of spherical symmetric elasticity or poroelasticity, as an introduction to more complex problems to be considered in a later section, involving two or more wells, or a well in a half space.

3.5.1 The elastic problem

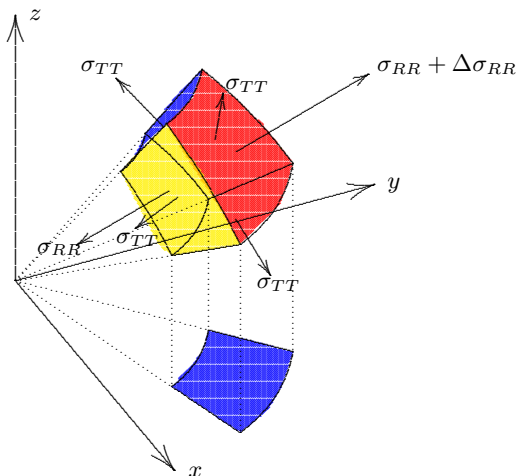

Figure 3.11: Element in spherical coordinates.

As an introduction the problem of a spherical inclusion in an infinite elastic medium is considered. It is assumed that the loading conditions are such that the displacement field is spherically symmetric, with a radial displacement u . The strains are

$$\varepsilon_{RR} = \frac{du}{dR}, \quad \varepsilon_{TT} = \frac{u}{R}. \quad (3.207)$$

And the volume strain is the sum of the three strains,

$$\varepsilon = \varepsilon_{RR} + 2\varepsilon_{TT} = \frac{du}{dR} + 2\frac{u}{R}. \quad (3.208)$$

With Hooke's law the stress-strain-relations are

$$\sigma_{RR} = -(K - \frac{2}{3}G)\varepsilon - 2G\frac{du}{dR}, \quad \sigma_{TT} = -(K - \frac{2}{3}G)\varepsilon - 2G\frac{u}{R}. \quad (3.209)$$

The equation of equilibrium in radial direction is

$$\frac{d\sigma_{RR}}{dR} + 2\frac{\sigma_{RR} - \sigma_{TT}}{R} = 0. \quad (3.210)$$

Using equations (3.208) and (3.209) the equation of equilibrium can be written as

$$\frac{d^2u}{dR^2} + 2\frac{1}{R}\frac{du}{dR} - 2\frac{u}{R^2} = 0. \quad (3.211)$$

The general solution of this equation is

$$u = AR + \frac{B}{R^2}, \quad (3.212)$$

where A and B are integration constants.

The general expression for the volume strain corresponding to the general solution (3.212) is

$$\varepsilon = 3A. \quad (3.213)$$

It appears that the deformation field corresponding to the solution B/R^2 is *isochoric*, i.e. of constant volume.

The stresses corresponding to the general solution (3.212) are, with equations (3.209),

$$\sigma_{RR} = -(K + \frac{4}{3}G)A + 4G\frac{B}{R^3}, \quad \sigma_{TT} = -(K + \frac{4}{3}G)A - 2G\frac{B}{R^3}. \quad (3.214)$$

3.5.2 Rigid spherical inclusion in infinite elastic medium

A simple example is the case of a rigid spherical inclusion in an infinite medium loaded at infinity by a given radial stress. In this case the boundary conditions are

$$R = a : u = 0, \quad R \rightarrow \infty : \sigma_{RR} = q. \quad (3.215)$$

The constants A and B now are found to be

$$A = -\frac{q}{K + \frac{4}{3}G}, \quad B = \frac{qa^3}{K + \frac{4}{3}G}. \quad (3.216)$$

The final expressions for the displacement and the stresses are

$$u = -\frac{R^3 - a^3}{R^2(K + \frac{4}{3}G)}, \quad (3.217)$$

$$\sigma_{RR} = q\left\{1 + \frac{4G}{K + \frac{4}{3}G}\frac{a^3}{R^3}\right\}, \quad \sigma_{TT} = q\left\{1 - \frac{2G}{K + \frac{4}{3}G}\frac{a^3}{R^3}\right\}. \quad (3.218)$$

At the boundary of the inclusion the displacement is zero, as required, and the stresses are

$$r = a : \sigma_{RR} = q\left\{1 + \frac{4G}{K + \frac{4}{3}G}\right\}, \quad \sigma_{TT} = q\left\{1 - \frac{2G}{K + \frac{4}{3}G}\right\}. \quad (3.219)$$

The parameters in these equations can be expressed into Poisson's ratio ν by

$$\frac{2G}{K + \frac{4}{3}G} = \frac{1 - 2\nu}{1 - \nu}. \quad (3.220)$$

This factor varies between 0 (for $\nu = \frac{1}{2}$) and 1 (for $\nu = 0$).

Figure 3.12 shows the stresses as a function of R/a , for the case $\nu = 0$.

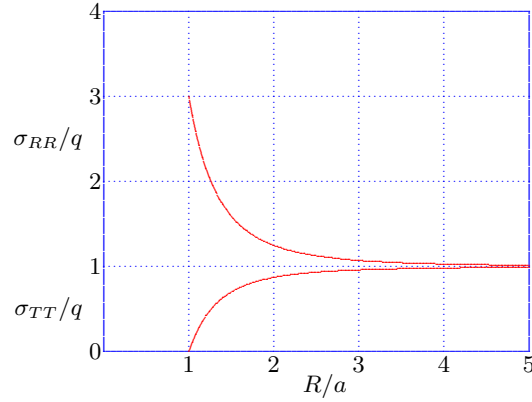

Figure 3.12: Elastic stresses around spherical inclusion, $\nu = 0$.

3.5.3 Poroelastic problems

The basic equations for spherical symmetric poroelasticity have already been given in the analysis of Cryer's problem, see section 3.3. For convenience of reference they are repeated here.

The first basic equation is the continuity equation of the pore fluid,

$$\alpha \frac{\partial \varepsilon}{\partial t} + S \frac{\partial p}{\partial t} = \frac{k}{\gamma_f} \left(\frac{\partial^2 p}{\partial R^2} + \frac{2}{R} \frac{\partial p}{\partial R} \right) = \frac{k}{\gamma_f} \frac{1}{R} \frac{\partial^2 (pR)}{\partial R^2}, \quad (3.221)$$

where ε is the volume strain, p is the excess pore pressure, α is Biot's coefficient, k is the coefficient of permeability, γ_f is the volumetric weight of the pore fluid, and S is the storage coefficient, defined as

$$S = nC_f + (\alpha - n)C_s. \quad (3.222)$$

Here n is the porosity, C_f is the compressibility of the fluid, and C_s is the compressibility of the solid particles. In the case of incompressible constituents $S = 0$ and $\alpha = 1$.

The volume strain ε is related to the radial displacement u by

$$\varepsilon = \frac{\partial u}{\partial R} + \frac{2u}{R} = \frac{1}{R^2} \frac{\partial (uR^2)}{\partial R}. \quad (3.223)$$

The second basic equation is the equation of radial equilibrium, which can be expressed as

$$\frac{\partial \sigma_{RR}}{\partial R} + 2 \frac{\sigma_{RR} - \sigma_{TT}}{R} = 0, \quad (3.224)$$

where σ_{RR} and σ_{TT} are the total stresses in radial and tangential direction. The total stresses can be separated into the effective stresses and the pore pressure by the equations

$$\sigma_{RR} = \sigma'_{RR} + \alpha p, \quad \sigma_{TT} = \sigma'_{TT} + \alpha p. \quad (3.225)$$

Using these relations the equation of equilibrium can be written as

$$\frac{\partial \sigma'_{RR}}{\partial R} + 2 \frac{\sigma'_{RR} - \sigma'_{TT}}{R} + \alpha \frac{\partial p}{\partial R} = 0. \quad (3.226)$$

Using equation (3.223) and the stress-strain-relations

$$\sigma'_{RR} = -(K - \frac{2}{3}G)\varepsilon - 2G \frac{\partial u}{\partial R}, \quad \sigma'_{TT} = -(K - \frac{2}{3}G)\varepsilon - 2G \frac{u}{R}, \quad (3.227)$$

the equation of equilibrium can be expressed in terms of the volume strain as

$$(K + \frac{4}{3}G) \frac{\partial \varepsilon}{\partial R} = \alpha \frac{\partial p}{\partial R}. \quad (3.228)$$

In these equations K is the compression modulus of the porous medium in fully drained conditions, and G is its shear modulus.

3.5.4 A sink in an infinite poroelastic medium

As an example the consolidation around a point sink in a poroelastic medium of infinite extent is considered. The problem can most conveniently be solved using Laplace transforms. The Laplace transforms of the two basic equations (3.221) and (3.228) are

$$\alpha s \bar{\varepsilon} + S s \bar{p} = \frac{k}{\gamma_f} \frac{1}{R} \frac{d^2(\bar{p}R)}{dR^2}, \quad (3.229)$$

$$\left(K + \frac{4}{3}G\right) \frac{d\bar{\varepsilon}}{dR} = \alpha \frac{d\bar{p}}{dR}. \quad (3.230)$$

Integration of equation (3.230) gives

$$\left(K + \frac{4}{3}G\right) \bar{\varepsilon} = \alpha \bar{p}, \quad (3.231)$$

where an integration constant has been omitted, assuming that both quantities vanish at infinity.

Elimination of $\bar{\varepsilon}$ from the two equations (3.229) and (3.231) now gives

$$\frac{d^2(\bar{p}R)}{dR^2} = \frac{s}{c_v} \bar{p}R, \quad (3.232)$$

where c_v is the consolidation coefficient

$$c_v = \frac{k(K + \frac{4}{3}G)}{\gamma_f[\alpha^2 + S(K + \frac{4}{3}G)]}. \quad (3.233)$$

The solution of the differential equation (3.232) vanishing at infinity is

$$\bar{p}R = A \exp(-R\sqrt{s/c_v}), \quad (3.234)$$

where A is an integration constant.

In this case the boundary conditions are

$$R = 0 : 4\pi R^2 \frac{k}{\gamma_f} \frac{\partial p}{\partial R} = QH(t), \quad (3.235)$$

$$R = 0 : u \neq \infty, \quad (3.236)$$

$$R \rightarrow \infty : p = 0, \quad (3.237)$$

$$R \rightarrow \infty : \sigma_{RR} = 0. \quad (3.238)$$

In equation (3.235) Q is the discharge of the sink, and $H(t)$ is the unit step function, indicating that the sink starts to produce water at time $t = 0$, and remains pumping at a constant rate. The initial condition is that the stresses and the displacements are zero at time $t = 0$.

It follows from the first boundary condition, equation (3.235), that the Laplace transform of the pore pressure is

$$\bar{p} = -\frac{Q\gamma_f}{4\pi kR} \frac{\exp(-R\sqrt{s/c_v})}{s}, \quad (3.239)$$

and its inverse transform, which can be found in a table of Laplace transforms, e.g. Churchill (1972), is

$$p = -\frac{Q\gamma_f}{4\pi kR} \operatorname{erfc}(\sqrt{R^2/4c_v t}), \quad (3.240)$$

where $\operatorname{erfc}(z)$ is the complementary error function, see Abramowitz & Stegun (1964),

$$\operatorname{erfc}(z) = \frac{2}{\sqrt{\pi}} \int_z^\infty \exp(-t^2) dt. \quad (3.241)$$

Because $\operatorname{erfc}(0) = 1$ the steady state limit is

$$t \rightarrow \infty : p = -\frac{Q\gamma_f}{4\pi kR}. \quad (3.242)$$

This is in agreement with the well known steady state solution for a point sink in an infinite porous medium, which can easily be derived from Darcy's law and the continuity equation.

The Laplace transform of the volume strain is, with equation (3.231),

$$\bar{\varepsilon} = -\frac{\alpha Q}{4\pi c_v R} \frac{\exp(-R\sqrt{s/c_v})}{s}, \quad (3.243)$$

where c_v is the classical consolidation coefficient, for incompressible constituents,

$$c_v = \frac{k(K + \frac{4}{3}G)}{\gamma_f}. \quad (3.244)$$

Inverse transformation of equation (3.243) gives

$$\varepsilon = -\frac{\alpha Q}{4\pi c_v R} \operatorname{erfc}(\sqrt{R^2/4c_v t}). \quad (3.245)$$

The relation between the Laplace transforms of the volume strain and the radial displacement is, with equation (3.223),

$$\frac{d(\bar{u}R^2)}{dR} = \bar{\varepsilon}R^2 = -\frac{\alpha QR}{4\pi c} \frac{\exp(-R\sqrt{s/c_v})}{s}. \quad (3.246)$$

Integration of this equation leads to the Laplace transform of the radial displacement,

$$\bar{u} = -\frac{\alpha Q c_v}{4\pi c_v R^2} \frac{1 - (1 + R\sqrt{s/c_v}) \exp(-R\sqrt{s/c_v})}{s^2}, \quad (3.247)$$

where the integration constant has been assumed to be such that the singularity at the origin $R = 0$ is eliminated.

The inverse Laplace transformation is, using the tables collected by Bateman (1954),

$$u = -\frac{\alpha Q}{4\pi c_v} \left\{ \frac{c_v t}{R^2} \operatorname{erf}(\sqrt{R^2/4c_v t}) + \frac{1}{2} \operatorname{erfc}(\sqrt{R^2/4c_v t}) - \sqrt{c_v t/\pi R^2} \exp(-R^2/4c_v t) \right\}. \quad (3.248)$$

Because for small values of x the functions in this expression can be approximated by $\operatorname{erf}(x) \approx 2x/\sqrt{\pi}$, $\operatorname{erfc}(x) \approx 1$ and $\exp(-x) \approx 1$, the steady state solution is found to be

$$t \rightarrow \infty : u = -\frac{\alpha Q}{8\pi c_v}, \quad (3.249)$$

which is in agreement with the known steady state solution for a point sink in an infinite porous medium (Booker & Carter, 1986). It may be noted that this steady state solution can also be obtained directly from the Laplace transform (3.247) using the theorem (Carslaw & Jaeger, 1948) that

$$\lim_{t \rightarrow \infty} u = \lim_{s \rightarrow 0} s\bar{u}. \quad (3.250)$$

The Laplace transform of the radial total stress is

$$\bar{\sigma}_{RR} = -\frac{\alpha G Q}{\pi R^3} \left\{ \frac{1 - \exp(-R\sqrt{s/c_v})}{s^2} - \frac{R}{\sqrt{c_v}} \frac{\exp(-R\sqrt{s/c_v})}{s^{3/2}} \right\}, \quad (3.251)$$

and its inverse transformation is

$$\sigma_{RR} = -\frac{\alpha G Q}{\pi c_v R} \left\{ \frac{c_v t}{R^2} \operatorname{erf}(\sqrt{R^2/4c_v t}) + \frac{1}{2} \operatorname{erfc}(\sqrt{R^2/4c_v t}) - \frac{\sqrt{c_v t}}{\sqrt{\pi R^2}} \exp(-R^2/4c_v t) \right\}. \quad (3.252)$$

From this expression the steady state solution is found to be

$$t \rightarrow \infty : \sigma_{RR} = -\frac{\alpha G Q}{2\pi c_v R}. \quad (3.253)$$

The Laplace transform of the tangential total stress is

$$\bar{\sigma}_{TT} = \frac{\alpha G Q}{2\pi R^3} \left\{ \frac{1 - \exp(-R\sqrt{s/c_v})}{s^2} - \frac{R}{\sqrt{c_v}} \frac{\exp(-R\sqrt{s/c_v})}{s^{3/2}} - \frac{R^2}{c_v} \frac{\exp(-R\sqrt{s/c_v})}{s} \right\}. \quad (3.254)$$

and its inverse transformation is

$$\sigma_{TT} = \frac{\alpha G Q}{2\pi c_v R} \left\{ \frac{c_v t}{R^2} \operatorname{erf}(\sqrt{R^2/4c_v t}) - \frac{1}{2} \operatorname{erfc}(\sqrt{R^2/4c_v t}) - \frac{\sqrt{c_v t}}{\sqrt{\pi} R^2} \exp(-R^2/4c_v t) \right\}. \quad (3.255)$$

From this expression the steady state solution is found to be

$$t \rightarrow \infty : \sigma_{TT} = -\frac{\alpha G Q}{4\pi c_v R}. \quad (3.256)$$

3.5.5 Improvement of the solution

The solution given in the previous section has the inconvenient property that in the steady state (for $t \rightarrow \infty$) the radial displacement is constant, also in the origin $R = 0$. An improved solution can be obtained by a modification of the boundary conditions, which now are assumed to be

$$R \rightarrow 0 : 4\pi R^2 \frac{k}{\gamma_f} \frac{\partial p}{\partial R} = QH(t), \quad (3.257)$$

$$R = a : u = 0, \quad (3.258)$$

$$R \rightarrow \infty : p = 0, \quad (3.259)$$

$$R \rightarrow \infty : \sigma_{RR} = 0. \quad (3.260)$$

In equation (3.258) a is the (small) radius of a rigid spherical inclusion.

It follows from the first boundary condition, equation (3.257), that the Laplace transform of the pore pressure is

$$\bar{p} = -\frac{Q\gamma_f}{4\pi k R} \frac{\exp(-R\sqrt{s/c_v})}{s}, \quad (3.261)$$

and its inverse transform, which can be found in a table of Laplace transforms, e.g. Churchill (1972), is

$$p = -\frac{Q\gamma_f}{4\pi k R} \operatorname{erfc}(\sqrt{R^2/4c_v t}), \quad (3.262)$$

where $\operatorname{erfc}(z)$ is the complementary error function, see Abramowitz & Stegun (1964),

$$\operatorname{erfc}(z) = \frac{2}{\sqrt{\pi}} \int_z^\infty \exp(-t^2) dt. \quad (3.263)$$

Because $\operatorname{erfc}(0) = 1$ the steady state limit is

$$t \rightarrow \infty : p = -\frac{Q\gamma_f}{4\pi k R}. \quad (3.264)$$

It may be noted that this is the same expression as obtained before in the previous section, see equation (3.242).

The Laplace transform of the volume strain is, with equation (3.231),

$$\bar{\varepsilon} = -\frac{\alpha Q}{4\pi c_v R} \frac{\exp(-R\sqrt{s/c_v})}{s}, \quad (3.265)$$

where c_v is the classical consolidation coefficient, for incompressible constituents,

$$c_v = \frac{k(K + \frac{4}{3}G)}{\gamma_f}. \quad (3.266)$$

Inverse transformation of equation (3.265) gives

$$\varepsilon = -\frac{\alpha Q}{4\pi c_v R} \operatorname{erfc}(\sqrt{R^2/4c_v t}). \quad (3.267)$$

The relation between the Laplace transforms of the volume strain and the radial displacement is, with equation (3.223),

$$\frac{d(\bar{u}R^2)}{dR} = \bar{\varepsilon}R^2 = -\frac{\alpha QR}{4\pi c_v} \frac{\exp(-R\sqrt{s/c_v})}{s}. \quad (3.268)$$

Integration of this equation leads to the Laplace transform of the radial displacement,

$$\bar{u} = -\frac{\alpha Q}{4\pi R^2} \frac{(1 + a\sqrt{s/c_v}) \exp(-a\sqrt{s/c_v}) - (1 + R\sqrt{s/c_v}) \exp(-R\sqrt{s/c_v})}{s^2}, \quad (3.269)$$

where the integration constant has been determined so that the boundary condition (3.258) is satisfied. It may be noted that this expression differs from the result in the previous solution.

The inverse Laplace transformation is, using the tables by Erdélyi *et al.* (1954),

$$u = \frac{\alpha Q}{4\pi c_v} \left\{ \frac{c_v t}{R^2} [\operatorname{erf} \sqrt{a^2/4c_v t} - \operatorname{erf} \sqrt{R^2/4c_v t}] - \frac{1}{2} [\operatorname{erfc} \sqrt{R^2/4c_v t} - (a^2/R^2) \operatorname{erfc} \sqrt{a^2/4c_v t}] + \sqrt{c_v t/\pi R^2} [\exp(-R^2/4c_v t) - (a/R) \exp(-a^2/4c_v t)] \right\}. \quad (3.270)$$

The steady state solution can be obtained by letting $t \rightarrow \infty$ or $1/t \rightarrow 0$. This gives, because for small values of x : $\operatorname{erf}(x) \approx 2x/\sqrt{\pi}$, and $\exp(-x) \approx 1$,

$$t \rightarrow \infty : u = u_\infty (1 - a^2/R^2), \quad (3.271)$$

where

$$u_\infty = -\frac{\alpha Q}{8\pi c_v}. \quad (3.272)$$

It may be verified that this steady state solution can also be obtained directly from the Laplace transform (3.269) using the theorem (Carslaw & Jaeger, 1948) that

$$\lim_{t \rightarrow \infty} u = \lim_{s \rightarrow 0} s\bar{u}. \quad (3.273)$$

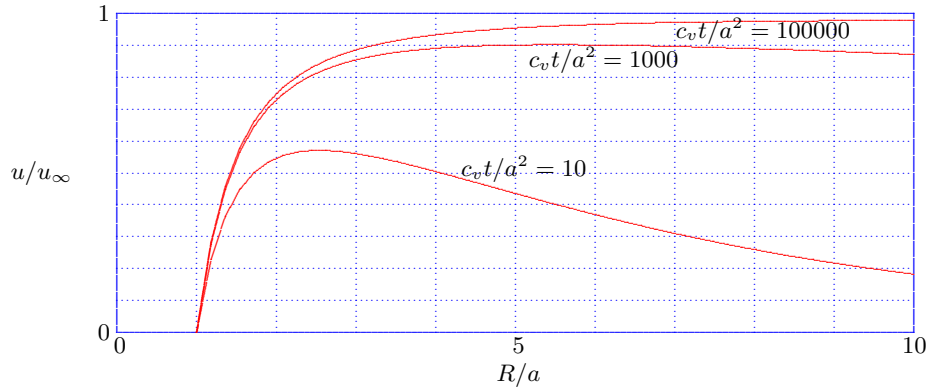

Figure 3.13: Sink in infinite spherical medium, radial displacements.

Figure 3.13 shows the radial displacement as a function of R/a , for three values of the time parameter $c_v t/a^2$. It can be seen that for very large values of t the results tend towards the steady state value.

The Laplace transform of the radial total stress is

$$\bar{\sigma}_{RR} = -(K - \frac{2}{3}G)\bar{\varepsilon} - 2G \frac{d\bar{u}}{dR} + \alpha \bar{p}, \quad (3.274)$$

or, with equation (3.231),

$$\bar{\sigma}_{RR} = 2G\bar{\varepsilon} - 2G\frac{d\bar{u}}{dR} = \frac{4G\bar{u}}{R}. \quad (3.275)$$

The Laplace transform of the tangential total stress is

$$\bar{\sigma}_{TT} = -(K - \frac{2}{3}G)\bar{\varepsilon} - 2G\frac{d\bar{u}}{dR} + \alpha\bar{p}, \quad (3.276)$$

or, with equation (3.231),

$$\bar{\sigma}_{TT} = 2G\bar{\varepsilon} - \frac{2G\bar{u}}{R}. \quad (3.277)$$

The inverse transforms of the radial total stress and the tangential total stress can immediately be obtained from the expressions given for the volume strain ε and the radial displacement u .

3.6 De Josselin de Jong's problem

Problems for a spherical inclusion (or a cavity) in an infinite field were studied by De Josselin de Jong (1957) and Rice *et al.* (1978). In this section an elementary example is considered, for a rigid spherical inclusion in an infinite porous medium with incompressible constituents (fluid and particles).

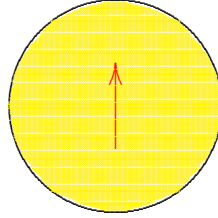

Figure 3.14: Vertical force on sphere.

It is assumed that a vertical force is applied to the spherical inclusion, see Figure 3.14, probably generating pore pressures in the porous medium, and displacements of the sphere, with the pore pressures gradually decreasing while the force remains constant, and increasing the displacements. The final value of the vertical displacement, when the pore pressures have been dissipated, can be determined from the elastic solution, which is a classical problem, on the basis of Kelvin's problem (Love, 1944). The initial displacement can be determined using an undrained analysis.

3.6.1 Axially symmetric elasticity

The two differential equations of equilibrium are

$$\frac{\partial\sigma_{rr}}{\partial r} + \frac{\sigma_{rr} - \sigma_{tt}}{r} + \frac{\sigma_{rz}}{\partial z} = 0, \quad (3.278)$$

$$\frac{\partial\sigma_{zz}}{\partial z} + \frac{\partial\sigma_{rz}}{\partial r} + \frac{\sigma_{rz}}{r} = 0. \quad (3.279)$$

The strains can be expressed into the two displacement components u_r and u_z by the equations

$$\varepsilon_{rr} = \frac{\partial u_r}{\partial r}, \quad (3.280)$$

$$\varepsilon_{tt} = \frac{u_r}{r}, \quad (3.281)$$

$$\varepsilon_{zz} = \frac{\partial u_z}{\partial z}, \quad (3.282)$$

$$\varepsilon_{rz} = \frac{1}{2}\left(\frac{\partial u_r}{\partial z} + \frac{\partial u_z}{\partial r}\right). \quad (3.283)$$

$$\varepsilon_{rt} = 0, \quad (3.284)$$

$$\varepsilon_{zt} = 0. \quad (3.285)$$

With Hooke's law for an isotropic material the stresses can be expressed into the strains and the displacements by the equations

$$\sigma_{rr} = -2\mu\varepsilon_{rr} - \lambda\varepsilon, \quad (3.286)$$

$$\sigma_{tt} = -2\mu\varepsilon_{tt} - \lambda\varepsilon, \quad (3.287)$$

$$\sigma_{zz} = -2\mu\varepsilon_{zz} - \lambda\varepsilon, \quad (3.288)$$

$$\sigma_{rz} = -2\mu\varepsilon_{rz}, \quad (3.289)$$

$$\sigma_{rt} = -2\mu\varepsilon_{rt}, \quad (3.290)$$

$$\sigma_{zt} = -2\mu\varepsilon_{zt}, \quad (3.291)$$

where ε is the volume strain,

$$\varepsilon = \varepsilon_{rr} + \varepsilon_{tt} + \varepsilon_{zz} = \frac{\partial u_r}{\partial r} + \frac{u_r}{r} + \frac{\partial u_z}{\partial z}. \quad (3.292)$$

In these equations the sign convention of soil mechanics is used, with compressive stresses being considered positive.

The stresses can also be expressed directly into the displacements,

$$\sigma_{rr} = -\lambda\varepsilon - 2\mu\frac{\partial u_r}{\partial r}, \quad (3.293)$$

$$\sigma_{tt} = -\lambda\varepsilon - 2\mu\frac{u_r}{r}, \quad (3.294)$$

$$\sigma_{zz} = -\lambda\varepsilon - 2\mu\frac{\partial u_z}{\partial z}, \quad (3.295)$$

$$\sigma_{rz} = -\mu\left(\frac{\partial u_r}{\partial z} - \frac{\partial u_z}{\partial r}\right), \quad (3.296)$$

$$\sigma_{rt} = 0, \quad (3.297)$$

$$\sigma_{zt} = 0. \quad (3.298)$$

It has been found by Love (1944) that the basic equations of equilibrium can be satisfied by expressing the displacements into a function ϕ by the equations

$$2\mu u_r = -\frac{\partial^2 \phi}{\partial r \partial z}, \quad (3.299)$$

$$2\mu u_z = -\frac{\partial^2 \phi}{\partial z^2} + 2(1 - \nu)\nabla^2 \phi, \quad (3.300)$$

where

$$\nabla^2 \phi = \frac{\partial^2 \phi}{\partial r^2} + \frac{1}{r} \frac{\partial \phi}{\partial r} + \frac{\partial^2 \phi}{\partial z^2}. \quad (3.301)$$

The volume strain now can be expressed as

$$2\mu\varepsilon = (1 - 2\nu)\frac{\partial}{\partial z}\nabla^2 \phi. \quad (3.302)$$

And the stresses can be expressed into the function ϕ by the equations

$$\sigma_{rr} = -\frac{\partial}{\partial z}\left(\nu\nabla^2 \phi - \frac{\partial^2 \phi}{\partial r^2}\right), \quad (3.303)$$

$$\sigma_{tt} = -\frac{\partial}{\partial z}\left(\nu\nabla^2 \phi - \frac{1}{r}\frac{\partial \phi}{\partial r}\right), \quad (3.304)$$

$$\sigma_{zz} = -\frac{\partial}{\partial z}[(2-\nu)\nabla^2\phi - \frac{\partial^2\phi}{\partial z^2}], \quad (3.305)$$

$$\sigma_{rz} = -\frac{\partial}{\partial r}[(1-\nu)\nabla^2\phi - \frac{\partial^2\phi}{\partial z^2}]. \quad (3.306)$$

It can be verified that the equations of equilibrium are now satisfied, provided that the function ϕ satisfies the biharmonic equation

$$\nabla^2\nabla^2\phi = 0. \quad (3.307)$$

The solution of a particular problem can be constructed by searching among functions satisfying equation (3.307), investigating their properties, and trying to find a suitable combination of solutions.

3.6.2 Kelvin's solution

An elementary solution is due to Kelvin, for a concentrated force at the interior of an infinite solid (Timoshenko & Goodier, 1970; Selvadurai, 2000; Sadd, 2005). This solution is of the form

$$\phi = AR = A\sqrt{r^2 + z^2} = A(r^2 + z^2)^{1/2}, \quad (3.308)$$

where A is a constant to be determined later.

It follows that the two displacements now are

$$2\mu u_r = A\frac{rz}{R^3}, \quad (3.309)$$

$$2\mu u_z = A[(3-4\nu)\frac{1}{R} + \frac{z^2}{R^3}]. \quad (3.310)$$

And the stresses are

$$\sigma_{rr} = -A(1-2\nu)\frac{z}{R^3} + A\frac{3r^2z}{R^5}, \quad (3.311)$$

$$\sigma_{tt} = -A(1-2\nu)\frac{z}{R^3}, \quad (3.312)$$

$$\sigma_{zz} = A(1-2\nu)\frac{z}{R^3} + A\frac{3z^3}{R^5}, \quad (3.313)$$

$$\sigma_{rz} = A(1-2\nu)\frac{r}{R^3} + A\frac{3rz^2}{R^5}. \quad (3.314)$$

The total force can be determined, following Timoshenko & Goodier (1970), by considering a small spherical

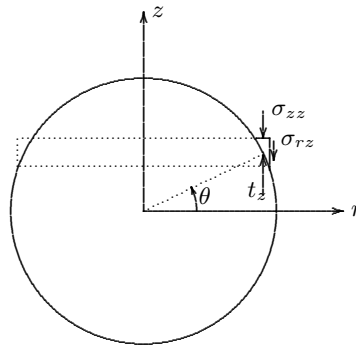

Figure 3.15: Kelvin's problem

cavity around the origin, first calculating the vertical force on a ring-shaped element, see Figure 3.15, and then integrating over the entire sphere. The magnitude of the local surface traction t_z can be expressed into the stress components along the circular arc by the relation

$$t_z = \sigma_{zz} \sin \theta + \sigma_{rz} \cos \theta = \sigma_{zz}z/R + \sigma_{rz}r/R. \quad (3.315)$$

This gives

$$t_z = A(1 - 2\nu) \frac{1}{R^2} + A \frac{3z^2}{R^4} = A(1 - 2\nu) \frac{1}{R^2} + A \frac{3 \sin^2 \theta}{R^2}. \quad (3.316)$$

Because the area of the ring is $2\pi r R d\theta$, it follows that the total vertical force on the material outside the sphere is

$$P = 2\pi A \int_{-\pi/2}^{+\pi/2} (1 - 2\nu) \cos \theta d\theta + 2\pi A \int_{-\pi/2}^{+\pi/2} 3 \sin^2 \theta d \sin \theta = 8\pi A(1 - \nu). \quad (3.317)$$

It follows that

$$A = \frac{P}{8\pi(1 - \nu)} \quad (3.318)$$

This completes the solution of the first part of the problem.

The displacements are, with equations (3.309) and (3.310),

$$2\mu u_r = \frac{Prz}{8\pi(1 - \nu)R^3}, \quad (3.319)$$

$$2\mu u_z = \frac{P[(3 - 4\nu)R^2 + z^2]}{8\pi(1 - \nu)R^3}. \quad (3.320)$$

These displacements are not constant along the circumference of the sphere, and therefore cannot represent the solution of a rigid spherical inclusion. This can be repaired by adding the following solution.

3.6.3 Kelvin's solution, concluded

An additional solution is the harmonic function

$$\phi = \frac{B}{R} = \frac{B}{\sqrt{r^2 + z^2}}. \quad (3.321)$$

For this solution the displacements are

$$2\mu u_r = -B \frac{3rz}{R^5}, \quad (3.322)$$

$$2\mu u_z = B \frac{1}{R^3} - B \frac{3z^2}{R^5}. \quad (3.323)$$

And the stresses are

$$\sigma_{rr} = B \frac{3z}{R^5} - B \frac{15r^2 z}{R^7}, \quad (3.324)$$

$$\sigma_{tt} = B \frac{3z}{R^5}, \quad (3.325)$$

$$\sigma_{zz} = B \frac{9z}{R^5} - B \frac{15z^3}{R^7}, \quad (3.326)$$

$$\sigma_{rz} = B \frac{3r}{R^5} - B \frac{15rz^2}{R^7}. \quad (3.327)$$

The traction on an element of a ring, as shown in Figure 3.15, in this case is

$$t_z = \sigma_{zz} \frac{z}{R} \sigma_{rz} \frac{r}{R} = 3B \frac{1}{R^3} - 9B \frac{\sin^2 \theta}{R^3}. \quad (3.328)$$

The total force on a sphere with radius R is

$$P = \frac{2\pi}{R} \int_{-\pi/2}^{+\pi/2} 3B \cos \theta d\theta - \frac{2\pi}{R} \int_{-\pi/2}^{+\pi/2} 9B \sin^2 \theta d \sin \theta = 0. \quad (3.329)$$

The total force in this solution appears to be zero.

3.6.4 Rigid spherical inclusion

The two solutions can be combined to produce the case of a rigid inclusion. The radial displacements will be zero if $B = AR_0^2/3$, where R_0 is a given length, the radius of the inclusion. The total solution then is

$$\phi = AR + A\frac{R_0^2}{3R}. \quad (3.330)$$

The displacements now are

$$2\mu u_r = A\frac{rz}{R^3} - A\frac{rzR_0^2}{R^5}, \quad (3.331)$$

$$2\mu u_z = A(3 - 4\nu)\frac{1}{R} + \frac{z^2}{R} + A\frac{R_0^2}{3R^3} - A\frac{R_0^2 z^2}{R^5}. \quad (3.332)$$

For $R = R_0$ these displacements are

$$R = R_0 : 2\mu u_r = 0, \quad (3.333)$$

$$R = R_0 : 2\mu u_z = A\frac{10 - 12\nu}{3R_0}. \quad (3.334)$$

It appears that for this combined solution the radial displacement is zero, and that the vertical displacement is constant. This indicates that this solution can indeed be used for the case of a vertical force on a rigid spherical inclusion of radius R_0 . Because the second part of the solution does not contribute to the total force, this force is, as in equation (3.318),

$$P = 8\pi A(1 - \nu). \quad (3.335)$$

It now follows that the vertical displacement of the inclusion is

$$2\mu u_z = \frac{P}{12\pi R_0} \frac{5 - 6\nu}{1 - \nu}. \quad (3.336)$$

For $\nu = 0$ the factor $(5 - 6\nu)/(1 - \nu) = 5$, and for $\nu = 0.5$ this factor is $(5 - 6\nu)/(1 - \nu) = 4$. It appears that the displacement for the minimum value of ν is a factor 5/4 larger than the value for the maximum value of ν , which applies to an incompressible elastic medium. This result is in agreement with results given by De Josselin de Jong (1957). The vertical displacement of the inclusion is shown, for two types of boundary

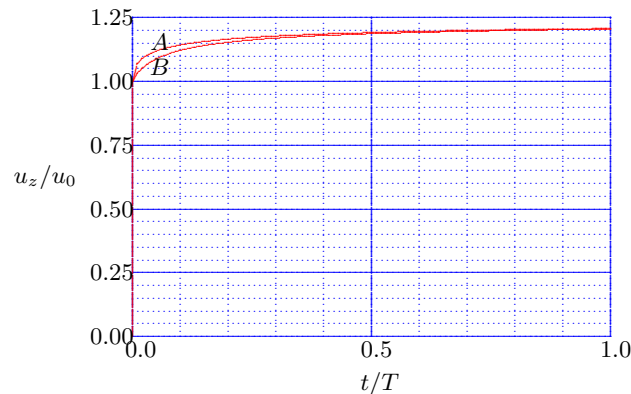

Figure 3.16: Vertical displacement of rigid inclusion, $T=10$.

condition for the pore pressure, zero pore pressure (A) and impermeable boundary (B), in Figure 3.16. The curves have been determined using the Talbot method for the inverse Laplace transforms.

It follows from this analysis that for a porous medium, saturated with an incompressible fluid, and consisting of incompressible particles, the initial displacement is the value obtained for $\nu = 0.5$. If the drained value of Poisson's ratio is $\nu = 0$, the smallest possible value, the final displacement is only 20 % more than the initial value. This means that the consolidation process for this problem is of minor importance.

3.6.5 The pore pressure distribution

The initial distribution of the pore pressures, at the time of loading by the vertical force P , can be determined using the third of equations (1.59), giving the pore pressure in undrained conditions,

$$t = 0 : p_0 = \frac{\alpha\sigma_0}{\alpha^2 + KS},$$

where in this case $\alpha = 1$ and $S = 0$, because it has been assumed that the fluid and the particles are incompressible. This gives

$$t = 0 : p_0 = \sigma_0. \quad (3.337)$$

For the first part of the solution of the problem considered in this section the isotropic stress is

$$\sigma_0 = \frac{2}{3}A(1 + \nu)\frac{z}{R^3} = A\frac{z}{R^3}, \quad (3.338)$$

where Poisson's ratio has been taken as $\nu = 0.5$ for this undrained situation.

For the second part of the solution the isotropic stress is $\sigma_0 = 0$, so that equation (3.338) gives the isotropic stress for the case of a rigid spherical inclusion. With equation (3.318) the isotropic stress can be expressed into the force P , and with equation (3.337) this gives the initial pore pressure distribution in the form

$$t = 0 : p_0 = \frac{P}{4\pi R_0^3} \frac{z}{R_0}, \quad (3.339)$$

where again it has been assumed that $\nu = 0.5$ because of the undrained condition.

It may be noted that the maximum value of this pore pressure at the surface of the spherical inclusion occurs for $z = R = R_0$,

$$p_m = \frac{P}{4\pi R_0^2}. \quad (3.340)$$

This means that equation (3.339) can be written in dimensionless form as

$$t = 0 : \frac{p_0}{p_m} = \frac{zR_0^2}{(r^2 + z^2)^{3/2}}. \quad (3.341)$$

The maximum value of p_0/p_m is 1, occurring for $r = 0$, $z = R_0$, and the minimum value is -1, occurring for $r = 0$, $z = -R_0$. The values of the dimensionless pore pressure can easily be calculated in the points of a mesh as shown in Figure 3.17.

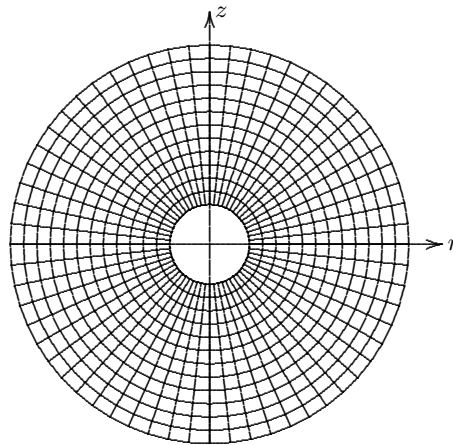

Figure 3.17: Spherical inclusion, mesh of calculation points.

From the mesh of values contours of the pore pressure can be calculated by a simple algorithm. The results are shown in Figure 3.18. For clarity of the figure the mesh is not shown.

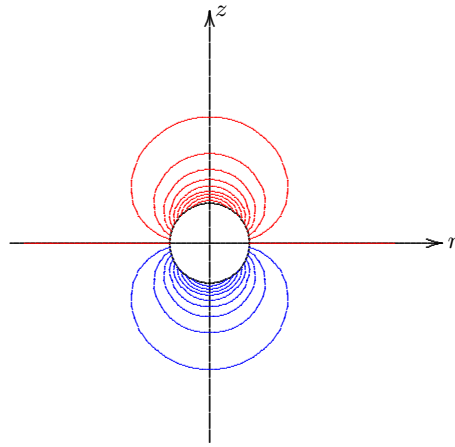

Figure 3.18: Spherical inclusion, contours of initial pore pressure.

3.7 A problem of Booker and Carter

This section presents the solution of the problem of a point sink in a consolidating half space, see Figure 3.19. The surface $z = 0$ is free of total stress and fully drained, so that the pore pressures on it remain zero. Problems of this type were first considered and solved by Booker & Carter (1986, 1987), both for the steady and the non-steady case, with the non-steady case including the time-dependent behaviour due to consolidation. The non-steady problem has also been considered by Chau (1996), for the case of a porous medium with

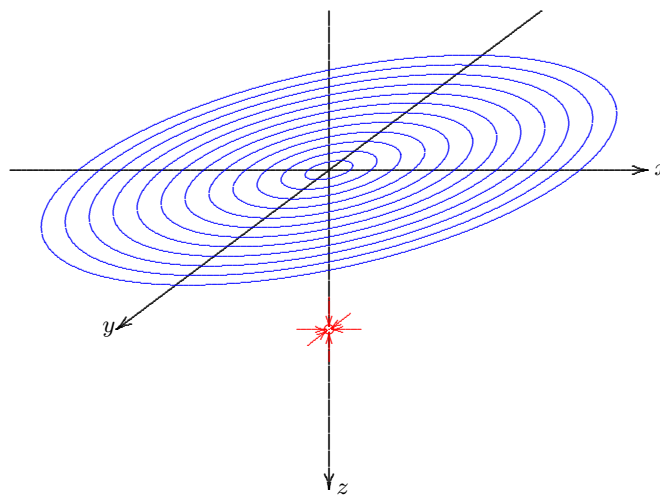

Figure 3.19: Point sink in half space.

incompressible constituents, and using a less accurate numerical inversion method (Schapery, 1962) than Talbot's method (Talbot, 1979), which is used here, and which was also used by Booker & Carter (1986). For the uncoupled case, in which the flow field is independent of the displacement field, analytical solutions for the surface displacements due to an impulsive sink were obtained by Lin & Lu (2010). A variant of the problem was considered by Barends (1981), for the case of a sink in a half plane with an impermeable upper boundary.

In the present section the problem of a drained half space will be extended to somewhat more general soil properties, including compressible solid particles and pore fluid, see also Verruijt (2008). It should be noted that both in the works of Booker & Carter (1986) and in this section, the displacement field and the flow field are fully coupled. The solution uses integral transforms (Laplace and Hankel), and numerical integration of the inverse Hankel transforms and Talbot's method for the numerical inverse Laplace transforms.

The problem will be solved by a superposition of three solutions: a sink at a depth h below the free surface $z = 0$, an imaginary source at a distance h above the free surface, see Figure 3.20, and an additional solution of a Boussinesq type problem in order to satisfy the boundary condition at the free surface that the shear

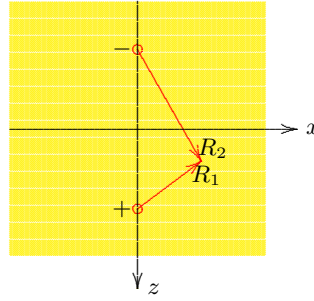

Figure 3.20: Two symmetric singularities of opposite strength.

stress is zero. It can be expected that the source and the sink, being of opposite sign and equal strength, lead to a zero normal stress and a zero pore pressure at the surface $z = 0$, because of the symmetry. There is no need to balance the normal stresses or the pore pressure. However, an additional solution is needed to eliminate the shear stress at the free surface.

As before, compressive stresses are considered positive.

3.7.1 Solution for a single sink

The first part of the solution is the consolidation around a point sink in a poroelastic medium of infinite extent. In this case the flow and the deformation are spherically symmetric, and it is convenient to derive the solution of this basic problem using a formulation of the consolidation equations using spherical coordinates, see also sections 3.3 and 3.5.

3.7.2 Basic equations of spherically symmetric consolidation

The first basic equation of consolidation is the continuity equation of the pore fluid,

$$\alpha \frac{\partial \varepsilon}{\partial t} + S \frac{\partial p}{\partial t} = \frac{k}{\gamma_f} \left(\frac{\partial^2 p}{\partial R^2} + \frac{2}{R} \frac{\partial p}{\partial R} \right), \quad (3.342)$$

where ε is the volume strain, p is the excess pore pressure, α is Biot's coefficient, k is the coefficient of permeability, γ_f is the volumetric weight of the pore fluid, and S is the storativity, defined as

$$S = nC_f + (\alpha - n)C_s. \quad (3.343)$$

Here n is the porosity, C_f is the compressibility of the fluid, and C_s is the compressibility of the solid particles. In the case of incompressible constituents $S = 0$ and $\alpha = 1$.

The volume strain ε is related to the radial displacement u by

$$\varepsilon = \frac{\partial u}{\partial R} + \frac{2u}{R}. \quad (3.344)$$

The second basic equation is the equation of radial equilibrium, which can be expressed as

$$\frac{\partial \sigma_{RR}}{\partial R} + 2 \frac{\sigma_{RR} - \sigma_{TT}}{R} = 0, \quad (3.345)$$

where σ_{RR} and σ_{TT} are the total stresses in radial and tangential direction. The total stresses can be separated into the effective stresses and the pore pressure by the equations

$$\sigma_{RR} = \sigma'_{RR} + \alpha p, \quad \sigma_{TT} = \sigma'_{TT} + \alpha p. \quad (3.346)$$

Using these relations the equation of equilibrium can be written as

$$\frac{\partial \sigma'_{RR}}{\partial R} + 2 \frac{\sigma'_{RR} - \sigma'_{TT}}{R} + \alpha \frac{\partial p}{\partial R} = 0. \quad (3.347)$$

Using equation (3.344) and the stress-strain-relations

$$\sigma'_{RR} = -(K - \frac{2}{3}G)\varepsilon - 2G\frac{\partial u}{\partial R}, \quad \sigma'_{TT} = -(K - \frac{2}{3}G)\varepsilon - 2G\frac{u}{R}, \quad (3.348)$$

the equation of equilibrium can be expressed in terms of the volume strain as

$$(K + \frac{4}{3}G)\frac{\partial \varepsilon}{\partial R} = \alpha\frac{\partial p}{\partial R}. \quad (3.349)$$

In these equations K is the compression modulus of the porous medium in fully drained conditions, and G is its shear modulus.

3.7.3 Boundary conditions

The problem is further defined by the boundary conditions

$$R = 0 : 4\pi R^2 \frac{k}{\gamma_f} \frac{\partial p}{\partial R} = QH(t), \quad (3.350)$$

$$R = 0 : u = 0, \quad (3.351)$$

$$R \rightarrow \infty : p = 0, \quad (3.352)$$

$$R \rightarrow \infty : \sigma_{RR} = 0. \quad (3.353)$$

In equation (3.350) Q is the discharge of the sink, and $H(t)$ is the unit step function, indicating that the sink starts to produce water at time $t = 0$, and remains pumping at a constant rate.

The initial condition is that the stresses and the displacements are zero at time $t = 0$.

3.7.4 Solution of the problem

The problem can be solved using the Laplace transformation (Churchill, 1972). The details of the analysis are not given here, as the analysis is very similar to that in the two previous sections.

The result is that the Laplace transform of the pore pressure is

$$\bar{p} = -\frac{Q\gamma_f}{4\pi kR} \frac{\exp(-R\sqrt{s/c_v})}{s}, \quad (3.354)$$

and its inverse transform, which can be found in a table of Laplace transforms, e.g. Churchill (1972), is

$$p = -\frac{Q\gamma_f}{4\pi kR} \operatorname{erfc}(\sqrt{R^2/4c_v t}), \quad (3.355)$$

where $\operatorname{erfc}(z)$ is the complementary error function, see Abramowitz & Stegun (1964),

$$\operatorname{erfc}(z) = \frac{2}{\sqrt{\pi}} \int_z^\infty \exp(-t^2) dt. \quad (3.356)$$

Because $\operatorname{erfc}(0) = 1$ the steady state limit is

$$t \rightarrow \infty : p = -\frac{Q\gamma_f}{4\pi kR}. \quad (3.357)$$

This is in agreement with the known steady state solution for a point sink in an infinite porous medium.

The Laplace transform of the volume strain is

$$\bar{\varepsilon} = -\frac{\alpha Q}{4\pi c_v R} \frac{\exp(-R\sqrt{s/c_v})}{s}, \quad (3.358)$$

where c_v is the consolidation coefficient, defined by

$$c_v = \frac{k}{\gamma_f} \frac{K + \frac{4}{3}G}{\alpha^2 + S(K + \frac{4}{3}G)}, \quad (3.359)$$

Inverse transformation of equation (3.358) gives

$$\varepsilon = -\frac{\alpha Q}{4\pi c_v R} \operatorname{erfc}(\sqrt{R^2/4c_v t}). \quad (3.360)$$

The Laplace transform of the radial displacement is found to be

$$\bar{u} = -\frac{\alpha Q}{4\pi R^2} \frac{1 - (1 + R\sqrt{s/c_v}) \exp(-R\sqrt{s/c_v})}{s^2}, \quad (3.361)$$

and its inverse transformation is

$$u = -\frac{\alpha Q}{4\pi c_v} \left\{ \frac{c_v t}{R^2} \operatorname{erf}(\sqrt{R^2/4c_v t}) + \frac{1}{2} \operatorname{erfc}(\sqrt{R^2/4c_v t}) - \sqrt{\frac{ct}{\pi R^2}} \exp(-R^2/4c_v t) \right\}. \quad (3.362)$$

Because for small values of x the functions can be approximated by $\operatorname{erf}(x) \approx 2x/\sqrt{\pi}$, $\operatorname{erfc}(x) \approx 1$ and $\exp(-x) \approx 1$, the steady state solution is found to be

$$t \rightarrow \infty : u = -\frac{\alpha Q}{8\pi c_v}, \quad (3.363)$$

which is in agreement with the known steady state solution for a point sink in an infinite porous medium. It may be noted that this steady state solution can also be obtained directly from the Laplace transform (3.361) using the theorem (Churchill, 1972)

$$\lim_{t \rightarrow \infty} u = \lim_{s \rightarrow 0} s \bar{u}. \quad (3.364)$$

The Laplace transform of the radial total stress is

$$\bar{\sigma}_{RR} = -\frac{\alpha G Q}{\pi R^3} \left\{ \frac{1 - \exp(-R\sqrt{s/c_v})}{s^2} - \frac{R}{\sqrt{c_v}} \frac{\exp(-R\sqrt{s/c_v})}{s^{3/2}} \right\}, \quad (3.365)$$

and its inverse transformation is

$$\sigma_{RR} = -\frac{\alpha G Q}{\pi c_v R} \left\{ \frac{c_v t}{R^2} \operatorname{erf}(\sqrt{R^2/4c_v t}) + \frac{1}{2} \operatorname{erfc}(\sqrt{R^2/4c_v t}) - \frac{\sqrt{c_v t}}{\sqrt{\pi R^2}} \exp(-R^2/4c_v t) \right\}. \quad (3.366)$$

From this expression the steady state solution is found to be

$$t \rightarrow \infty : \sigma_{RR} = -\frac{\alpha G Q}{2\pi c_v R}, \quad (3.367)$$

which is again in agreement with the known steady state solution.

The Laplace transform of the tangential total stress is

$$\bar{\sigma}_{TT} = \frac{\alpha G Q}{2\pi R^3} \left\{ \frac{1 - \exp(-R\sqrt{s/c_v})}{s^2} - \frac{R}{\sqrt{c_v}} \frac{\exp(-R\sqrt{s/c_v})}{s^{3/2}} - \frac{R^2}{c_v} \frac{\exp(-R\sqrt{s/c_v})}{s} \right\}. \quad (3.368)$$

and its inverse transformation is

$$\sigma_{TT} = \frac{\alpha G Q}{2\pi c_v R} \left\{ \frac{c_v t}{R^2} \operatorname{erf}(\sqrt{R^2/4c_v t}) - \frac{1}{2} \operatorname{erfc}(\sqrt{R^2/4c_v t}) - \frac{\sqrt{c_v t}}{\sqrt{\pi R^2}} \exp(-R^2/4c_v t) \right\}. \quad (3.369)$$

From this expression the steady state solution is found to be

$$t \rightarrow \infty : \sigma_{TT} = -\frac{\alpha G Q}{4\pi c_v R}, \quad (3.370)$$

also in agreement with the known steady state solution.

3.7.5 Expressions in cylindrical coordinates

It is most convenient for future analysis to express the displacement into its cylindrical components $u_r = ur/R$ and $u_z = uz/R$. With equation (3.362) these components are

$$u_r = -\frac{\alpha Q r}{4\pi c_v R} \left\{ \frac{c_v t}{R^2} \operatorname{erf}(\sqrt{R^2/4c_v t}) + \frac{1}{2} \operatorname{erfc}(\sqrt{R^2/4c_v t}) - \frac{\sqrt{c_v t}}{\sqrt{\pi R^2}} \exp(-R^2/4c_v t) \right\}, \quad (3.371)$$

$$u_z = -\frac{\alpha Q z}{4\pi c_v R} \left\{ \frac{c_v t}{R^2} \operatorname{erf}(\sqrt{R^2/4c_v t}) + \frac{1}{2} \operatorname{erfc}(\sqrt{R^2/4c_v t}) - \frac{\sqrt{c_v t}}{\sqrt{\pi R^2}} \exp(-R^2/4c_v t) \right\}. \quad (3.372)$$

Expressed as Laplace transforms these displacement components are

$$\bar{u}_r = \frac{\alpha Q r}{4\pi c_v s R} \frac{1 - (1 + \lambda R) \exp(-\lambda R)}{(\lambda R)^2}, \quad (3.373)$$

$$\bar{u}_z = \frac{\alpha Q z}{4\pi c_v s R} \frac{1 - (1 + \lambda R) \exp(-\lambda R)}{(\lambda R)^2}, \quad (3.374)$$

where, as before, $\lambda = \sqrt{s/c_v}$.

For axially symmetric deformations the relations between the effective normal stresses and the displacements are, in cylindrical coordinates,

$$\sigma'_{rr} = -(K - \frac{2}{3}G)\varepsilon - 2G \frac{\partial u_r}{\partial r}, \quad \sigma'_{tt} = -(K - \frac{2}{3}G)\varepsilon - 2G \frac{u_r}{r}, \quad \sigma'_{zz} = -(K - \frac{2}{3}G)\varepsilon - 2G \frac{\partial u_z}{\partial z}. \quad (3.375)$$

The total normal stresses are obtained by adding αp . This gives, because $\alpha p = (K + \frac{4}{3}G)\varepsilon$,

$$\sigma_{rr} = 2G \left\{ \varepsilon - \frac{\partial u_r}{\partial r} \right\}, \quad \sigma_{tt} = 2G \left\{ \varepsilon - \frac{u_r}{r} \right\}, \quad \sigma_{zz} = 2G \left\{ \varepsilon - \frac{\partial u_z}{\partial z} \right\}. \quad (3.376)$$

The shear stress is

$$\sigma_{zr} = -G \left\{ \frac{\partial u_r}{\partial z} + \frac{\partial u_z}{\partial r} \right\}. \quad (3.377)$$

The most important quantities for future analysis are the vertical normal stress σ_{zz} and the shear stress σ_{zr} . The Laplace transform of the normal stress σ_{zz} is

$$\bar{\sigma}_{zz} = \frac{G\alpha Q}{2\pi c_v s R} \left\{ \frac{1 - [1 + \lambda R + (\lambda R)^2] \exp(-\lambda R)}{(\lambda R)^2} \right\} + \frac{G\alpha Q z^2}{2\pi c_v s R^3} \left\{ \frac{3 - [3 + 3\lambda R + (\lambda R)^2] \exp(-\lambda R)}{(\lambda R)^2} \right\}, \quad (3.378)$$

and the Laplace transform of the shear stress σ_{zr} is

$$\bar{\sigma}_{zr} = -\frac{G\alpha Q r z}{2\pi c_v s R^3} \left\{ \frac{3 - [3 + 3\lambda R + (\lambda R)^2] \exp(-\lambda R)}{(\lambda R)^2} \right\}. \quad (3.379)$$

3.7.6 Solution for a sink and a source

In this section the problem of a sink and a source in a poroelastic half space will be considered, for the moment ignoring the boundary condition at the surface $z = 0$.

First part of the solution

The first part of the solution for a sink and a source of equal strength at the points $z = h$ and $z = -h$, see Figure 3.20, can be obtained by superposition of two elementary solutions, for a sink at the point $r = 0, z = h$ and a source at the point $r = 0, z = -h$. This gives

$$p = -\frac{Q\gamma_f}{4\pi k} \left\{ \frac{\operatorname{erfc}(\sqrt{R_1^2/4c_v t})}{R_1} - \frac{\operatorname{erfc}(\sqrt{R_2^2/4c_v t})}{R_2} \right\}, \quad (3.380)$$

$$u_r = -\frac{\alpha Q r}{4\pi c_v R_1} \left\{ \frac{c_v t}{R_1^2} \operatorname{erf}(\sqrt{R_1^2/4c_v t}) + \frac{1}{2} \operatorname{erfc}(\sqrt{R_1^2/4c_v t}) - \frac{\sqrt{c_v t}}{\sqrt{\pi R_1^2}} \exp(-R_1^2/4c_v t) \right\} \\ + \frac{Q r}{4\pi c_v R_2} \left\{ \frac{c_v t}{R_2^2} \operatorname{erf}(\sqrt{R_2^2/4c_v t}) + \frac{1}{2} \operatorname{erfc}(\sqrt{R_2^2/4c_v t}) - \frac{\sqrt{c_v t}}{\sqrt{\pi R_2^2}} \exp(-R_2^2/4c_v t) \right\}, \quad (3.381)$$

$$u_z = -\frac{\alpha Q(z-h)}{4\pi c_v R_1} \left\{ \frac{c_v t}{R_1^2} \operatorname{erf}(\sqrt{R_1^2/4c_v t}) + \frac{1}{2} \operatorname{erfc}(\sqrt{R_1^2/4c_v t}) - \frac{\sqrt{c_v t}}{\sqrt{\pi R_1^2}} \exp(-R_1^2/4c_v t) \right\} \\ + \frac{Q(z+h)}{4\pi c_v R_2} \left\{ \frac{c_v t}{R_2^2} \operatorname{erf}(\sqrt{R_2^2/4c_v t}) + \frac{1}{2} \operatorname{erfc}(\sqrt{R_2^2/4c_v t}) - \frac{\sqrt{c_v t}}{\sqrt{\pi R_2^2}} \exp(-R_2^2/4c_v t) \right\}. \quad (3.382)$$

where R_1 and R_2 are the distances to the sink and the source, respectively,

$$R_1 = \sqrt{r^2 + (z-h)^2}, \quad R_2 = \sqrt{r^2 + (z+h)^2}. \quad (3.383)$$

It may be noted that at the surface $z = 0$ the values of R_1 and R_2 are equal, so that

$$z = 0 : p = 0, \quad (3.384)$$

$$z = 0 : u_r = 0. \quad (3.385)$$

$$z = 0 : u_z = w_1 = \frac{\alpha Q h}{2\pi c_v a} \left\{ \frac{c_v t}{a^2} \operatorname{erf}(\sqrt{a^2/4c_v t}) + \frac{1}{2} \operatorname{erfc}(\sqrt{a^2/4c_v t}) - \frac{\sqrt{c_v t}}{\sqrt{\pi a^2}} \exp(-a^2/4c_v t) \right\}, \quad (3.386)$$

where $a = \sqrt{r^2 + h^2}$, and where the notation w_1 is used to indicate that this is only the first part of the solution. The results (3.384) and (3.385) could also have been obtained from the antisymmetry of the problem, of course.

For small values of x : $\operatorname{erf}(x) \approx 2x/\sqrt{\pi}$ and $\operatorname{erfc}(x) \approx 1$. This means that for large values of time the vertical displacement of the surface $z = 0$ is

$$z = 0, t \rightarrow \infty : u_z = w_1 = \frac{\alpha Q}{4\pi c_v} \frac{1}{\sqrt{1 + r^2/h^2}}. \quad (3.387)$$

It can also be expected that

$$z = 0 : \sigma_{zz} = 0. \quad (3.388)$$

Actually, it follows from the expression (3.378) for $\bar{\sigma}_{zz}$ in case of a single sink at the origin that for the case of a sink and a source

$$\bar{\sigma}_{zz} = \frac{\alpha G Q}{2\pi c_v s R_1} \left\{ \frac{1 - [1 + \lambda R_1 + (\lambda R_1)^2] \exp(-\lambda R_1)}{(\lambda R_1)^2} \right\} - \\ \frac{\alpha G Q}{2\pi c_v s R_2} \left\{ \frac{1 - [1 + \lambda R_2 + (\lambda R_2)^2] \exp(-\lambda R_2)}{(\lambda R_2)^2} \right\} + \\ \frac{\alpha G Q (z-h)^2}{2\pi c_v s R_1^3} \left\{ \frac{3 - [3 + 3\lambda R_1 + (\lambda R_1)^2] \exp(-\lambda R_1)}{(\lambda R_1)^2} \right\} - \\ \frac{\alpha G Q (z+h)^2}{2\pi c_v s R_2^3} \left\{ \frac{3 - [3 + 3\lambda R_2 + (\lambda R_2)^2] \exp(-\lambda R_2)}{(\lambda R_2)^2} \right\}. \quad (3.389)$$

For $z = 0$, and therefore $R_1 = R_2$, the terms cancel in pairs, so that equation (3.388) is indeed satisfied.

At the surface $z = 0$ the shear stress will not be zero, however. Actually, from equation (3.379) the Laplace transform of the shear stress for the case of a sink and a source is found to be

$$\bar{\sigma}_{zr} = -\frac{\alpha G Q r (z-h)}{2\pi c_v s R_1^3} \left\{ \frac{3 - [3 + 3\lambda R_1 + (\lambda R_1)^2] \exp(-\lambda R_1)}{(\lambda R_1)^2} \right\} + \\ + \frac{\alpha G Q r (z+h)}{2\pi c_v s R_2^3} \left\{ \frac{3 - [3 + 3\lambda R_2 + (\lambda R_2)^2] \exp(-\lambda R_2)}{(\lambda R_2)^2} \right\}. \quad (3.390)$$

At the surface $z = 0$ this is

$$z = 0 : \bar{\sigma}_{zr} = \frac{\alpha G Q r h}{\pi c_v s a^3} \left\{ \frac{3 - [3 + 3\lambda a + (\lambda a)^2] \exp(-\lambda a)}{(\lambda a)^2} \right\}, \quad (3.391)$$

where a is given by

$$a^2 = r^2 + h^2. \quad (3.392)$$

It may be noted that the limiting value of the shear stress for $t \rightarrow \infty$ is

$$\lim_{t \rightarrow \infty} \sigma_{zr} = \lim_{s \rightarrow 0} (s \bar{\sigma}_{zr}) = \frac{\alpha G Q r h}{2\pi c_v (r^2 + h^2)^{3/2}}, \quad (3.393)$$

which is in agreement with the direct analysis of the steady state solution (Verruijt, 2008).

Additional solution

In order to balance the non-zero shear stress at the surface $z = 0$ an additional solution must be added, the solution of a problem for the half plane $z > 0$ with the boundary conditions

$$z = 0 : p = 0, \quad (3.394)$$

$$z = 0 : \bar{\sigma}_{zz} = 0, \quad (3.395)$$

$$z = 0 : \bar{\sigma}_{zr} = 2Gf(r), \quad (3.396)$$

where

$$f(r) = \frac{\alpha Q h}{2\pi s^2} \left\{ \frac{-3r + r[3 + 3\lambda a + (\lambda a)^2] \exp(-\lambda a)}{a^5} \right\}, \quad (3.397)$$

in which a is defined by $a^2 = r^2 + h^2$.

This problem can be solved using the displacement functions of McNamee-Gibson, see Chapter 8. The details of the derivation of this solution will not be given here, however. Only some of the results will be presented.

One of the most interesting quantities is the vertical displacement of the surface $z = 0$, which will be denoted by w_2 , where the subscript 2 indicates that this is the second part of the solution, which should be added to the first part, w_1 , given in equation 3.386. The Laplace transform \bar{w}_2 of the additional part is found to be

$$\bar{w}_2 = \frac{\alpha Q}{2\pi s^2} \int_0^\infty \xi \left\{ 1 - \frac{\eta \phi \lambda^2 / \phi'}{\xi^2 + \eta \lambda^2 / \phi' - \xi \sqrt{\xi^2 + \lambda^2}} \right\} \times \\ \left\{ \exp(-h\sqrt{\xi^2 + \lambda^2}) - \exp(-h\xi) \right\} J_0(r\xi) d\xi, \quad (3.398)$$

where

$$\lambda^2 = s/c_v, \quad \eta = \frac{K + \frac{4}{3}G}{2G} = \frac{1 - \nu}{1 - 2\nu}, \quad \phi = \frac{\alpha^2 + S(K + \frac{4}{3}G)}{\alpha^2 + S(K + \frac{1}{3}G)}, \quad \phi' = \phi + 2\eta(1 - \phi). \quad (3.399)$$

For very large values of time the solution reduces to the steady state solution

$$\frac{w_\infty}{w_0} = \frac{1}{\sqrt{1 + r^2/h^2}}, \quad (3.400)$$

where w_0 is the maximum displacement, just above the sink,

$$w_0 = \frac{\alpha Q(1 - \nu)}{2\pi c_v}. \quad (3.401)$$

This result is in agreement with the known solution of the steady state problem (Booker & Carter, 1986; Verruijt, 2008).

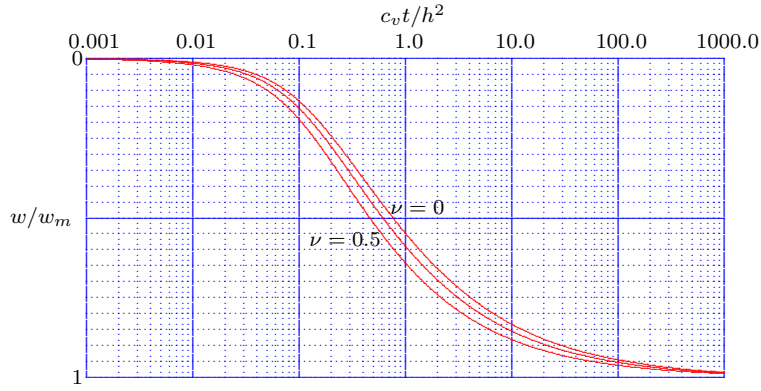

Figure 3.21: Vertical displacement of surface, for $r/h = 0$, $\nu = 0, 0.25, 0.5$.

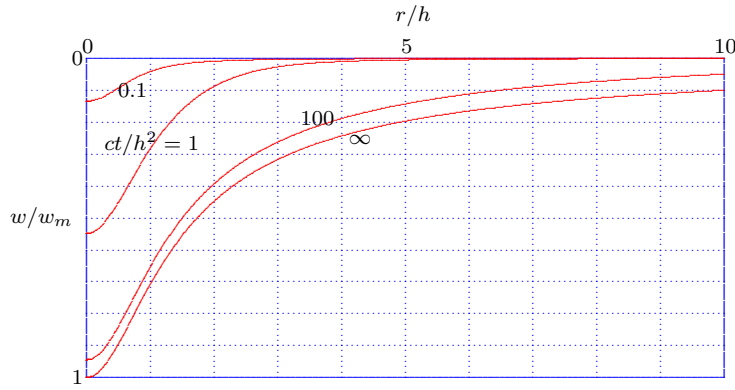

Figure 3.22: Vertical displacement of surface, for $c_v t/h^2 = 0.1, 1, 100, \infty$.

Numerical results

It seems unlikely that the inverse Hankel transform in equation (3.398) and the subsequent inversion of the Laplace transform can be evaluated in closed form. Therefore the results are calculated numerically, using Talbot's method and a numerical integration of the Hankel transform. The program SINK can be used to show numerical results.

The results of a computation of the surface displacements just above the sink (i.e. for $r/h = 0$) are shown, as a function of time, and for three values of Poisson's ratio ν , in Figure 3.21.

Figure 3.22 shows the surface displacements as a function of the radial coordinate r/h , for 3 values of time, $c_v t/h^2 = 0.1, 1.0, 100.0$, and the steady state solution (Booker & Carter, 1986). The figure confirms that the steady state solution is indeed approached for very large values of time.

The pore pressure

Another interesting quantity is the distribution of the pore pressure. This consists of two parts, with the first part being the contribution of the sink and the source, as given by equation (3.380),

$$p_1 = -\frac{Q\gamma_f}{4\pi k} \left\{ \frac{\operatorname{erfc}(\sqrt{R_1^2/4c_v t})}{R_1} - \frac{\operatorname{erfc}(\sqrt{R_2^2/4c_v t})}{R_2} \right\}. \quad (3.402)$$

The second part is the contribution of the additional solution. This is found to be

$$\bar{p}_2 = \frac{QG\eta}{\pi c_v} \int_0^\infty \bar{g} \xi^2 J_0(r\xi) d\xi, \quad (3.403)$$

where

$$\bar{g} = \frac{\xi^2 [\exp(-z\sqrt{\xi^2 + \lambda^2}) - \exp(-z\xi)] [\exp(-h\sqrt{\xi^2 + \lambda^2}) - \exp(-h\xi)]}{s[\xi^2 + b\lambda^2 - \xi\sqrt{\xi^2 + \lambda^2}]} \quad (3.404)$$

Numerical data can be obtained using the Talbot method. For $t \rightarrow \infty$ the solution reduces to the steady state limit

$$t \rightarrow \infty : p = -\frac{Q\gamma_f}{4\pi kh} \left\{ \frac{1}{\rho_1} - \frac{1}{\rho_2} \right\}. \tag{3.405}$$

A convenient reference factor for the pressures can be the final pressure at a small distance from the sink, say at the point $r = 0, z = 0.95h$. Then $\rho_1 = 0.05$ and $\rho_2 = 1.95$. This value of the pressure will be denoted by p_m .

For the numerical evaluation of data the factor $QG\eta/\pi c_v h$ of the second part p_2 should be expressed into the factor $Q\gamma_f/4\pi kh$ of the first part p_1 . This can be done using the definitions of the parameter η , in equation (3.399), and the consolidation coefficient c_v , in equation (3.359). This gives

$$\frac{QG\eta}{\pi c_v h} = 2[\alpha^2 + S(K + \frac{4}{3}G)] \frac{Q\gamma_f}{4\pi kh}. \tag{3.406}$$

If the fluid and the solids are incompressible $\alpha = 1$ and $S = 0$, the multiplication factor is 2.

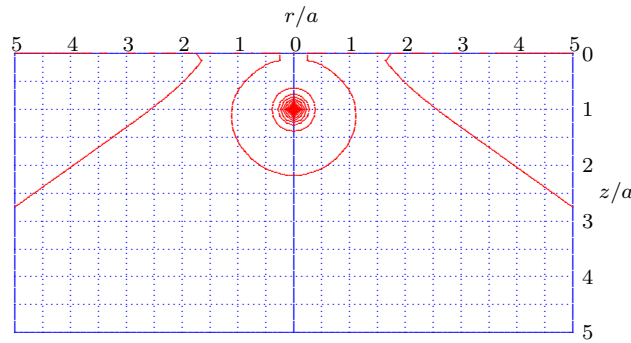

Figure 3.23: Pore pressure distribution, for $c_v t/h^2 = 0.1$.

Three examples of the contours of the pore pressure, calculated using the program SINK, are shown in Figure 3.23, Figure 3.24 and Figure 3.25, for three increasing values of $c_v t/h^2$. In Figure 3.24 the steady state has practically been reached, as can be observed by comparison with Figure 3.25.

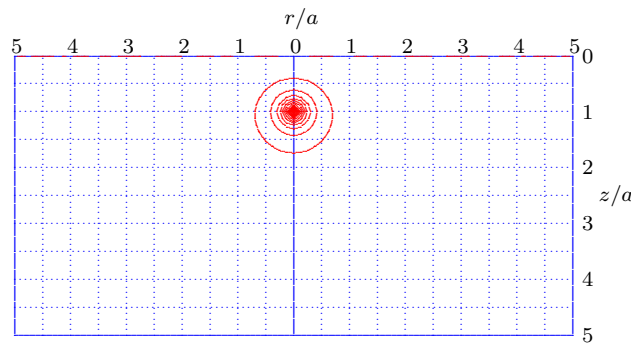

Figure 3.24: Pore pressure distribution, for $c_v t/h^2 = 10$.

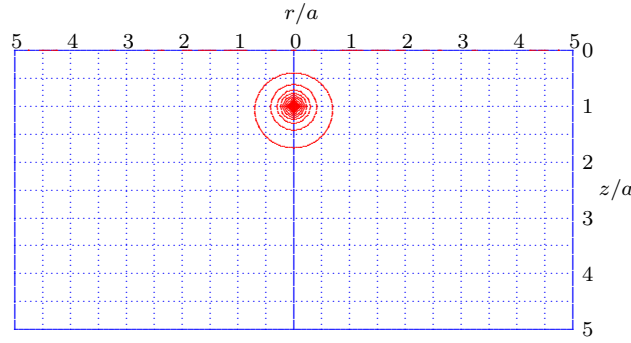

Figure 3.25: Pore pressure distribution, for $c_v t/h^2 = 1000$.

3.8 Approximate solutions

In Chapter 1 it has been shown that for problems of poroelasticity, in which a load is applied at time $t = 0$, and this load remains constant, the displacements, the stresses and the pore pressures at the moment of loading, and after the consolidation process has been completed (i.e. for $t \rightarrow \infty$) can be determined by solving two elastic problems. For the final state the pore pressures are zero, and the elastic properties are the properties under fully drained conditions: the compression modulus K and the shear modulus G . For the initial state the compression modulus K must be replaced by K_u , the undrained compression modulus, defined by

$$K_u = K + \frac{\alpha^2}{S} = K + \frac{\alpha^2}{nC_f + (\alpha - n)C_s}, \quad (3.407)$$

In this section an approximate method (Verruijt, 1980) is presented to estimate the consolidation process as a function of time, between the initial state and the final state. The method is based upon Rendulic's (1936) assumption that the isotropic total stress remains approximately constant during the consolidation process, see section 1.10.1, where this assumption is discussed in more detail.

It is assumed that the properties of the soil and the fluid are homogeneous, and that the boundary conditions are simply that a part of the boundary is fully drained, so that the pore pressure is zero, and that the remaining part of the boundary is impermeable. Even though these conditions are, mathematically speaking, very restrictive, they still cover a relatively large number of useful problems.

Approximating the consolidation process

One of the main equations governing the consolidation process is the storage equation,

$$\alpha \frac{\partial \varepsilon}{\partial t} + S \frac{\partial p}{\partial t} = \nabla \cdot \left(\frac{k}{\gamma_w} \nabla p \right), \quad (3.408)$$

which can also be written as

$$\alpha \frac{\partial \varepsilon}{\partial t} + S \frac{\partial p}{\partial t} = \frac{\partial q_x}{\partial x} + \frac{\partial q_y}{\partial y} + \frac{\partial q_z}{\partial z} = q_{i,i}, \quad (3.409)$$

where q_x , q_y , q_z are the components of the flow rate of the groundwater, and the notation $q_{i,i}$ indicates

$$q_{i,i} = \sum_{i=1}^3 \frac{\partial q_i}{\partial x_i}. \quad (3.410)$$

Assuming a linear material, the volumetric strain ε is related to the isotropic effective stress by the equation

$$\varepsilon = -C_m \sigma', \quad (3.411)$$

where C_m is the compressibility of the porous material, the inverse of its compression modulus, $C_m = 1/K$, and the minus sign is needed because of the different sign conventions used for stresses and strains. The isotropic effective stress σ' is the average of the effective stresses in the three coordinate directions,

$$\sigma' = \frac{\sigma'_{xx} + \sigma'_{yy} + \sigma'_{zz}}{3}. \quad (3.412)$$

The effective stress is the difference between total stress and pore pressure (taking into account Biot's coefficient α), and thus it follows from equation (3.411) that

$$\varepsilon = -C_m(\sigma - \alpha p). \quad (3.413)$$

Differentiating this with respect to time gives

$$\frac{\partial \varepsilon}{\partial t} = -C_m \frac{\partial \sigma}{\partial t} + \alpha C_m \frac{\partial p}{\partial t}. \quad (3.414)$$

If it is now assumed that the isotropic total stress is constant in time, then this reduces to

$$\frac{\partial \varepsilon}{\partial t} = \alpha C_m \frac{\partial p}{\partial t}. \quad (3.415)$$

Using equation (3.415) the storage equation (3.408) becomes

$$(\alpha^2 C_m + S) \frac{\partial p}{\partial t} = q_{i,i}, \quad (3.416)$$

which has the form of a diffusion equation.

If the soil properties are assumed to be constant, averaging equation (3.416) gives

$$(\alpha^2 C_m + S) V \frac{d\bar{p}}{dt} = \int_V q_{i,i} dV, \quad (3.417)$$

where the average pore pressure \bar{p} is defined as

$$\bar{p} = \frac{1}{V} \int_V p dV. \quad (3.418)$$

Using the divergence theorem equation (3.417) can be written as

$$(\alpha^2 C_m + S) V \frac{d\bar{p}}{dt} = \int_A q_i n_i dA. \quad (3.419)$$

The surface integral in the right hand side will only contain contributions from the drained part A_d of the boundary, because along the impermeable parts A_q of the boundary the normal component of the specific discharge vector q_i vanishes. If it is now furthermore assumed that the spatial variation of the pore pressure perpendicular to the boundary A_d is parabolic, between zero and a maximum value p_m , one may write

$$A_d : q_i n_i = -2 \frac{k p_m}{\gamma \ell}, \quad (3.420)$$

where ℓ is the drainage length, an estimation of the maximum path that the fluid must travel to reach the drained boundary. Because of the parabolic variation of the pore pressure the average value \bar{p} is $\frac{2}{3}$ of the maximum value p_m . It follows that

$$A_d : q_i n_i = -3 \frac{k \bar{p}}{\gamma \ell}. \quad (3.421)$$

From equations (3.419) and (3.421) the following ordinary differential equation for the average pore pressure is obtained

$$\frac{d\bar{p}}{dt} = -\frac{3c_m}{\ell \ell_d} \bar{p}, \quad (3.422)$$

where $\ell_d = V/A_d$, with A_d being the area of the drained surface, and where c_m is a consolidation coefficient defined as

$$c_m = \frac{k}{\gamma(\alpha^2 C_m + S)} = \frac{kK}{\gamma(\alpha^2 + SK)}. \quad (3.423)$$

It should be noted that this coefficient involves only the compressibility of the soil, $C_m = 1/K$. The usual consolidation coefficient is expressed in terms of the soil property $K + \frac{4}{3}G$,

$$c_v = \frac{k(K + \frac{4}{3}G)}{\gamma[\alpha^2 + S(K + \frac{4}{3}G)]}. \quad (3.424)$$

It follows that

$$\frac{c_m}{c_v} = \frac{K}{K + \frac{4}{3}G} \frac{\alpha^2 + S(K + \frac{4}{3}G)}{\alpha^2 + SK}. \quad (3.425)$$

The solution of the differential equation (3.422) is

$$\bar{p} = \bar{p}_0 \exp(-3c_m t / \ell \ell_d), \quad (3.426)$$

where \bar{p}_0 is the initial value of the average pore pressure.

Of course, equation (3.426) is only an approximation, and it can not be considered to give more than some insight into the behaviour of the pore pressure during the consolidation period.

One of the conclusions that can be drawn from equation (3.426) is that for a consolidation problem the consolidation time t_c can be estimated to be, approximately,

$$t_c \approx 7\ell \ell_d / c_m, \quad (3.427)$$

where the consolidation time t_c has been defined as the time needed for the average pore pressure to be reduced to about one-tenth of its initial value.

Example 1: Strip load on layer

The first example to be considered is the problem of a layer on a smooth bottom, with a strip load on the upper surface, see Figure 3.26. The thickness of the layer is h and the width of the strip load is $2a$. The vertical displacement of the center of the loaded area is to be determined. The analytical solution of this problem is given in detail in Chapter 7.

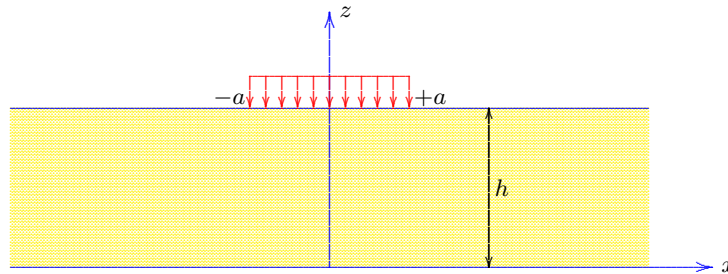

Figure 3.26: Strip load on poroelastic layer.

The final value of the vertical displacement of the point $x = 0, z = h$ should be in agreement with the result of an elastic analysis of the problem (Filon's problem), as given by Sneddon (1951). For $\nu = 0$ this value is $wG/hq = 0.506$. The initial value of the displacement can be obtained from an undrained analysis, taking $\nu = 0.5$, which gives $wG/hq = 0.253$. By analogy with the analysis in the previous section the displacement as a function of time can be approximated as

$$w = w_0 + (w_\infty - w_0)[1 - \exp(-3c_m t / \ell \ell_d)] = w_0 + (w_\infty - w_0)[1 - \exp(-6 \frac{c_m}{c_v} c_v t / h^2)], \quad (3.428)$$

where the average drainage length ℓ has been estimated to be $\ell = h/2$ and $\ell_d = V/A_d = h$. This approximate solution may be compared with the analytical solution obtained in Chapter 7.

The dots in Figure 3.27 indicate the approximation of the consolidation process, and the full line indicates the analytical solution. Both solutions apply for parameter values $\nu = 0, \alpha = 1, S = 0$ and $a/h = 1$.

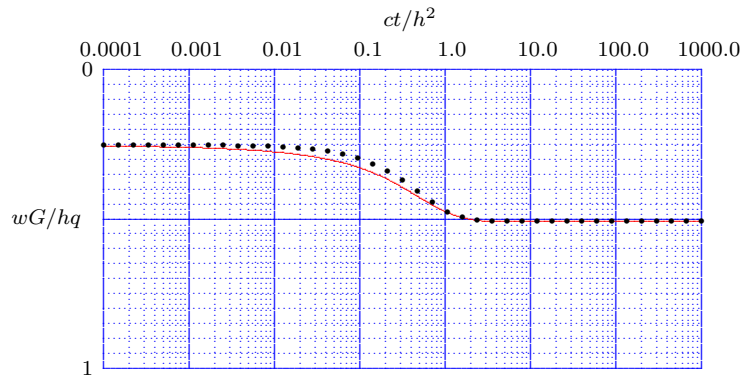

Figure 3.27: PSPL : Surface displacement.

Example 2: Cryer's problem of a sphere

The second example is the problem of a massive sphere, considered in detail in section 3.3, with drainage along the outer boundary, and loaded at this outer boundary by a constant pressure.

In this case the average drainage length can be estimated to be $\ell = a/2$, and the value of $\ell_d = V/A_d = \frac{1}{3}a$. The final volume change is $\Delta V_\infty = q/K$, where K is the compression modulus of the soil. The initial volume change, at the moment of loading is $\Delta V_0 = 0$, so that the approximation for the volume change as a function of time in this case is

$$\frac{\Delta V}{V} = -\frac{q}{K}[1 - \exp(-3c_m t/\ell\ell_d)] = -\frac{q}{K}[(1 - \exp(-18\frac{c_m}{c_v}c_v t/a^2))], \quad (3.429)$$

where, as in the first example,

$$\frac{c_m}{c_v} = \frac{K}{K + \frac{4}{3}G}. \quad (3.430)$$

The approximation, indicated by the dots, is compared with the analytical solution in Figure 3.28, for the

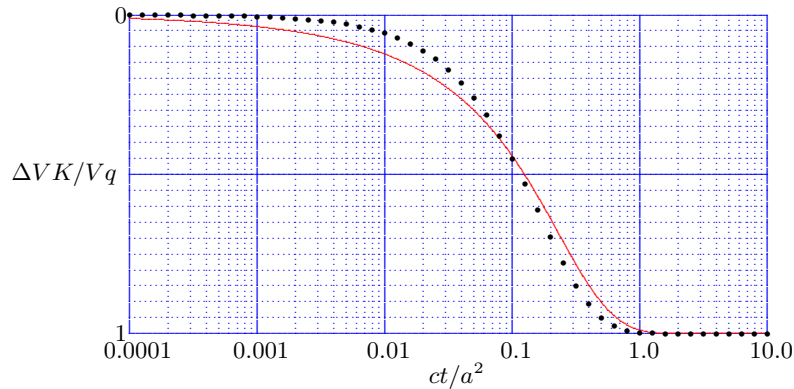

Figure 3.28: Cryer's problem : Volume change and approximation.

case $\nu = 0$. The approximation appears to be satisfactory for a first estimate.

Example 3: Terzaghi's problem

An elementary problem is the consolidation of a thin layer of soil, of thickness h , under a constant load at the upper surface. This upper surface is fully drained, and the bottom is impermeable and rigid. This is Terzaghi's problem, considered in detail in section 2.2. In this case the average drainage length can be estimated to be $\ell = h/2$, and the value of $\ell_d = V/A_d = h$. The relative volume change now can be estimated to be

$$\frac{\Delta V}{V} = -\frac{q}{K + \frac{4}{3}G}[(1 - \exp(-6\frac{c_m}{c_v}c_v t/h^2))]. \quad (3.431)$$

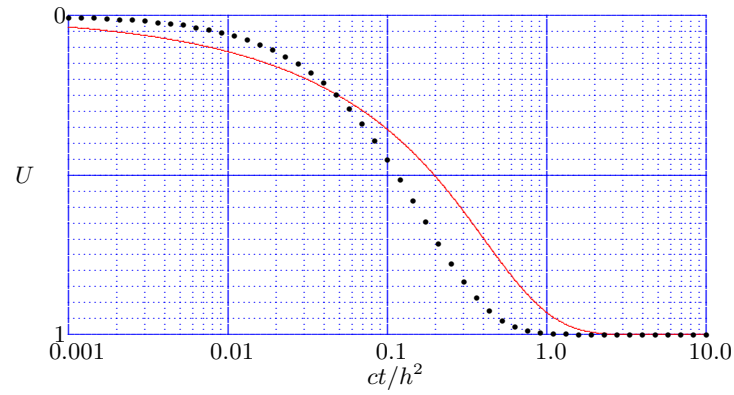

Figure 3.29: Terzaghi's problem : Degree of Consolidation.

In this case it can be expected that $c_m = c_v$ because the sample is confined laterally.

The approximation, indicated by the dots, is compared with the analytical solution in Figure 3.29. The approximation appears to be satisfactory.

SEABED RESPONSE TO WATER WAVES

4.1 Introduction

An application of the theory of poroelasticity (or consolidation) is the determination of the response of a sea bed to water waves in the sea, see figure 4.1. It is assumed that along the bottom of the sea the pressure in the water varies sinusoidally, in space as well as in time, and the problem is now to determine the pore pressures in the soil below the sea bottom, which is assumed to be a homogeneous linear elastic material.

The problem of a harmonic wave propagating along the sea bottom has been studied and solved by Yamamoto *et al.* (1978), based upon earlier work by Koning (1968). The solution has also been given by Madsen (1978) and Verruijt (1995). On the basis of this solution the forces produced on a pipeline buried near the soil surface due to the wave action were analyzed by Spierenburg (1986, 1987). In these earlier publications the compressibility of the fluid and the compressibility of the solid particles were disregarded. In this chapter the compressibility of the particles is taken into account, which requires some minor adjustments in the theory. Most of the earlier solutions applied to a wave traveling at constant speed over the seabed, but in this chapter the problem is first formulated for the case of a stationary (or standing) wave, for which the mathematics is somewhat simpler. Particular attention is paid to the limiting cases of very long and very short wave lengths.

4.2 Stationary wave

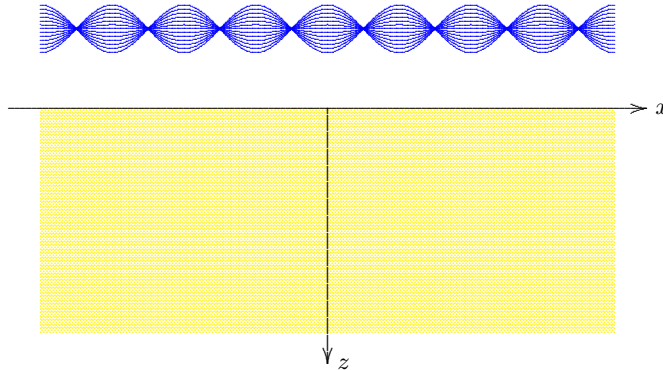

Figure 4.1: Stationary wave on a sea bed.

4.2.1 Basic equations

For the description of the deformations and stresses in a poro-elastic sea bed due to surface loading the basic equations are the equations of linear poroelasticity, see Chapter 2. These are the storage equation,

$$\alpha \frac{\partial \varepsilon}{\partial t} + S \frac{\partial p}{\partial t} = \nabla \cdot \left(\frac{k}{\gamma_w} \nabla p \right), \quad (4.1)$$

and the equations of equilibrium,

$$\left(K + \frac{1}{3}G \right) \frac{\partial \varepsilon}{\partial x} + G \nabla^2 u_x - \alpha \frac{\partial p}{\partial x} = 0, \quad (4.2)$$

$$\left(K + \frac{1}{3}G \right) \frac{\partial \varepsilon}{\partial y} + G \nabla^2 u_y - \alpha \frac{\partial p}{\partial y} = 0, \quad (4.3)$$

$$\left(K + \frac{1}{3}G \right) \frac{\partial \varepsilon}{\partial z} + G \nabla^2 u_z - \alpha \frac{\partial p}{\partial z} = 0, \quad (4.4)$$

where the body forces have been disregarded, as these may be included into the initial state of stress. If the water wave is independent of the y -direction, it may be assumed that the soil deforms under plane strain conditions, i.e. $u_y = 0$. Finally, for reasons of future simplicity, the material parameters are slightly modified. Instead of the compression modulus K a dimensionless parameter m will be used, defined by

$$m = \frac{1}{1 - 2\nu} = \frac{K + \frac{1}{3}G}{G}. \quad (4.5)$$

For an incompressible material the value of m is infinitely large, the smallest possible value of m is 1, for $\nu = 0$.

The two relevant equations of equilibrium can be written as

$$mG \frac{\partial \varepsilon}{\partial x} + G \frac{\partial^2 u_x}{\partial x^2} + G \frac{\partial^2 u_x}{\partial z^2} - \alpha \frac{\partial p}{\partial x} = 0, \quad (4.6)$$

$$mG \frac{\partial \varepsilon}{\partial z} + G \frac{\partial^2 u_z}{\partial x^2} + G \frac{\partial^2 u_z}{\partial z^2} - \alpha \frac{\partial p}{\partial z} = 0. \quad (4.7)$$

Assuming a homogeneous permeability the storage equation can now be written as

$$\alpha \frac{\partial \varepsilon}{\partial t} + S \frac{\partial p}{\partial t} = \frac{k}{\gamma_w} \left(\frac{\partial^2 p}{\partial x^2} + \frac{\partial^2 p}{\partial z^2} \right). \quad (4.8)$$

It follows from the two equations of equilibrium that

$$(m + 1)G \nabla^2 \varepsilon = \alpha \nabla^2 p, \quad (4.9)$$

and it follows from equation (4.8) that

$$\alpha G \frac{\partial \nabla^2 \varepsilon}{\partial t} + SG \frac{\partial \nabla^2 p}{\partial t} = \frac{kG}{\gamma_w} \nabla^2 \nabla^2 p. \quad (4.10)$$

Elimination of $\nabla^2 \varepsilon$ from equations (4.9) and (4.10) gives

$$\frac{\partial \nabla^2 p}{\partial t} = c_v \nabla^2 \nabla^2 p, \quad (4.11)$$

where c_v is the coefficient of consolidation,

$$c_v = \frac{kG(1 + m)}{\alpha^2(1 + \theta + m\theta)\gamma_w} = \frac{k(K + \frac{4}{3}G)}{\alpha^2(1 + \theta + m\theta)\gamma_w}, \quad (4.12)$$

and where

$$\theta = SG/\alpha^2. \quad (4.13)$$

In case of a porous medium with incompressible particles $\alpha = 1$ and $\theta = SG$. The expression (4.12) then reduces to

$$\alpha = 1 : c_v = \frac{kG(1 + m)}{[1 + SG(1 + m)]\gamma_w} = \frac{k(K + \frac{4}{3}G)}{[1 + S(K + \frac{4}{3}G)]\gamma_w}, \quad (4.14)$$

which is the usual expression for the consolidation coefficient of a material with incompressible solid particles.

The basic equations presented here are a generalization of the somewhat simpler case of a porous medium saturated with a compressible fluid of compressibility C_f , but consisting of incompressible particles (Yamamoto *et al.*, 1987). The generalization can be realized by replacing the basic variables p , S and k by αp , S/α^2 and k/α^2 , where α is the Biot coefficient. This coefficient has been defined in Chapter 1 as

$$\alpha = 1 - C_s/C_m, \quad (4.15)$$

where C_s is the compressibility of the solid particles, and C_m is the compressibility of the porous medium, $C_m = 1/K$.

4.2.2 General solution

A stationary wave can be considered by assuming that the pore pressure and the displacements are characterized by a factor $\exp(i\omega t) \cos(\lambda x)$, where ω is the frequency of the wave, and λ is its wave number.

The general solution of the problem, vanishing for $z \rightarrow \infty$, is

$$\alpha p = -\{2G\lambda A_1 \exp(-\lambda z) + G(1+m)(\xi^2 - \lambda^2)A_3 \exp(-\xi z)\} \exp(i\omega t) \cos(\lambda x), \quad (4.16)$$

$$u_x = \{[A_2 - A_1(1+m\theta)\lambda z] \exp(-\lambda z) + \lambda A_3 \exp(-\xi z)\} \exp(i\omega t) \sin(\lambda x), \quad (4.17)$$

$$u_z = \{[A_2 - A_1(1+2\theta+m\theta) - A_1(1+m\theta)\lambda z] \exp(-\lambda z) + \xi A_3 \exp(-\xi z)\} \exp(i\omega t) \cos(\lambda x), \quad (4.18)$$

where it is to be understood that in each of these equations the real part of the expressions is taken only.

The parameter ξ in the solution is defined by

$$\xi^2 = \lambda^2 + \frac{i\omega\gamma_w\alpha^2}{kG(1+m)}(1+\theta+m\theta) = \lambda^2 + \frac{i\omega}{c_v}, \quad \Re(\xi) > 0, \quad (4.19)$$

where, as before,

$$\theta = SG/\alpha^2. \quad (4.20)$$

It follows from equation (4.19) that

$$G(1+m)(\xi^2 - \lambda^2) = \frac{i\omega\gamma_w\alpha^2}{k}(1+\theta+m\theta), \quad (4.21)$$

which means that the expression for the pore pressure, equation (4.16), can also be written as

$$\alpha p = -\{2G\lambda A_1 \exp(-\lambda z) + \frac{i\omega\gamma_w\alpha^2}{k}A_3(1+\theta+m\theta) \exp(-\xi z)\} \exp(i\omega t) \cos(\lambda x). \quad (4.22)$$

The volume strain can be obtained from equations (4.17) and (4.18), with $\varepsilon = \partial u_x/\partial x + \partial u_z/\partial z$,

$$\varepsilon = \{2\lambda\theta A_1 \exp(-\lambda z) - (\xi^2 - \lambda^2)A_3 \exp(-\xi z)\} \exp(i\omega t) \cos(\lambda x), \quad (4.23)$$

or, with equation (4.21),

$$\varepsilon = \{2\lambda\theta A_1 \exp(-\lambda z) - \frac{i\omega\gamma_w\alpha^2}{kG(1+m)}(1+\theta+m\theta)A_3 \exp(-\xi z)\} \exp(i\omega t) \cos(\lambda x). \quad (4.24)$$

It can be verified without essential difficulties that this solution satisfies the differential equations (4.8), (4.6) and (4.7). It may be noted that the storage equation can be replaced in the system of three equations by the consolidation equation. This is a consequence of the fact that the consolidation equation is a combination of the storage equation and the equilibrium equations.

4.2.3 Effective stresses

The general expressions for the effective stresses are, taking into account that compressive stresses are positive, using the sign convention commonly used in soil mechanics,

$$\frac{\sigma'_{xx}}{G} = -(m-1)\varepsilon - 2\frac{\partial u_x}{\partial x}, \quad (4.25)$$

$$\frac{\sigma'_{zz}}{G} = -(m-1)\varepsilon - 2\frac{\partial u_z}{\partial z}, \quad (4.26)$$

$$\frac{\sigma'_{zx}}{G} = -\left(\frac{\partial u_z}{\partial x} + \frac{\partial u_x}{\partial z}\right). \quad (4.27)$$

It follows from equation (4.23) that

$$-(m-1)\varepsilon = \{-2(m-1)\lambda\theta A_1 \exp(-\lambda z) + (m-1)(\xi^2 - \lambda^2)A_3 \exp(-\xi z)\} \exp(i\omega t) \cos(\lambda x), \quad (4.28)$$

and it follows from equation (4.17) that

$$-2\frac{\partial u_x}{\partial x} = \{2\lambda(1+m\theta)\lambda z A_1 \exp(-\lambda z) - 2\lambda A_2 \exp(-\lambda z) - 2\lambda^2 A_3 \exp(-\xi z)\} \exp(i\omega t) \cos(\lambda x). \quad (4.29)$$

Addition of equations (4.28) and (4.29) gives

$$\frac{\sigma'_{xx}}{G} = \{[-2(m-1)\lambda\theta + 2\lambda(1+m\theta)\lambda z]A_1 \exp(-\lambda z) - 2\lambda A_2 \exp(-\lambda z) + [(m-1)(\xi^2 - \lambda^2) - 2\lambda^2]A_3 \exp(-\xi z)\} \exp(i\omega t) \cos(\lambda x), \quad (4.30)$$

It follows from equation (4.18) that

$$-2\frac{\partial u_z}{\partial z} = \{[-2\lambda(1+m\theta)\lambda z - 4\lambda\theta]A_1 \exp(-\lambda z) + 2\lambda A_2 \exp(-\lambda z) + 2\xi^2 A_3 \exp(-\xi z)\} \exp(i\omega t) \cos(\lambda x). \quad (4.31)$$

Addition of equations (4.28) and (4.31) gives

$$\frac{\sigma'_{zz}}{G} = \{[-2(m+1)\lambda\theta - 2\lambda(1+m\theta)\lambda z]A_1 \exp(-\lambda z) + 2\lambda A_2 \exp(-\lambda z) + [(m-1)(\xi^2 - \lambda^2) + 2\xi^2]A_3 \exp(-\xi z)\} \exp(i\omega t) \cos(\lambda x), \quad (4.32)$$

It follows from equation (4.17) that

$$-\frac{\partial u_x}{\partial z} = \{[\lambda(1+m\theta) - \lambda(1+m\theta)\lambda z]A_1 \exp(-\lambda z) + \lambda A_2 \exp(-\lambda z) + \lambda\xi A_3 \exp(-\xi z)\} \exp(i\omega t) \sin(\lambda x), \quad (4.33)$$

and it follows from equation (4.18) that

$$-\frac{\partial u_z}{\partial x} = \{[-\lambda(1+m\theta)\lambda z - \lambda(1+2\theta+m\theta)]A_1 \exp(-\lambda z) + \lambda A_2 \exp(-\lambda z) + \lambda\xi A_3 \exp(-\xi z)\} \exp(i\omega t) \sin(\lambda x). \quad (4.34)$$

Addition of equations (4.33) and (4.34) gives

$$\frac{\sigma'_{xz}}{G} = \{[-2\lambda(1+m\theta)\lambda z - 2\lambda\theta]A_1 \exp(-\lambda z) + 2\lambda A_2 \exp(-\lambda z) + 2\xi\lambda A_3 \exp(-\xi z)\} \exp(i\omega t) \sin(\lambda x). \quad (4.35)$$

It is recalled that in all these expressions the real part is to be taken only.

4.2.4 Boundary conditions

The region considered is the half plane $z > 0$, see figure 4.1. On the surface $z = 0$ a load is applied in the form of a stationary wave, in the total normal stress and the pore pressure. Thus the boundary conditions are supposed to be

$$z = 0 : p = \tilde{p} \exp(i\omega t) \cos(\lambda x), \quad (4.36)$$

$$z = 0 : \sigma'_{zz} = 0, \quad (4.37)$$

$$z = 0 : \sigma'_{zx} = 0. \quad (4.38)$$

The boundary condition (4.38) gives

$$\theta A_1 = A_2 + \xi A_3. \quad (4.39)$$

And the boundary condition (4.37) gives

$$2(m+1)\lambda\theta A_1 = 2\lambda A_2 + [(m+1)\xi^2 - (m-1)\lambda^2]A_3. \quad (4.40)$$

It follows from equations (4.39) and (4.40) that

$$2m\lambda\theta A_1 = [(1+m)(\xi^2 - \lambda^2) - 2\lambda(\xi - \lambda)]A_3. \quad (4.41)$$

The first boundary condition, equation (4.36) gives

$$\frac{\alpha\tilde{p}}{G} = -2\lambda A_1 - (1+m)(\xi^2 - \lambda^2)A_3. \quad (4.42)$$

With equation (4.41) this gives

$$\frac{\alpha\tilde{p}m\theta}{G} = [2\lambda(\xi - \lambda) - (1+m)(1+m\theta)(\xi^2 - \lambda^2)]A_3. \quad (4.43)$$

It follows that the constant A_3 is

$$A_3 = \frac{\alpha\tilde{p}}{G} \frac{2m\theta\lambda}{2\lambda[2\lambda(\xi - \lambda) - (1+m)(1+m\theta)(\xi^2 - \lambda^2)]}. \quad (4.44)$$

Equation (4.41) now gives

$$A_1 = \frac{\alpha\tilde{p}}{G} \frac{[(1+m)(\xi^2 - \lambda^2) - 2\lambda(\xi - \lambda)]}{2\lambda[2\lambda(\xi - \lambda) - (1+m)(1+m\theta)(\xi^2 - \lambda^2)]}. \quad (4.45)$$

And from equation (4.39) it follows that

$$A_2 = \frac{\alpha\tilde{p}}{G} \frac{2m\theta\lambda\xi + \theta[(1+m)(\xi^2 - \lambda^2) - 2\lambda(\xi - \lambda)]}{2\lambda[2\lambda(\xi - \lambda) - (1+m)(1+m\theta)(\xi^2 - \lambda^2)]}. \quad (4.46)$$

Because the parameter ξ is complex it follows that these three expressions may be complex.

For the calculation of numerical data it seems convenient to express the three constants as

$$A_1 = \frac{\alpha\tilde{p}}{G} \frac{B_1}{D}, \quad B_1 = (1+m)(\xi^2 - \lambda^2) - 2\lambda(\xi - \lambda), \quad (4.47)$$

$$A_2 = \frac{\alpha\tilde{p}}{G} \frac{B_2}{D}, \quad B_2 = 2m\theta\lambda\xi + \theta[(1+m)(\xi^2 - \lambda^2) - 2\lambda(\xi - \lambda)], \quad (4.48)$$

$$A_3 = \frac{\alpha\tilde{p}}{G} \frac{B_3}{D}, \quad B_3 = 2m\theta\lambda, \quad (4.49)$$

where D is the common denominator of the three terms,

$$D = 2\lambda[2\lambda(\xi - \lambda) - (1+m)(1+m\theta)(\xi^2 - \lambda^2)]. \quad (4.50)$$

4.2.5 The stresses

The expressions for the pore pressure and the effective stresses now are obtained as follows.

The pore pressure is obtained from equation (4.16), which gives

$$\frac{p}{\tilde{p}} = \Re \left\{ \frac{-2\lambda B_1 \exp(-\lambda z) - (1+m)(\xi^2 - \lambda^2) B_3 \exp(-\xi z)}{D} \exp(i\omega t) \cos(\lambda x) \right\}. \quad (4.51)$$

The horizontal effective stress is obtained from equation (4.30), which gives

$$\frac{\sigma'_{xx}}{\alpha\tilde{p}} = \Re \left\{ \frac{[-2(m-1)\lambda\theta + 2\lambda(1+m\theta)\lambda z] B_1 \exp(-\lambda z) - 2\lambda B_2 \exp(-\lambda z)}{D} + \frac{[(m-1)(\xi^2 - \lambda^2) - 2\lambda^2] B_3 \exp(-\xi z)}{D} \exp(i\omega t) \cos(\lambda x) \right\}. \quad (4.52)$$

The vertical effective stress is obtained from equation (4.32), which gives

$$\frac{\sigma'_{zz}}{\alpha\tilde{p}} = \Re \left\{ \frac{[-2(m+1)\lambda\theta - 2\lambda(1+m\theta)\lambda z]B_1 \exp(-\lambda z) + 2\lambda B_2 \exp(-\lambda z)}{D} + \frac{[(m-1)(\xi^2 - \lambda^2) + 2\xi^2]B_3 \exp(-\xi z)}{D} \exp(i\omega t) \cos(\lambda x) \right\}. \quad (4.53)$$

The shear stress is obtained from equation (4.35), which gives

$$\frac{\sigma'_{xz}}{\alpha\tilde{p}} = \Re \left\{ \frac{[-2\lambda(1+m\theta)\lambda z - 2\lambda\theta]B_1 \exp(-\lambda z) + 2\lambda B_2 \exp(-\lambda z)}{D} + \frac{2\xi\lambda B_3 \exp(-\xi z)}{D} \exp(i\omega t) \cos(\lambda x) \right\}. \quad (4.54)$$

Figure 4.2 shows the amplitude of the pore pressure as a function of depth, for a wave for which $T = 10$ s and $L = 100$ m, as calculated by the program SEABED. The physical parameters of the porous medium are : $\nu = 0.0$, $n = 0.4$, $C_f/C_m = 0.001$, $C_s/C_m = 0.001$, $G = 100$ kPa, $c = 0.01$ m²/s.

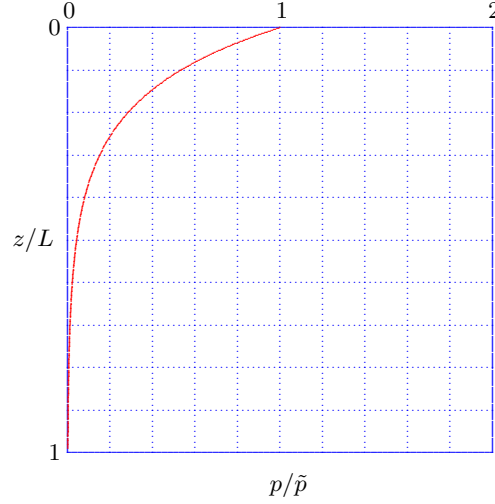

Figure 4.2: Amplitude of wave in seabed, pore pressure

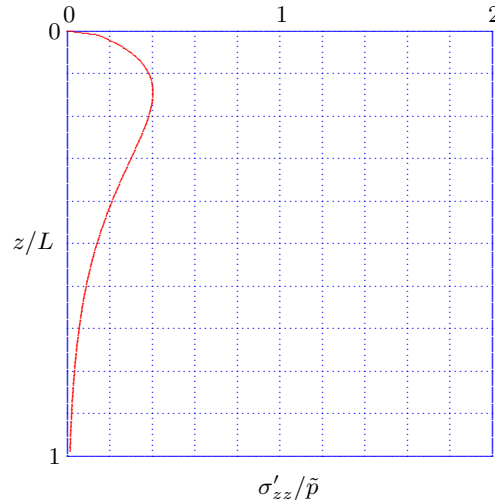

Figure 4.3: Amplitude of wave in seabed, vertical effective stress

Figure 4.3 shows the amplitude of the vertical effective stress as a function of depth, for the same wave.

4.3 Traveling wave

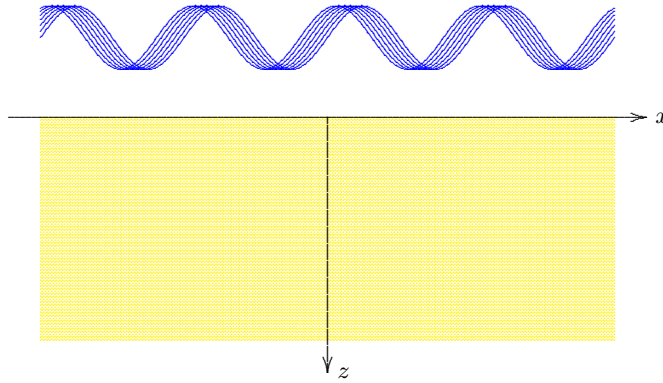

Figure 4.4: Wave traveling over a sea bed.

The solution for the case of a traveling wave, see Figure 4.4, can be established as an elementary variation of the case of a stationary wave considered in the previous section. The basic differential equations are the same, see equations (4.1) – (4.4), but the solution and the boundary conditions are slightly different. The general solution in this case is

$$\alpha p = -\{2G\lambda A_1 \exp(-\lambda z) + G(1+m)(\xi^2 - \lambda^2)A_3 \exp(-\xi z)\} \exp[i(\omega t - \lambda x)], \quad (4.55)$$

$$u_x = \{[A_2 - A_1(1+m\theta)\lambda z] \exp(-\lambda z) + \lambda A_3 \exp(-\xi z)\} i \exp[i(\omega t - \lambda x)], \quad (4.56)$$

$$u_z = \{[A_2 - A_1(1+2\theta+m\theta) - A_1(1+m\theta)\lambda z] \exp(-\lambda z) + \xi A_3 \exp(-\xi z)\} \exp[i(\omega t - \lambda x)], \quad (4.57)$$

where, as before, ξ is defined by

$$\xi^2 = \lambda^2 + \frac{i\omega\gamma_w\alpha^2}{kG(1+m)}(1+\theta+m\theta) = \lambda^2 + \frac{i\omega}{c_v}, \quad \Re(\xi) > 0, \quad (4.58)$$

and where, as before,

$$\theta = SG/\alpha^2. \quad (4.59)$$

In all three equations (4.55), (4.56) and (4.57) only the real part of the expressions should be taken.

The boundary conditions in this case are

$$z = 0 : p = \bar{p} \exp[i(\omega t - \lambda x)], \quad (4.60)$$

$$z = 0 : \sigma'_{zz} = 0, \quad (4.61)$$

$$z = 0 : \sigma'_{zx} = 0. \quad (4.62)$$

Using these boundary conditions it appears that the values of the three constants A_1 , A_2 and A_3 in the solution appear to be exactly the same as in the previous solution. It also follows that the amplitudes of the pore pressure and the effective stresses are the same as before, see Figures 4.2 and 4.3.

4.4 Approximation of waves

4.4.1 Incompressibility of fluid and solid particles

The general solution greatly simplifies, as mentioned already by Yamamoto *et al.* (1978), Madsen (1978) and others, when the fluid and the solid particles are incompressible. The parameter θ then reduces to 0, see equation (4.13) and (4.15). It then follows from equations (4.44) and (4.46) that $A_2 = A_3 = 0$, and it follows from equation (4.47) and (4.50) that $B_1/D = -1/2\lambda$. Equation (4.51) then gives

$$\frac{p}{\tilde{p}} = \Re\{\exp(-\lambda z) \exp(i\omega t) \cos(\lambda x)\}, \quad (4.63)$$

which means that the amplitude of the pore pressure is simply $\tilde{p} \exp(-\lambda z)$. It can also be shown that in this case the volume strain is zero, and that the pore pressure satisfies the Laplace equation, which has been found before by many researchers, see Yamamoto *et al.* (1978) and Madsen (1978).

Actually, the program SEABED can be used to investigate the influence of the wave parameters and the soil parameters on the distribution of the pore pressure and the effective stresses as a function of depth. It then appears that the distribution of the pore pressure hardly ever deviates from the approximate result (4.63), whatever the parameters are. However, the horizontal and vertical effective stresses depend significantly upon some of the parameters, as can be determined by running the program for various values of the parameters.

4.4.2 Long waves

The most important parameter influencing the behaviour of the waves is the parameter ξ , which is defined by equation (4.19) or (4.58),

$$\xi^2 = \lambda^2 + \frac{i\omega}{c_v}, \quad \Re(\xi) > 0. \quad (4.64)$$

It follows that

$$\xi = \lambda \sqrt{1 + i\psi}, \quad \Re(\xi) > 0, \quad (4.65)$$

where ψ is a dimensionless wave parameter, defined as

$$\psi = \frac{\omega}{c_v \lambda^2} = \frac{L^2}{2\pi c_v T}. \quad (4.66)$$

The value of this factor depends upon the wave parameters L and T and the consolidation coefficient of the soil c_v . It may be assumed that a significant frequency of sea waves is about such that $T \approx 10$ s, and significant values for the wave length are about $L \approx 10 - 100$ m. On the other hand, for normal sands the consolidation coefficient is about $c_v \approx 0.01$ m^2/s , and for finer soils such as silt or clay the consolidation coefficient is even much smaller. This means that it can be expected that $\psi > 100$, except for very coarse soils such as gravel.

For a large value of ψ the absolute value of the parameter ξ will be very large compared to λ . The expression for the pore pressure, equation (4.51), then reduces to

$$\psi \gg 1 : \frac{p}{\tilde{p}} = \Re\left\{ \frac{\exp(-\lambda z) + m\theta \exp(-\xi z)}{1 + m\theta} \exp(i\omega t) \cos(\lambda x) \right\}. \quad (4.67)$$

The effect of the second term is rapidly attenuated with depth, so that the solution will be close to the approximation (4.63). This can easily be verified using the computer program SEABED.

Chapter 5

FLOW TO WELLS

5.1 Introduction

This chapter presents the solution of some problems of flow to a well, with special attention to the vertical and horizontal displacements. In early publications (Theis, 1935; Jacob, 1940) the horizontal displacements were assumed to vanish, which leads to a considerable simplification in the basic equations. Later, the theory was generalized, and based upon the three dimensional theory of consolidation (Biot, 1941). This has resulted in models in which the horizontal displacements are also taken into account (Verruijt, 1969, 1970; Gambolati, 1974; Bear & Corapcioglu, 1981; Helm, 1994; Hsieh & Cooley, 1995). These studies indicate that the horizontal displacements in a pumped aquifer may be of the same order of magnitude as the vertical displacements, and therefore should not be disregarded. This has been confirmed by measurements in the field (Wolff, 1970).

Another generalization presented in this chapter is the analysis of wells in aquifers of finite radial extent. This enables to investigate the behaviour of the pore pressure and the displacements up to a final steady state, using numerical methods (Schapery's inversion method or Talbot's inversion method) for the inverse Laplace transformation of the solutions.

5.2 A well in an infinite confined aquifer

The first problem to be considered is the non-steady flow to a well in a confined aquifer of infinite extent, a classical problem of geohydrology first solved by Theis (1935), and given in many textbooks (Muskat, 1937; Polubarinova-Kochina, 1962; De Wiest, 1965; Bear, 1979; Verruijt, 1982; Strack, 1989).

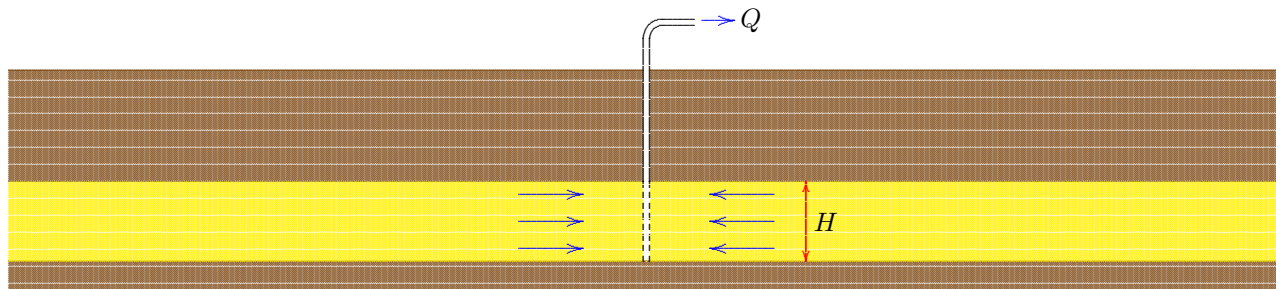

Figure 5.1: Well in infinite confined aquifer, Theis-Jacob model.

The basic equation for this problem can be derived starting from the equation of continuity of the pore fluid, or the storage equation, see Chapter 1, equation (1.27),

$$\alpha \frac{\partial \varepsilon}{\partial t} + S \frac{\partial p}{\partial t} + \nabla \cdot \mathbf{q} = 0, \quad (5.1)$$

where ε is the volumetric strain of the porous medium, p is the pore pressure, and \mathbf{q} is the specific discharge of the fluid with respect to the porous medium. The coefficient S is the storativity, which can be expressed as

$$S = nC_f + (\alpha - n)C_s, \quad (5.2)$$

where n is the porosity of the porous medium, C_f is the compressibility of the pore fluid, C_s is the compressibility of the particle material, and α is Biot's coefficient,

$$\alpha = 1 - C_s/C_m, \quad (5.3)$$

where C_m is the compressibility of the porous medium in the case of full drainage. This coefficient can also be expressed as

$$C_m = 1/K, \quad (5.4)$$

where K is the (linear elastic) compression modulus of the porous medium.

Using Darcy's law equation (5.1) can be written as

$$\alpha \frac{\partial \varepsilon}{\partial t} + S \frac{\partial p}{\partial t} = \frac{k}{\gamma_f} \nabla^2 p, \quad (5.5)$$

where k is the hydraulic conductivity of the porous medium and γ_f is the volumetric weight of the fluid. The factor k/γ_f can also be written as κ/μ , where κ is the permeability of the porous medium and μ is the viscosity of the pore fluid.

In the classical approach, due to Theis (1935) and Jacob (1940), it is assumed that there are no horizontal deformations in the aquifer, so that the volume strain equals the vertical strain,

$$\varepsilon = \varepsilon_{zz}. \quad (5.6)$$

Assuming linear elastic deformations the vertical strain can be related to the incremental vertical effective stress σ'_{zz} by the relation

$$\varepsilon_{zz} = -\frac{\sigma'_{zz}}{K + \frac{4}{3}G}, \quad (5.7)$$

where the minus-sign is due to the different sign conventions for strains (positive for extension) and stresses (positive for compression). The quantity $K + \frac{4}{3}G$ is the elastic modulus for horizontally confined deformations.

The effective stress can be expressed by Terzaghi's relation, as modified by Biot (1941) for compressible particles,

$$\sigma'_{zz} = \sigma_{zz} - \alpha p. \quad (5.8)$$

The second basic assumption of the classical approach is that the vertical total stress σ_{zz} remains constant during the development of the hydrological process, so that

$$\frac{\partial \sigma_{zz}}{\partial t} = 0. \quad (5.9)$$

It now follows from the above equations that

$$\alpha \frac{\partial \varepsilon}{\partial t} = -\frac{\alpha}{K + \frac{4}{3}G} \frac{\partial \sigma'_{zz}}{\partial t} = \frac{\alpha^2}{K + \frac{4}{3}G} \frac{\partial p}{\partial t}. \quad (5.10)$$

Substitution of this result in equation (5.1) gives

$$\frac{\partial p}{\partial t} = c_v \nabla^2 p, \quad (5.11)$$

where c_v is the coefficient of consolidation,

$$c_v = \frac{k(K + \frac{4}{3}G)}{\gamma_f[\alpha^2 + S(K + \frac{4}{3}G)]}. \quad (5.12)$$

It may be noted that in the classical analysis of Terzaghi, Theis and Jacob the fluid and the particles are assumed to be incompressible, so that $\alpha = 1$ and $S = 0$. The consolidation coefficient then reduces to

$$\alpha = 1, S = 0: c_v = \frac{k(K + \frac{4}{3}G)}{\gamma_f}. \quad (5.13)$$

In the case of radial flow equation (5.11) becomes

$$\frac{\partial p}{\partial t} = c_v \left(\frac{\partial^2 p}{\partial r^2} + \frac{1}{r} \frac{\partial p}{\partial r} \right). \quad (5.14)$$

The solution of the differential equation (5.14) can most conveniently be derived by introducing the Laplace transform of the pressure,

$$\bar{p} = \int_0^\infty p \exp(-st) dt. \quad (5.15)$$

The differential equation transforms into

$$\frac{d^2\bar{p}}{dr^2} + \frac{1}{r} \frac{d\bar{p}}{dr} - \frac{s}{c_v} \bar{p} = 0, \quad (5.16)$$

where it has been assumed that the initial pore pressure, at the time that the well starts operating, is zero.

The solution of the differential equation (5.16) is

$$\bar{p} = AI_0(r\sqrt{s/c_v}) + BK_0(r\sqrt{s/c_v}). \quad (5.17)$$

The Bessel function $I_0(x)$ increases indefinitely at infinity, whereas the Bessel function $K_0(x)$ tends towards zero. This suggests that $A = 0$, to avoid infinitely large pore pressures at infinity. The boundary condition at the inner boundary is

$$r \rightarrow 0 : 2\pi r H \frac{k}{\gamma_f} \frac{\partial p}{\partial r} = QH(t), \quad (5.18)$$

where Q is the discharge of the well and $H(t)$ is Heaviside's unit step function,

$$H(t) = \begin{cases} 0 & \text{if } t < 0, \\ 1 & \text{if } t > 0. \end{cases} \quad (5.19)$$

The Laplace transform of the boundary condition (5.18) is

$$r \rightarrow 0 : 2\pi r H \frac{k}{\gamma_f} \frac{d\bar{p}}{dr} = \frac{Q}{s}. \quad (5.20)$$

From this condition the coefficient B can be determined. The transformed solution then is found to be

$$\bar{p} = -\frac{Q\gamma_f}{2\pi k H s} K_0(r\sqrt{s/c_v}). \quad (5.21)$$

Inverse transformation finally gives

$$p = -\frac{Q\gamma_f}{4\pi k H} E_1(r^2/4c_v t), \quad (5.22)$$

where $E_1(x)$ is the exponential integral (Abramowitz & Stegun, 1964), see Figure 5.2.

$$E_1(x) = \int_x^\infty \frac{\exp(-t)}{t} dt. \quad (5.23)$$

It may be noted and verified that

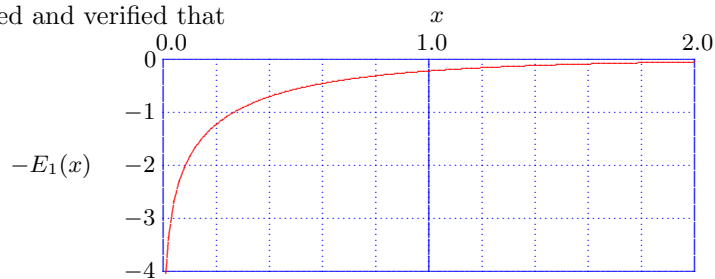

Figure 5.2: Exponential Integral.

$$\frac{dE_1(x)}{dx} = -\frac{\exp(-x)}{x}. \quad (5.24)$$

The solution (5.22) has the inconvenient properties that for $t \rightarrow \infty$, and for $r \rightarrow 0$, the pore pressure tends to $-\infty$, which implies that there is no steady state limit to the solution. This is a well known property of this simplest problem of flow to a well in an aquifer of infinite radial extent and without supply of water from above or below (Polubarinova-Kochina, 1962; Verruijt, 1970). The impossibility of the steady production of water from a well in a confined aquifer of infinite extent means, for instance, that there is no hope to permanently solve the lack of water in the dry center of Australia by pumping water from a deep aquifer.

5.2.1 Vertical displacement

The incremental vertical strain now is, from equation (5.10), with $\varepsilon = \varepsilon_{zz}$,

$$\varepsilon_{zz} = \frac{\alpha p}{K + \frac{4}{3}G}. \quad (5.25)$$

Assuming that at the lower surface of the aquifer the vertical displacement is zero, and denoting the vertical displacement of the upper surface by w , it follows that

$$\frac{w}{H} = -\frac{\alpha Q \gamma_f}{4\pi k H (K + \frac{4}{3}G)} E_1(r^2/4c_v t). \quad (5.26)$$

Again there appears to be no steady state solution for $t \rightarrow \infty$.

5.3 Superposition and images

Because the basic differential equations are linear the solution for multiple wells can be obtained by superposition of the individual wells. In case that the discharges of the wells are such that the sum of the discharges is zero, there may be a steady state solution, which is convenient for practical and theoretical purposes.

The simplest example is the case of a pumping well and a recharge well, see Figure 5.3. If the vertical

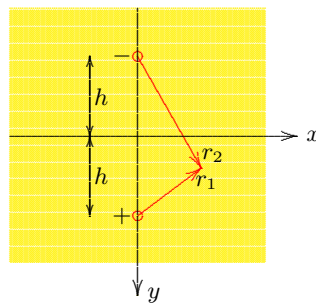

Figure 5.3: A well and a recharge well.

distance from each of the wells to the x -axis is h , the distance from an arbitrary point x, y to the two wells is

$$r_1 = \sqrt{x^2 + (y - h)^2}, \quad r_2 = \sqrt{x^2 + (y + h)^2}. \quad (5.27)$$

The solution for the flow problem involving a discharge well at $x = 0, y = h$ and a recharge well at $x = 0, y = -h$ is, by superposition of two solutions of the general type of equation (5.22),

$$p = -\frac{Q \gamma_f}{4\pi k H} \{E_1(r_1^2/4c_v t) - E_1(r_2^2/4c_v t)\}. \quad (5.28)$$

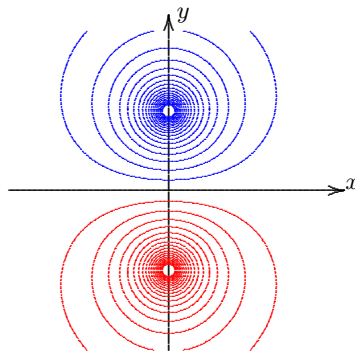

Figure 5.4: Two wells : pore pressure.

Contours of the pore pressure in the horizontal plane are shown in Figure 5.4. The color difference indicates the sign difference in the pore pressure increment. The symmetry in the figure is a consequence of the symmetry in the problem. It appears, for instance, that the pore pressure increment is zero along the axis of symmetry, $y = 0$. Actually, the lower half of the problem can be interpreted as the solution of a problem for a single well in an aquifer bounded by a canal in which the water level remains constant, see Figure 5.5. The generation

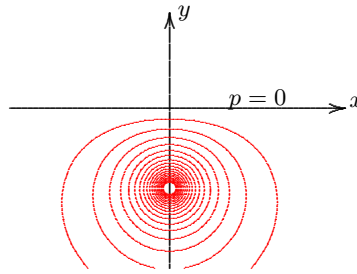

Figure 5.5: Well near canal : pore pressure.

of the solution of a problem by considering only one half (or one quarter) of the problem and its symmetric counterpart is often denoted as the method of images, see classical books on potential theory (Kellogg, 1929; Morse & Feshbach, 1953). and books on groundwater flow (Verruijt, 1970; Bear, 1979; Strack, 1989). In many of these problems a steady state solution exists, provided that there is at least one boundary along which the pressure remains constant, so that there is a possibility of a supply of water.

5.4 A well in a finite confined aquifer

It has been seen in section 5.2 that problems for the two-dimensional case of flow in a completely confined aquifer may have a practical solution only if the total supply of water to the aquifer is zero. This is particularly inconvenient for an aquifer of infinite extent, for which the solution, by Theis (1935) and Jacob (1940), degenerates if time tends towards infinity. It will be shown in this section that these difficulties can be overcome if the aquifer does not extend towards infinity, but is bounded by a boundary with a prescribed water level. The problem to be considered here is the non-steady flow to a well in the center of a circular confined aquifer, bounded by a radius R , see Figure 5.6. A first approximation of the solution for this problem was given by Sternberg (1969), using Schapery's (1962) method for the inverse Laplace transform.

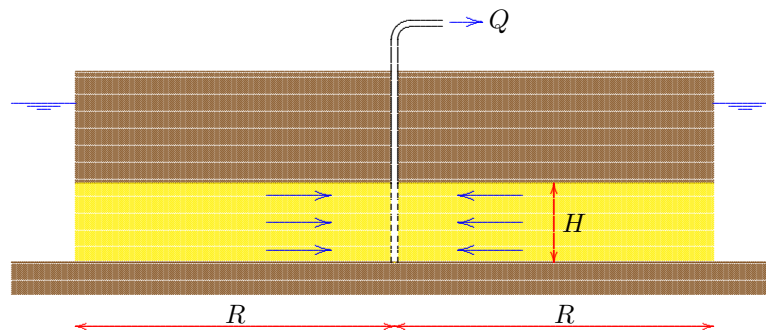

Figure 5.6: A well in a finite confined aquifer, Theis-Jacob model.

The basic equations for this problem are the same as in the previous section, and the general solution in terms of the Laplace transform of the pore pressure is, see equation (5.17),

$$\bar{p} = AI_0(r\sqrt{s/c_v}) + BK_0(r\sqrt{s/c_v}), \quad (5.29)$$

where $I_0(x)$ and $K_0(x)$ are modified Bessel functions of order zero and of the first and second kind (Abramowitz & Stegun, 1964).

The boundary condition at the inner boundary is supposed to be

$$r \rightarrow 0 : 2\pi r H \frac{k}{\gamma_f} \frac{\partial p}{\partial r} = QH(t), \quad (5.30)$$

where Q is the discharge of the well, and $H(t)$ is Heaviside's unit step function,

$$H(t) = \begin{cases} 0 & \text{if } t < 0, \\ 1 & \text{if } t > 0. \end{cases} \quad (5.31)$$

And the boundary condition at the outer boundary is supposed to be

$$r = R : p = 0, \quad (5.32)$$

which expresses that the pressures are considered with respect to the water level at the outer boundary.

The constants A and B can be determined from the Laplace transforms of the boundary conditions (5.30) and (5.32). The final result for the Laplace transform of the pore pressure is

$$\bar{p} = -\frac{Q\gamma_f}{2\pi kHs} \left\{ K_0(r\sqrt{s/c_v}) - \frac{K_0(R\sqrt{s/c_v})}{I_0(R\sqrt{s/c_v})} I_0(r\sqrt{s/c_v}) \right\}. \quad (5.33)$$

5.4.1 Steady flow

Before attempting to determine the inverse Laplace transform of equation (5.33) it may be useful to determine the steady state solution, which can be obtained from this equation using the theorem (Carslaw & Jaeger, 1948) that

$$\lim_{t \rightarrow \infty} p = \lim_{s \rightarrow 0} s \bar{p}. \quad (5.34)$$

Using the approximations

$$x \rightarrow 0 : I_0(x) = 1, \quad K_0(x) = \ln(1.123/x), \quad (5.35)$$

it follows that

$$\lim_{t \rightarrow \infty} p = \frac{Q\gamma_f}{2\pi kH} \ln(r/R), \quad (5.36)$$

which is a well known result from elementary geohydrology (Muskat, 1937; Polubariva-Kochina, 1962; De Wiest, 1965; Verruijt, 1970; Bear, 1979; Strack, 1989).

5.4.2 General solution

Unfortunately, it seems unlikely that the inverse Laplace transform of equation (5.33) for the general case of non-steady flow can be determined in closed form. However, effective numerical methods of inversion have been developed.

For such a numerical inversion of the Laplace transform it is convenient to introduce dimensionless variables as

$$\tau = c_v t / R^2, \quad \sigma = R^2 s / c_v, \quad \rho = r / R, \quad v = p / q, \quad (5.37)$$

where q is a reference pressure, defined by

$$q = \frac{Q\gamma_f}{2\pi kH}. \quad (5.38)$$

The Laplace transform solution (5.33) can now be written as

$$\frac{\bar{p}}{q} = -\frac{R^2}{c_v \sigma} \left\{ K_0(\rho\sqrt{\sigma}) - \frac{K_0(\sqrt{\sigma})}{I_0(\sqrt{\sigma})} I_0(\rho\sqrt{\sigma}) \right\}. \quad (5.39)$$

And the definition of the Laplace transform, equation (5.15), now gives, dividing both sides by q ,

$$\frac{\bar{p}}{q} = \frac{R^2}{c_v} \int_0^\infty \frac{p}{q} \exp(-\sigma\tau) d\tau = \frac{R^2}{c_v} \int_0^\infty v \exp(-\sigma\tau) d\tau = \frac{R^2}{c_v} \bar{v}. \quad (5.40)$$

It follows from equations (5.39) and (5.40) that

$$\bar{v} = \frac{\bar{p}}{q} = -\frac{1}{\sigma} \left\{ K_0(\rho\sqrt{\sigma}) - \frac{K_0(\sqrt{\sigma})}{I_0(\sqrt{\sigma})} I_0(\rho\sqrt{\sigma}) \right\}. \quad (5.41)$$

Equation (5.41) is suitable for the application of numerical inversion methods.

The simplest numerical method is Schapery's method (Schapery, 1962),

$$F(t) = \{s\overline{f(s)}\}_{s=1/2t}. \quad (5.42)$$

Figure 5.7 shows the results of numerical calculations of the pressure as a function of r/R using this method,

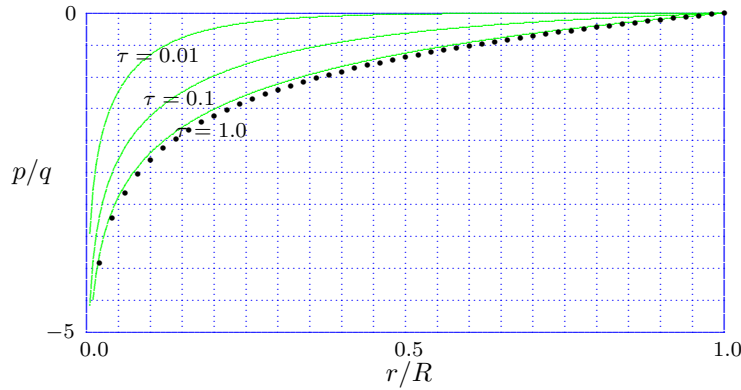

Figure 5.7: Finite aquifer : Schapery inversion, Theis-Jacob model.

for three values of the dimensionless time parameter $\tau = c_v t/R^2$.

A more accurate method was developed by Talbot (1979), see also Abate & Whitt (2006). Talbot's algorithm for the computation of an approximation $F(t, M)$ of a Laplace transform $f(s)$ is

$$F(t, M) \approx \frac{2}{5t} \sum_{k=0}^{M-1} \Re\{\gamma_k f(\delta_k/t)\}, \quad (5.43)$$

where M is an integer indicating the number of terms in the approximation (e.g. $M = 10$ or $M = 20$), and where

$$\delta_0 = \frac{2M}{5}, \quad \delta_k = \frac{2k\pi}{5} [\cot(k\pi/M) + i], \quad 0 < k < M, \quad (5.44)$$

$$\gamma_0 = \frac{\exp(\delta_0)}{2}, \quad \gamma_k = \left\{ 1 + i(k\pi/M)(1 + [\cot(k\pi/M)]^2) - i \cot(k\pi/M) \right\} \exp(\delta_k), \quad 0 < k < M. \quad (5.45)$$

It may be noted that for $k > 0$ the coefficients δ_k and γ_k are complex. This means that the values of the Laplace transform parameter appearing in equation (5.43) are also complex.

Because this numerical inversion method uses a number of values of the Laplace transform in points where the Laplace transform parameter s , or its dimensionless form σ , is complex, it is necessary in this case to determine the values of the Bessel functions I_0 and K_0 for complex arguments. These can be calculated using the algorithms given in section 5.7. Figure 5.8 shows the results of numerical calculations of the pore pressure as a function of r/R using the Talbot method, for three values of the dimensionless time parameter $\tau = c_v t/R^2$. The curve for $\tau = 1.0$ practically coincides with the steady state solution, as expressed by equation (5.36), and shown in the figure by black dots. This is confirmed by plotting the pore pressures as a function of τ , for three values of r/R , see Figure 5.9. In this figure it can be seen that the value of p/q for $\tau = 1.0$ is practically equal to the value for $\tau = 10.0$.

5.4.3 Comparison with finite difference solution

The problem considered in this chapter of a well in a circular region of finite radius can also be solved numerically, for instance using the finite difference method. The dimensionless form of the differential equation

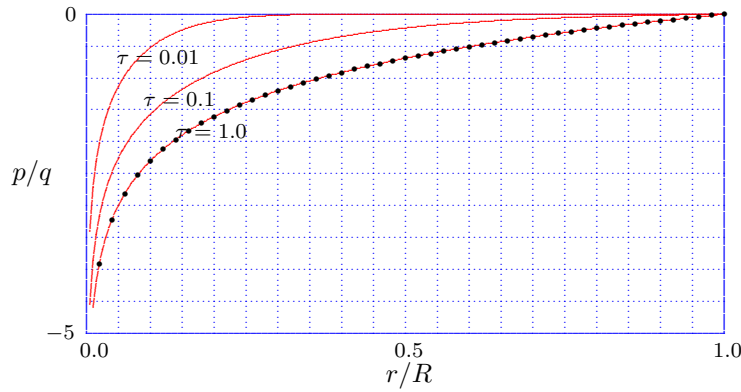
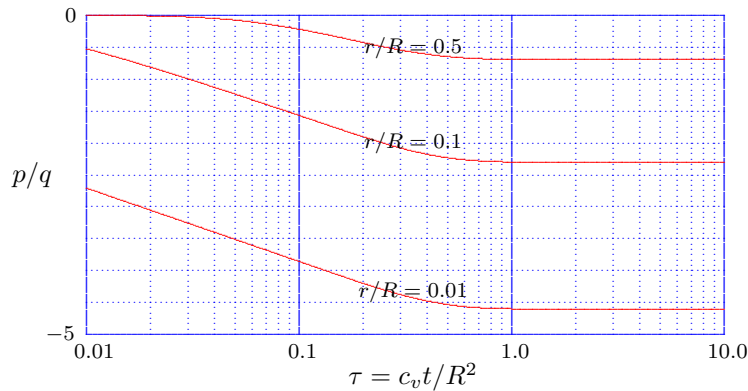

Figure 5.8: Finite aquifer : Talbot inversion, Theis-Jacob model.

Figure 5.9: Finite Aquifer : Pore pressure as a function of τ , Theis-Jacob model.

(5.14) is

$$\frac{\partial v}{\partial \tau} = \frac{\partial^2 v}{\partial \rho^2} + \frac{1}{\rho} \frac{\partial v}{\partial \rho}, \quad (5.46)$$

and the boundary conditions (5.30) and (5.32) can be expressed in dimensionless form as

$$\rho \rightarrow 0 : \rho \frac{\partial v}{\partial \rho} = q, \quad (5.47)$$

$$\rho = 1 : v = 0. \quad (5.48)$$

The main algorithm for a finite difference solution is

$$v'_i = v_i + \frac{\Delta \tau}{(\Delta \rho)^2} \{v_{i+1} - 2v_i + v_{i-1} + \frac{\Delta \rho}{2\rho} (v_{i+1} - v_{i-1})\}, \quad i = 1, 2, \dots, n, \quad (5.49)$$

where n is the number of intervals in radial direction, so that $\Delta \rho = 1/n$. The finite difference form of the boundary conditions is

$$v_0 = v_1 - 2q, \quad (5.50)$$

$$v_n = 0. \quad (5.51)$$

The results of the finite difference solution for three values of τ are compared with the results obtained earlier by the inversion of the Laplace transform solution using the Talbot method in Figure 5.10. The finite difference results are indicated by the black dots. The agreement between the two solution methods appears to be good.

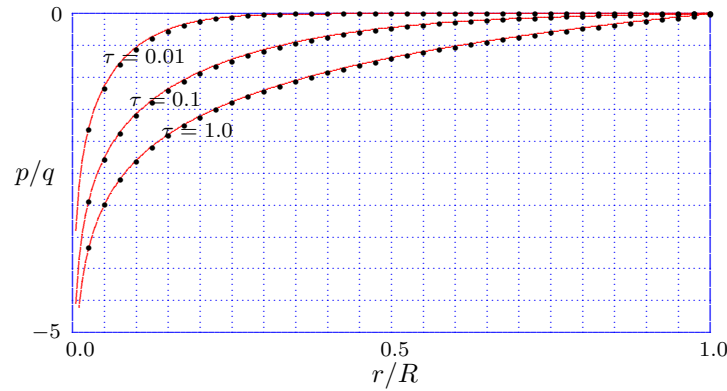

Figure 5.10: Comparison of inverse Laplace transformation and finite difference solution.

5.5 A plane stress model

The approximation to problems of consolidation of flow in aquifers by assuming that the horizontal displacements can be disregarded with respect to the vertical displacements, as assumed in the previous section 5.2, may be justified as a first approximation for problems of soil mechanics in which the load consists of a vertical load only, and the settlement due to such loads is to be determined. In problems of groundwater flow to wells the approximation does not seem to be justified, because it is not consistent with the horizontal flow of groundwater, which exerts a horizontal force on the soil skeleton. Indeed, horizontal deformations, of the same order of magnitude as the vertical ones, have been measured (Wolff, 1970).

An improved schematization has been suggested (Verruijt, 1969) on the basis of Biot's theory of three dimensional consolidation (Biot, 1941), and the additional assumptions that the total stresses on horizontal planes in the aquifer remain constant during the consolidation process. This model was used to determine the pore pressure distribution in a semi-confined aquifer, and the model has been completed to include the horizontal and vertical displacements by Bear & Corapcioglu (1981). An extreme version of this approach, disregarding all vertical deformations, has been suggested by Helm (1994), but this has been shown to be too restrictive (Hsieh & Cooley, 1995).

In the model presented in this section it is assumed that the aquifer deforms in a state of plane total stress. This means that the vertical total stress remains unchanged during the deformation due to the flow to the well, and that the shear stress also remains unchanged (i.e. zero). Compared with the classical theory of Theis and Jacob the assumption that the vertical total stress remains unchanged is maintained, but the assumption of zero horizontal displacements is replaced by the assumption that the radial shear stresses vanish.

5.5.1 A well in an infinite aquifer, plane stress model

In this section the solution for a well in a confined aquifer of infinite extent will be given, using the plane stress model.

5.5.2 Basic equations

Because in this model the incremental vertical total stress is zero, it follows that $\sigma'_{zz} + \alpha p = 0$ so that, with Hooke's law,

$$-(K - \frac{2}{3}G)\varepsilon - 2G\frac{\partial u_z}{\partial z} + \alpha p = 0. \quad (5.52)$$

For axially symmetric deformations the volume strain can be expressed as

$$\varepsilon = \frac{\partial u_r}{\partial r} + \frac{u_r}{r} + \frac{\partial u_z}{\partial z}. \quad (5.53)$$

It follows from equations (5.52) and (5.53) that

$$-(K + \frac{4}{3}G)\varepsilon + 2G\left(\frac{\partial u_r}{\partial r} + \frac{u_r}{r}\right) + \alpha p = 0. \quad (5.54)$$

Because the incremental shear stress is assumed to be zero in this model, $\sigma_{zr} = \sigma'_{zr} = 0$, the equilibrium equation in radial direction reduces to

$$\frac{\partial \sigma'_{rr}}{\partial r} + \frac{\sigma'_{rr} - \sigma'_{tt}}{r} + \alpha \frac{\partial p}{\partial r} = 0. \quad (5.55)$$

With Hooke's law this gives

$$-(K - \frac{2}{3}G) \frac{\partial \varepsilon}{\partial r} - 2G \frac{\partial}{\partial r} \left(\frac{\partial u_r}{\partial r} + \frac{u_r}{r} \right) + \alpha \frac{\partial p}{\partial r} = 0. \quad (5.56)$$

Integration with respect to r gives

$$-(K - \frac{2}{3}G)\varepsilon - 2G \left(\frac{\partial u_r}{\partial r} + \frac{u_r}{r} \right) + \alpha p = 2Gf, \quad (5.57)$$

where f is a dimensionless integration constant, actually a function of z and t . For the case of an infinite aquifer this integration constant can be assumed to be zero, on the basis of the assumption that at infinity the pore pressure and all strains vanish, for all values of z and t .

Addition of equations (5.54) and (5.57) now gives, with $f = 0$.

$$(K + \frac{1}{3}G)\varepsilon = \alpha p. \quad (5.58)$$

It now follows from equation (5.58) and either of equations (5.56) or (5.57) that

$$\frac{\partial u_r}{\partial r} + \frac{u_r}{r} = \frac{1}{2}\varepsilon. \quad (5.59)$$

And with equation (5.53) it follows that

$$\frac{\partial u_z}{\partial z} = \frac{1}{2}\varepsilon. \quad (5.60)$$

Equations (5.58) – (5.60) were first given by Bear & Corapcioglu (1981), as a direct consequence of the plane stress model proposed by Verruijt (1969). It appears that in this model the volume strain consists of equal contributions from the horizontal strains and the vertical strains. It may be noted that in the classical theory the volume strain equals the vertical strain, because the horizontal strains are zero, by assumption. The complete solution of the problem considered here was also given by Bear & Corapcioglu (1981).

5.5.3 Pore pressure

The continuity equation of the pore fluid, or the storage equation, is

$$\alpha \frac{\partial \varepsilon}{\partial t} + S \frac{\partial p}{\partial t} = \frac{k}{\gamma_f} \left(\frac{\partial^2 p}{\partial r^2} + \frac{1}{r} \frac{\partial p}{\partial r} \right). \quad (5.61)$$

The volume strain can be eliminated from this equation using the relation (5.58). This gives

$$\frac{\partial p}{\partial t} = c'_v \left(\frac{\partial^2 p}{\partial r^2} + \frac{1}{r} \frac{\partial p}{\partial r} \right), \quad (5.62)$$

where c'_v is a modified consolidation coefficient,

$$c'_v = \frac{k(K + \frac{1}{3}G)}{\gamma_f[\alpha^2 + S(K + \frac{1}{3}G)]}. \quad (5.63)$$

Comparison with equation (5.12) shows that the only difference with the classical differential equation for the pore pressure is in the magnitude of the soil stiffness ($K + \frac{1}{3}G$ instead of $K + \frac{4}{3}G$).

It follows that the solution for the pore pressure is, in analogy with equation (5.22),

$$p = -\frac{Q\gamma_f}{4\pi kH} E_1(r^2/4c'_v t). \quad (5.64)$$

Because the soil in this case is less stiff ($K + \frac{1}{3}G < K + \frac{4}{3}G$), the dissipation process of the pore pressure will be somewhat slower than in the classical solution, given in equation (5.22), but the shape of the drawdown curve will be the same, see Figure 5.11.

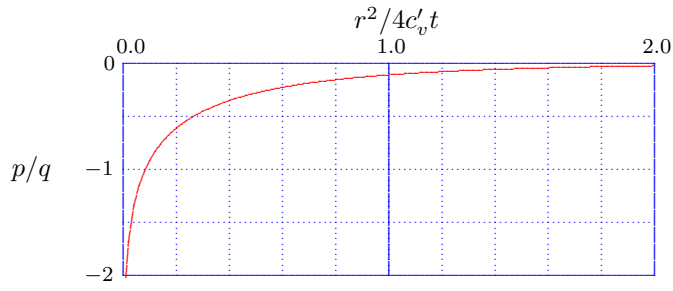

Figure 5.11: Well in infinite aquifer, plane stress model : pore pressure.

5.5.4 Displacements

For mathematical convenience the solution (5.64) is written in dimensionless form as

$$\frac{p}{q} = -\frac{1}{2} E_1(r^2/4c'_v t), \quad (5.65)$$

where, as before,

$$q = \frac{Q\gamma_f}{2\pi kH}. \quad (5.66)$$

With equation (5.58) the volume strain is found to be

$$\varepsilon = -\frac{1}{2}\alpha q' E_1(r^2/4c'_v t), \quad (5.67)$$

where

$$q' = \frac{q}{K + \frac{1}{3}G} = \frac{Q\gamma_f}{2\pi kH(K + \frac{1}{3}G)}. \quad (5.68)$$

Using equations (5.59) and (5.67) it follows that

$$\frac{\partial u_r}{\partial r} + \frac{u_r}{r} = \frac{1}{r} \frac{\partial(u_r r)}{\partial r} = -\frac{1}{4}\alpha q' E_1(r^2/4c'_v t). \quad (5.69)$$

Integration with respect to r gives

$$\frac{u_r}{H} = -\frac{1}{8}\alpha q' \frac{r}{H} \left\{ E_1(r^2/4c'_v t) + \frac{4c'_v t}{r^2} [1 - \exp(-r^2/4c'_v t)] \right\}, \quad (5.70)$$

where the integration constant has been determined such that for $r = 0$ the radial displacement is zero. It can easily be verified that equation (5.70) satisfies the differential equation (5.69).

Because for large values of z one may use the asymptotic approximation

$$z \rightarrow \infty : E_1(z) \approx \frac{\exp(-z)}{z}, \quad (5.71)$$

it follows that for large values of r

$$\frac{r^2}{4c'_v t} \rightarrow \infty : \frac{u_r}{r} \approx -\frac{1}{2}\alpha q' \frac{c'_v t}{r^2}, \quad (5.72)$$

where q' is given by equation (5.68). This means that at large distances from the well the horizontal displacements are proportional to $1/r$.

The vertical displacement can be determined from equations (5.60) and (5.67). This gives

$$\frac{\partial u_z}{\partial z} = -\frac{1}{4}\alpha q' E_1(r^2/4c'_v t). \quad (5.73)$$

Assuming that at the lower surface of the aquifer the vertical displacement is zero, and denoting the vertical displacement of the upper surface by w , it follows that

$$\frac{w}{H} = -\frac{1}{4}\alpha q' E_1(r^2/4c'_v t) = -\frac{\alpha Q\gamma_f}{8\pi kH(K + \frac{1}{3}G)} E_1(r^2/4c'_v t). \quad (5.74)$$

Comparison with equation (5.26) for the displacements in the Theis solution shows that the most important difference is that in this case, in which horizontal deformations are included, the vertical displacements are a factor 2 smaller. The other differences relate to the values of the coefficients, which are slightly different in the two cases.

5.5.5 Graphics

For the presentation of graphics it seems convenient to introduce dimensionless parameters as

$$\tau = c'_v t / H^2, \quad \rho = r / H, \quad \eta = -u_r / \alpha q' H, \quad \zeta = -w / \alpha q' H, \quad q' = \frac{Q \gamma_f}{2\pi k H (K + \frac{1}{3}G)}. \quad (5.75)$$

The equations for the horizontal and vertical displacements can now be written as

$$\eta = -u_r / \alpha q' H = \frac{1}{8} \rho \{ E_1(\rho^2 / 4\tau) + (4\tau / \rho^2) [1 - \exp(-\rho^2 / 4\tau)] \}, \quad (5.76)$$

$$\zeta = -w / \alpha q' H = \frac{1}{4} E_1(\rho^2 / 4\tau), \quad (5.77)$$

and the asymptotic approximation (5.72) can be written as $\rho^2 / (4\tau) \rightarrow \infty : \eta \approx \tau / (2\rho)$.

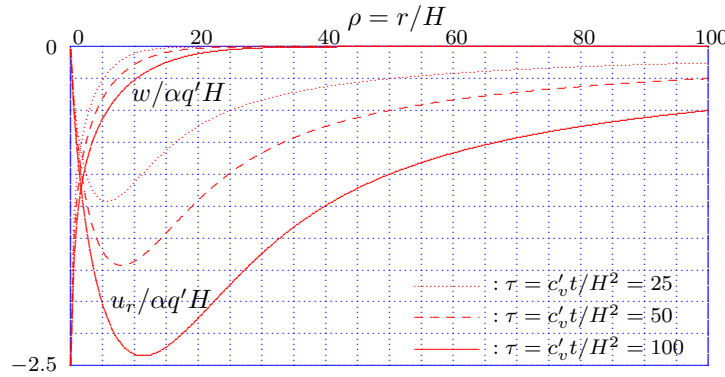

Figure 5.12: Well in infinite aquifer, plane stress model : displacements.

As an example the horizontal and vertical displacements are shown in Figure 5.12, for three values of time: $\tau = 25$, $\tau = 50$ and $\tau = 100$. It appears that there are indeed considerable horizontal displacements, much larger than the vertical displacements, in agreement with the notion that the flow of groundwater is horizontal and the friction character of this flow leads to considerable radial forces on the soil. It can be observed that for large values of $\rho = r/H$ the asymptotic values given above are indeed obtained. For instance, for $\rho = 100$ and $\tau = 100$, the figure indicates $\eta = 0.5$, and for $\rho = 50$ and $\tau = 100$, the figure indicates that $\eta = 1.0$. These values are in agreement with the asymptotic values given above. The results have also been compared with the results obtained from a numerical computation by Hsieh & Cooley (1995), and found to be in good agreement, with differences smaller than 2 %.

As mentioned before, in section 5.2, the solutions for a confined aquifer of infinite extent are of limited practical value, as the limiting behavior for $t \rightarrow \infty$ is singular. This means that there is no steady state solution: if pumping of the well continues, the pressure continues to drop, and the displacements continue to increase forever. More realistic types of problem will be considered in the next subsection for an aquifer of finite radial extent, and in section 5.6, in which the flow in a two-layered system is analyzed, with water supply to the pumped aquifer from an overlying layer in which the water level remains constant. It will appear that in these cases steady state solutions are indeed obtained for $t \rightarrow \infty$.

5.5.6 A well in a finite confined aquifer, plane stress model

As in the original Theis-Jacob approach the difficulty in the solution that it degenerates if time tends towards infinity, can be overcome if the aquifer does not extend towards infinity, but is bounded by a boundary with a prescribed water level, see Figure 5.13. The basic equations for this model have been given in the previous section. However, in general the integration constant f in equation (5.57) cannot be assumed to be zero,

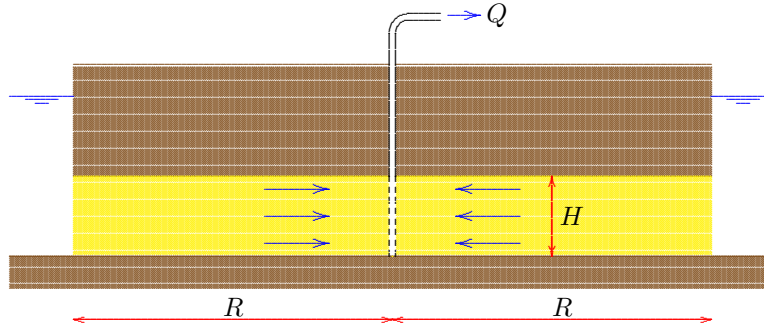

Figure 5.13: A well in a finite confined aquifer, plane stress model.

which was argued in that section to be a consequence of the infinite extent of the aquifer. For this reason the basic equations are derived anew.

The first equation follows from the assumption that the incremental vertical normal stress σ_{zz} is assumed to be zero. This can be expressed as

$$\sigma_{zz} = -(K - \frac{2}{3}G)\varepsilon - 2G\frac{\partial u_z}{\partial z} + \alpha p = 0. \quad (5.78)$$

For axially symmetric deformations the volume strain can be expressed as

$$\varepsilon = \frac{\partial u_r}{\partial r} + \frac{u_r}{r} + \frac{\partial u_z}{\partial z}. \quad (5.79)$$

It follows from equations (5.78) and (5.79) that

$$-(K + \frac{4}{3}G)\varepsilon + 2G\left(\frac{\partial u_r}{\partial r} + \frac{u_r}{r}\right) + \alpha p = 0. \quad (5.80)$$

The assumption that the incremental shear stress is assumed to be zero in this model, $\sigma_{zr} = 0$, leads to the following expression for the equilibrium equation in radial direction

$$\frac{\partial \sigma'_{rr}}{\partial r} + \frac{\sigma'_{rr} - \sigma'_{tt}}{r} + \alpha \frac{\partial p}{\partial r} = 0. \quad (5.81)$$

With Hooke's law this gives

$$-(K - \frac{2}{3}G)\frac{\partial \varepsilon}{\partial r} - 2G\frac{\partial}{\partial r}\left(\frac{\partial u_r}{\partial r} + \frac{u_r}{r}\right) + \alpha \frac{\partial p}{\partial r} = 0. \quad (5.82)$$

Integration with respect to r gives

$$-(K - \frac{2}{3}G)\varepsilon - 2G\left(\frac{\partial u_r}{\partial r} + \frac{u_r}{r}\right) + \alpha p = 2Gf, \quad (5.83)$$

where f is a dimensionless constant, depending upon z and t , and the factor $2G$ has been included to obtain that f is dimensionless. For an aquifer of relatively small thickness it can be assumed that f is a function of t only. However, for a finite aquifer it can not be assumed that $f = 0$. The value of this function will be determined from a condition on the radial stress at the boundary $r = R$.

It follows from addition of the two equations (5.80) and (5.83) that

$$(K + \frac{1}{3}G)\varepsilon = \alpha p - Gf. \quad (5.84)$$

Substraction of the two equations (5.80) and (5.83) gives

$$2(K + \frac{1}{3}G)\left(\frac{\partial u_r}{\partial r} + \frac{u_r}{r}\right) = (K + \frac{1}{3}G)(\varepsilon - f) = \alpha p - (K + \frac{4}{3}G)f, \quad (5.85)$$

and it follows that

$$2(K + \frac{1}{3}G)\frac{\partial u_z}{\partial z} = (K + \frac{1}{3}G)\left(\varepsilon - \frac{\partial u_r}{\partial r} - \frac{u_r}{r}\right) = (K + \frac{1}{3}G)(\varepsilon + f) = \alpha p + (K - \frac{2}{3}G)f. \quad (5.86)$$

These three equations are the generalization of the relations between the volume strain ε , the displacements u_r and u_z to the pressure p and the function f , as given in equations (5.58), (5.59) and (5.60) for the case of an infinite aquifer.

The continuity of the fluid is described by the storage equation,

$$\alpha \frac{\partial \varepsilon}{\partial t} + S \frac{\partial p}{\partial t} = \frac{k}{\gamma_f} \left(\frac{\partial^2 p}{\partial r^2} + \frac{1}{r} \frac{\partial p}{\partial r} \right). \quad (5.87)$$

Elimination of the volume strain ε from the two equations (5.84) and (5.87) gives

$$\frac{\partial p}{\partial t} = c'_v \left(\frac{\partial^2 p}{\partial r^2} + \frac{1}{r} \frac{\partial p}{\partial r} \right) + \beta G \frac{df}{dt}, \quad (5.88)$$

where c'_v is a modified consolidation coefficient, defined in equation (5.63), i.e.

$$c'_v = \frac{k(K + \frac{1}{3}G)}{\gamma_f[\alpha^2 + S(K + \frac{1}{3}G)]}, \quad (5.89)$$

and where

$$\beta = \frac{\alpha c'_v \gamma_f}{k(K + \frac{1}{3}G)} = \frac{\alpha}{\alpha^2 + S(K + \frac{1}{3}G)}. \quad (5.90)$$

It may be noted that in case of incompressible constituents $S = 0$ and therefore $\alpha = \beta = 1$.

Again, the solution can most conveniently be obtained using the Laplace transformation. Transformation of equation (5.88) gives

$$s\bar{p} = c'_v \left(\frac{d^2 \bar{p}}{dr^2} + \frac{1}{r} \frac{d\bar{p}}{dr} \right) + s\beta G \bar{f}, \quad (5.91)$$

where it has been assumed that the initial pore pressure, at the time that the well starts operating, is zero.

Equation (5.91) can also be written as

$$\frac{d^2 \bar{p}}{dr^2} + \frac{1}{r} \frac{d\bar{p}}{dr} - \frac{s}{c'_v} \{ \bar{p} - \beta G \bar{f} \}. \quad (5.92)$$

The solution of the differential equation (5.92) is

$$\bar{p} = \beta G \bar{f} + AI_0(r\sqrt{s/c'_v}) + BK_0(r\sqrt{s/c'_v}), \quad (5.93)$$

where A and B are constants.

The boundary conditions for the pore pressure are

$$r \rightarrow 0 : 2\pi r H \frac{k}{\gamma_f} \frac{d\bar{p}}{dr} = \frac{Q}{s}, \quad (5.94)$$

$$r = R : \bar{p} = 0, \quad (5.95)$$

where Q is the discharge of the well.

From the first boundary condition, equation (5.94), it follows that

$$B = -\frac{Q\gamma_f}{2\pi k H s}. \quad (5.96)$$

And the second boundary condition, equation (5.95), gives

$$\beta G \bar{f} + AI_0(R\sqrt{s/c'_v}) + BK_0(R\sqrt{s/c'_v}) = 0, \quad (5.97)$$

from which it follows that

$$A = -B \frac{K_0(R\sqrt{s/c'_v})}{I_0(R\sqrt{s/c'_v})} - \frac{\beta G \bar{f}}{I_0(R\sqrt{s/c'_v})}. \quad (5.98)$$

The Laplace transform of the pore pressure now is

$$\bar{p} = \beta G \bar{f} \left\{ 1 - \frac{I_0(r\sqrt{s/c'_v})}{I_0(R\sqrt{s/c'_v})} \right\} - \frac{Q\gamma_f}{2\pi k H s} \left\{ K_0(r\sqrt{s/c'_v}) - \frac{K_0(R\sqrt{s/c'_v})}{I_0(R\sqrt{s/c'_v})} I_0(r\sqrt{s/c'_v}) \right\}. \quad (5.99)$$

In this expression the value of \bar{f} is unknown at this stage of the analysis.

In the present model, assuming plane total stress, the volume strain ε and the displacements u_r and u_z are related to the pressure p and the function f by equations (5.84), (5.85) and (5.86). It follows from these equations that

$$(K + \frac{1}{3}G)\bar{\varepsilon} = \alpha\bar{p} - G\bar{f}, \quad (5.100)$$

$$2(K + \frac{1}{3}G)\frac{d(r\bar{u}_r)}{dr} = \alpha\bar{p}r - (K + \frac{4}{3}G)\bar{f}r, \quad (5.101)$$

$$2(K + \frac{1}{3}G)\frac{d\bar{u}_z}{dz} = \alpha\bar{p} + (K - \frac{2}{3}G)\bar{f}. \quad (5.102)$$

Elimination of \bar{p} from these equations, using equation (5.99), gives

$$(K + \frac{1}{3}G)\bar{\varepsilon} = \alpha\beta G \bar{f} \left\{ 1 - \frac{I_0(r\sqrt{s/c'_v})}{I_0(R\sqrt{s/c'_v})} \right\} - G\bar{f} - \frac{\alpha Q\gamma_f}{2\pi k H s} \left\{ K_0(r\sqrt{s/c'_v}) - \frac{K_0(R\sqrt{s/c'_v})}{I_0(R\sqrt{s/c'_v})} I_0(r\sqrt{s/c'_v}) \right\}, \quad (5.103)$$

$$2(K + \frac{1}{3}G)\frac{d(r\bar{u}_r)}{dr} = \alpha\beta G \bar{f} r \left\{ 1 - \frac{I_0(r\sqrt{s/c'_v})}{I_0(R\sqrt{s/c'_v})} \right\} - (K + \frac{4}{3}G)\bar{f}r - \frac{\alpha Q\gamma_f r}{2\pi k H s} \left\{ K_0(r\sqrt{s/c'_v}) - \frac{K_0(R\sqrt{s/c'_v})}{I_0(R\sqrt{s/c'_v})} I_0(r\sqrt{s/c'_v}) \right\}, \quad (5.104)$$

$$2(K + \frac{1}{3}G)\frac{d\bar{u}_z}{dz} = \alpha\beta G \bar{f} \left\{ 1 - \frac{I_0(r\sqrt{s/c'_v})}{I_0(R\sqrt{s/c'_v})} \right\} + (K - \frac{2}{3}G)\bar{f} - \frac{\alpha Q\gamma_f}{2\pi k H s} \left\{ K_0(r\sqrt{s/c'_v}) - \frac{K_0(R\sqrt{s/c'_v})}{I_0(R\sqrt{s/c'_v})} I_0(r\sqrt{s/c'_v}) \right\}. \quad (5.105)$$

The Laplace transform of the radial displacement can be determined by integrating the expression (5.104), using the relations (Abramowitz & Stegun, 1964, 9.6.28)

$$\frac{d}{dz} \{ z I_1(az) \} = az I_0(az), \quad \frac{d}{dz} \{ z K_1(az) \} = -az K_0(az), \quad (5.106)$$

so that

$$\int r I_0(r\sqrt{s/c'_v}) dr = \frac{r I_1(r\sqrt{s/c'_v})}{\sqrt{s/c'_v}} + C, \quad \int r K_0(r\sqrt{s/c'_v}) dr = -\frac{r K_1(r\sqrt{s/c'_v})}{\sqrt{s/c'_v}} + D, \quad (5.107)$$

where C and D are integration constants. It follows that

$$(K + \frac{1}{3}G)\bar{u}_r = \alpha\beta G \bar{f} \left\{ \frac{1}{4}r - \frac{I_1(r\sqrt{s/c'_v})}{2\sqrt{s/c'_v} I_0(R\sqrt{s/c'_v})} \right\} - \frac{1}{4}(K + \frac{4}{3}G)\bar{f}r + \frac{\alpha Q\gamma_f}{4\pi k H s \sqrt{s/c'_v}} \left\{ K_1(r\sqrt{s/c'_v}) - \frac{1}{r\sqrt{s/c'_v}} + \frac{K_0(R\sqrt{s/c'_v})}{I_0(R\sqrt{s/c'_v})} I_1(r\sqrt{s/c'_v}) \right\}, \quad (5.108)$$

where the integration constants have been determined so that the radial displacement at the origin is zero.

It follows from equation (5.102) that the Laplace transform of the vertical strain is independent of z so that the vertical displacement varies linearly over the depth of the aquifer. Assuming that the base of the aquifer is rigid, it follows that the vertical displacement at the top of the aquifer is

$$(K + \frac{1}{3}G)\bar{w} = \frac{1}{2}\alpha\beta G\bar{f}H\left\{1 - \frac{I_0(r\sqrt{s/c'_v})}{I_0(R\sqrt{s/c'_v})}\right\} + \frac{1}{2}(K - \frac{2}{3}G)\bar{f}H - \frac{\alpha Q\gamma_f}{4\pi ks}\left\{K_0(r\sqrt{s/c'_v}) - \frac{K_0(R\sqrt{s/c'_v})}{I_0(R\sqrt{s/c'_v})}I_0(r\sqrt{s/c'_v})\right\}. \quad (5.109)$$

The only remaining unknown parameter in the solution now is the constant \bar{f} , which can be determined from the condition that the boundary $r = R$ is free of radial stress. Because the pore pressure at this boundary has already been required to be zero, it follows that the effective stress $\sigma'_{rr} = 0$ for $r = R$. The general expression for this effective stress is

$$\sigma'_{rr} = -(K - \frac{2}{3}G)\varepsilon - 2G\frac{\partial u_r}{\partial r} = -(K + \frac{4}{3}G)\varepsilon + 2G\frac{\partial u_z}{\partial z} + 2G\frac{u_r}{r}. \quad (5.110)$$

With equations (5.103), (5.105) and (5.108) it follows that

$$r = R : (K + \frac{1}{3}G)\bar{\varepsilon} = -G\bar{f}, \quad (5.111)$$

$$r = R : (K + \frac{1}{3}G)\frac{d\bar{u}_z}{dz} = \frac{1}{2}(K - \frac{2}{3}G)\bar{f}, \quad (5.112)$$

$$r = R : (K + \frac{1}{3}G)\frac{\bar{u}_r}{r} = \frac{1}{4}\alpha\beta G\bar{f}\left\{1 - \frac{2I_1(R\sqrt{s/c'_v})}{R\sqrt{s/c'_v}I_0(R\sqrt{s/c'_v})}\right\} - \frac{1}{4}(K + \frac{4}{3}G)\bar{f} - \frac{\alpha Q\gamma_f}{4\pi kHR^2s^2/c'_v}\left\{1 - \frac{1}{I_0(R\sqrt{s/c'_v})}\right\}, \quad (5.113)$$

where use has been made of the Wronskian (Abramowitz & Stegun, 1964, 9.6.15)

$$I_0(z)K_1(z) + I_1(z)K_0(z) = 1/z. \quad (5.114)$$

The condition that for $r = R$ the radial stress is zero, $\sigma'_{rr} = 0$, leads to

$$\bar{f}\left\{\frac{3K}{G} + \alpha\beta\left[1 - \frac{2I_1(R\sqrt{s/c'_v})}{R\sqrt{s/c'_v}I_0(R\sqrt{s/c'_v})}\right]\right\} = \frac{\alpha Q\gamma_f}{\pi kHGR^2s^2/c'_v}\left\{1 - \frac{1}{I_0(R\sqrt{s/c'_v})}\right\}. \quad (5.115)$$

From this equation the value of the parameter \bar{f} can be determined, and then the pore pressure and the displacements can be calculated.

The inverse Laplace transform of the variables will be determined using the Talbot method. For this purpose it is convenient to introduce the dimensionless parameters

$$\tau = c'_v t/R^2, \quad \sigma = R^2 s/c'_v, \quad v = p/q, \quad \rho = r/R, \quad \eta = (K + \frac{1}{3}G)u_r/qR, \quad \zeta = (K + \frac{1}{3}G)w/qH, \quad (5.116)$$

where, as before,

$$q = \frac{Q\gamma_f}{2\pi kH}. \quad (5.117)$$

The Laplace transform \bar{f} can be expressed into the dimensionless variables σ and τ as

$$\bar{f} = \int_0^\infty f \exp(-st)dt = \frac{R^2}{c'_v} \int_0^\infty f \exp(-\sigma\tau)d\tau = \frac{R^2}{c'_v} \tilde{f}, \quad (5.118)$$

where \tilde{f} is the modified Laplace transform of f in terms of the dimensionless variables σ and τ . Equation (5.115) can now be written as

$$\frac{G\tilde{f}}{q}\left\{\frac{3K}{G} + \alpha\beta\left[1 - \frac{2I_1(\sqrt{\sigma})}{\sqrt{\sigma}I_0(\sqrt{\sigma})}\right]\right\} = \frac{2\alpha}{\sigma^2}\left[1 - \frac{1}{I_0(\sqrt{\sigma})}\right]. \quad (5.119)$$

From this equation the original parameter f can be determined, using the Talbot method for inversion of the Laplace transform. Then the pore pressure and the two displacement components can be determined.

It is interesting to note that the limiting value of the function f for $\tau \rightarrow \infty$ can be determined using the theorem (Carslaw & Jaeger, 1948) that

$$\lim_{\tau \rightarrow \infty} f = \lim_{\sigma \rightarrow 0} \sigma \tilde{f}. \quad (5.120)$$

Using the approximations $x \rightarrow 0 : I_0(\sqrt{\sigma}) = 1 + \frac{1}{4}\sigma, I_1(\sqrt{\sigma}) = \frac{1}{2}\sqrt{\sigma}$ it follows from equation (5.119) that

$$\lim_{\tau \rightarrow \infty} f = 0. \quad (5.121)$$

5.5.7 Pore pressure

The Laplace transform of the pore pressure has been given in equation (5.99). With $\tilde{v} = R^2 \bar{v}/c'_v$ and $\tilde{f} = R^2 \bar{f}/c'_v$ this can be expressed in terms of dimensionless variables as

$$\tilde{v} = \frac{\tilde{p}}{q} = \frac{\beta G \tilde{f}}{q} \left\{ 1 - \frac{I_0(\rho\sqrt{\sigma})}{I_0(\sqrt{\sigma})} \right\} - \frac{1}{\sigma} \left\{ K_0(\rho\sqrt{\sigma}) - \frac{K_0(\sqrt{\sigma})}{I_0(\sqrt{\sigma})} I_0(\rho\sqrt{\sigma}) \right\}. \quad (5.122)$$

Figure 5.14 shows the pore pressure as a function of r/R for three values of dimensionless time. For this figure the parameters in the solution have been chosen as $K/G = 1$ (or $\nu = \frac{1}{8}$) and $\beta = 1$. The figure also shows the values of the steady state solution, by the black dots. This steady state solution, obtained for $t \rightarrow \infty$, is, using equation (5.121),

$$\tau \rightarrow \infty : \frac{p}{q} = \ln(r/R). \quad (5.123)$$

This is the same as in the Theis-Jacob model, see equation (5.36), and its derivation. For the evaluation of

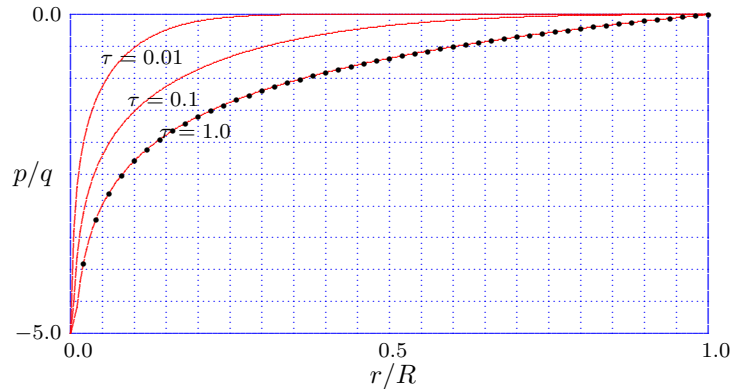

Figure 5.14: Well in finite confined aquifer, plane stress model : pore pressure.

the inverse Laplace transform by the Talbot method it is necessary in this case to determine the values of the Bessel functions I_0 and K_0 for complex values of the argument. These can be calculated using the algorithms given in section 5.7.

5.5.8 Radial displacement

In terms of the modified Laplace transforms, with $\tilde{f} = R^2 \bar{f}/c'_v$ and $\tilde{\eta} = R^2 \bar{\eta}/c'_v$ equation (5.108) can be written as

$$\tilde{\eta} = \left\{ \alpha \beta \left[\frac{1}{4} \rho - \frac{I_1(\rho\sqrt{\sigma})}{2\sqrt{\sigma} I_0(\sqrt{\sigma})} \right] - \frac{1}{4} \rho \left(\frac{K}{G} + \frac{4}{3} \right) \right\} \frac{G \tilde{f}}{q} + \frac{\alpha}{2\sigma\sqrt{\sigma}} \left\{ K_1(\rho\sqrt{\sigma}) - \frac{1}{\rho\sqrt{\sigma}} + \frac{K_0(\sqrt{\sigma})}{I_0(\sqrt{\sigma})} I_1(\rho\sqrt{\sigma}) \right\}. \quad (5.124)$$

Figure 5.15 shows the results of numerical calculations of the dimensionless horizontal displacement as a function of r/R , for three values of the dimensionless time parameter $\tau = c_v t/R^2$. Again the parameters in the solution have been chosen as $K/G = 1$ and $\alpha = \beta = 1$. The curve for $\tau = 1.0$ is almost equal to the steady state solution, as obtained by taking $\tau = 10$, shown in the figure by black dots. This is confirmed by plotting the horizontal displacements as a function of τ , for three values of r/R , see Figure 5.16. In this figure it can be seen that the value of $(K + \frac{1}{3}G)u_r/qR$ for $\tau = 1.0$ is indeed almost equal to the value for $\tau = 10.0$.

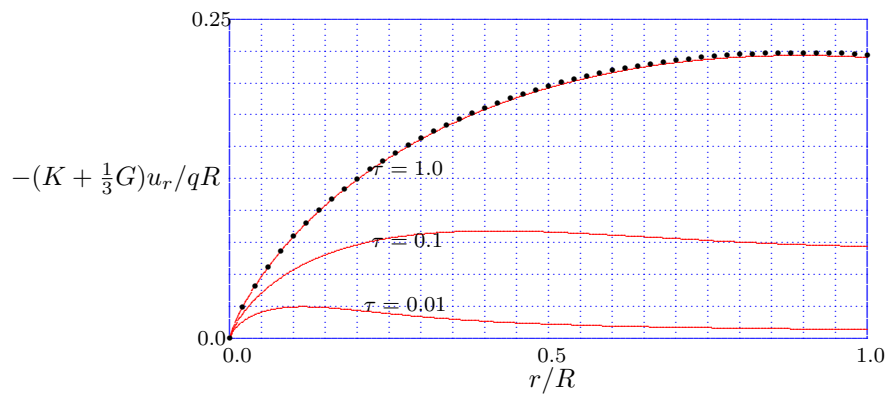

Figure 5.15: Well in finite confined aquifer, plane stress model : horizontal displacement.

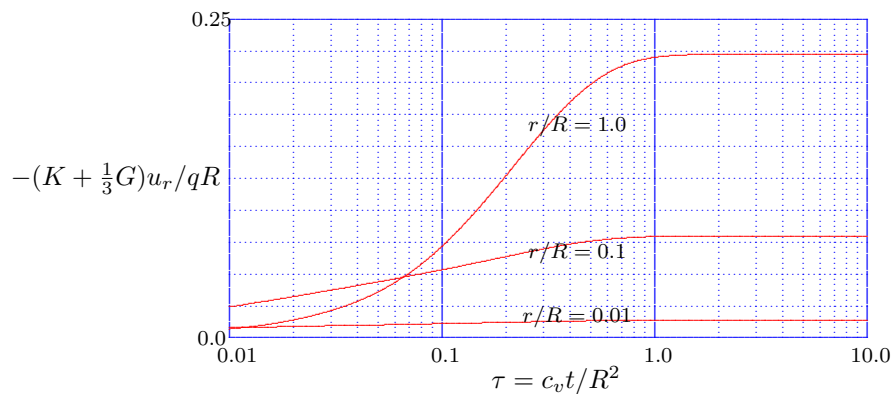

Figure 5.16: Well in finite confined aquifer, plane stress model : horizontal displacement.

5.5.9 Vertical displacement

The vertical displacement has been given in equation (5.109). In terms of the modified Laplace transforms, with $\tilde{f} = R^2 \bar{f} / c'_v$ and $\tilde{\zeta} = R^2 \bar{\zeta} / c'_v$ this equation can be written as

$$\tilde{\zeta} = \left\{ \frac{1}{2} \alpha \beta \left[1 - \frac{I_0(\rho \sqrt{\sigma})}{I_0(\sqrt{\sigma})} \right] + \left(\frac{K}{2G} - \frac{1}{3} \right) \right\} \frac{G \tilde{f}}{q} - \frac{\alpha}{2\sigma} \left\{ K_0(\rho \sqrt{\sigma}) - \frac{K_0(\sqrt{\sigma})}{I_0(\sqrt{\sigma})} I_0(\rho \sqrt{\sigma}) \right\}. \quad (5.125)$$

Results of a numerical inversion of this Laplace transform, using the Talbot method, are shown as a function of r/R , for three values of the time parameter $\tau = c_v t / R^2$ in Figure 5.17. The black dots indicate the steady state solution, calculated by taking $\tau = 10$.

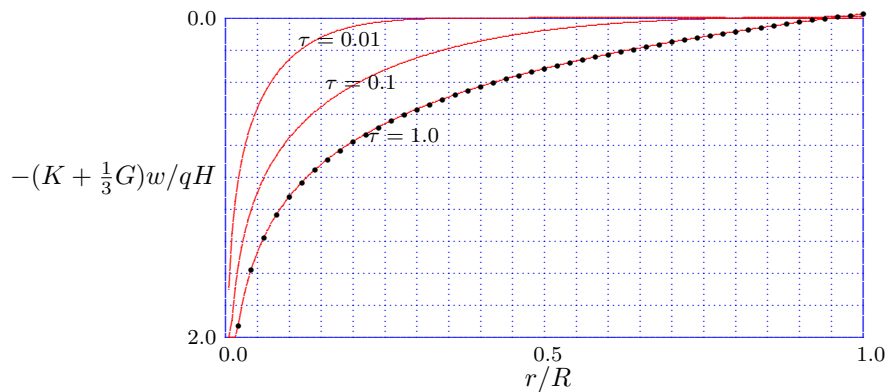

Figure 5.17: Well in finite confined aquifer, plane stress model : vertical displacement.

state solution, calculated by taking $\tau = 10$.

5.6 A well in a leaky aquifer, plane stress model

Problems of groundwater flow to a well in a leaky aquifer (sometimes denoted as a semi-confined aquifer) can also be analyzed using the plane total stress model introduced in section 5.5. In this section some of such problems will be considered, for a well in an aquifer of infinite extent and for a well in a finite aquifer.

5.6.1 A well in an infinite leaky aquifer, plane stress model

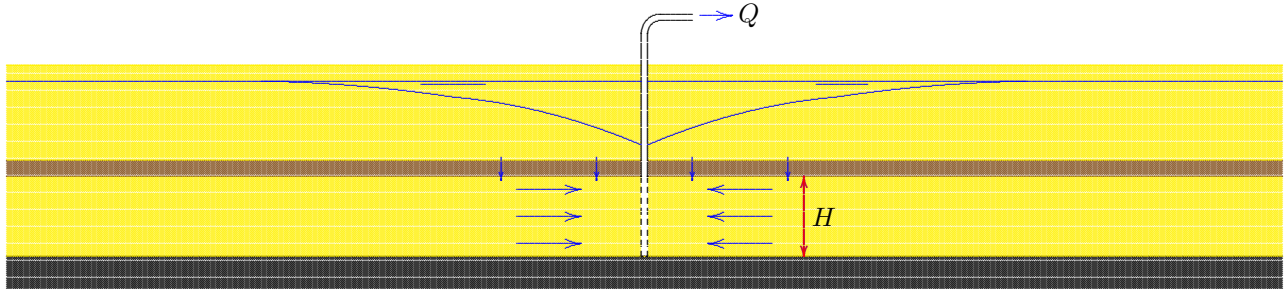

Figure 5.18: A well in a leaky aquifer.

Figure 5.18 illustrates the problem of a well in a leaky aquifer of infinite radial extent. The aquifer extracts water from the layer above it, in which the water level is kept constant.

Assuming that the (incremental) total stresses on a horizontal plane are zero, $\sigma_{zz} = \sigma_{zr} = 0$, it again follows, from an analysis of equilibrium and Hooke's law, that

$$(K + \frac{1}{3}G)\varepsilon = \alpha p, \quad (5.126)$$

$$\frac{\partial u_r}{\partial r} + \frac{u_r}{r} = \frac{1}{2}\varepsilon, \quad (5.127)$$

$$\frac{\partial u_z}{\partial z} = \frac{1}{2}\varepsilon. \quad (5.128)$$

The equation of conservation of fluid mass now is, adding a term representing leakage to equation (5.61),

$$\alpha \frac{\partial \varepsilon}{\partial t} + S \frac{\partial p}{\partial t} = \frac{k}{\gamma_f} \left(\frac{\partial^2 p}{\partial r^2} + \frac{1}{r} \frac{\partial p}{\partial r} - \frac{p}{\lambda^2} \right), \quad (5.129)$$

where $k/\gamma_f = \kappa/\mu$ and $\lambda^2 = kHd/k'$. Here k is the hydraulic conductivity of the aquifer, k' is the hydraulic conductivity of the aquitard, H is the thickness of the aquifer, and d is the thickness of the aquitard. The factor $\gamma_f = \rho_f g$ is the volumetric weight of the fluid, the product of the fluid density ρ_f and the gravity constant g . The parameter λ is usually called the *leakage factor*. Because $k/k' \gg 1$ it can be expected that the order of magnitude of this leakage factor is 100 m, or even more.

It follows from equations (5.126) and (5.129) that the basic equation for the pore pressure in this case is

$$\frac{1}{c'_v} \frac{\partial p}{\partial t} = \frac{\partial^2 p}{\partial r^2} + \frac{1}{r} \frac{\partial p}{\partial r} - \frac{p}{\lambda^2}, \quad (5.130)$$

where c'_v is a modified consolidation coefficient,

$$c'_v = \frac{k(K + \frac{1}{3}G)}{\gamma_f[\alpha^2 + S(K + \frac{1}{3}G)]}. \quad (5.131)$$

For the case of a well of constant discharge, operating from $t = 0$, the boundary conditions are

$$r \rightarrow \infty : p = 0, \quad (5.132)$$

$$r \rightarrow 0 : 2\pi r H \frac{k}{\gamma_f} \frac{\partial p}{\partial r} = QH(t), \quad (5.133)$$

where Q is the discharge of the well, and $H(t)$ is Heaviside's unit step function.

Equation (5.130) was given and solved by Verruijt (1969). The equation is formally identical to the basic differential equation established and solved by Hantush & Jacob (1955), the only difference being in the value of the consolidation coefficient. The solution can most conveniently be obtained using the Laplace transform technique (Churchill, 1972). Applying the Laplace transformation

$$\bar{p} = \int_0^{\infty} p \exp(-st) dt, \quad (5.134)$$

to equation (5.130) gives

$$\frac{d^2 \bar{p}}{dr^2} + \frac{1}{r} \frac{d\bar{p}}{dr} - \omega^2 \bar{p} = 0, \quad (5.135)$$

where

$$\omega^2 = s/c'_v + 1/\lambda^2. \quad (5.136)$$

The solution of this equation, satisfying the Laplace transforms of the boundary conditions (5.132) and (5.133), is

$$\bar{p} = -\frac{Q\gamma_f}{2\pi kH} \frac{K_0(\omega r)}{s}. \quad (5.137)$$

The inverse Laplace transform of this expression can be obtained starting from the well known Laplace transform (see e.g. Abramowitz & Stegun, 1964, 29.3.120)

$$K_0(k\sqrt{s}) = \int_0^{\infty} \left\{ \frac{1}{2t} \exp(-k^2/4t) \right\} \exp(-st) dt. \quad (5.138)$$

Replacing s by $s + a$ gives

$$K_0(k\sqrt{s+a}) = \int_0^{\infty} \left\{ \frac{1}{2t} \exp(-k^2/4t - at) \right\} \exp(-st) dt. \quad (5.139)$$

Using the theorem that multiplication of the Laplace transform by a factor $1/s$ corresponds to integration over t of the original function gives

$$\frac{K_0(k\sqrt{s+a})}{s} = \int_0^{\infty} \left\{ \int_0^t \frac{1}{2\tau} \exp(-k^2/4\tau - a\tau) d\tau \right\} \exp(-st) dt. \quad (5.140)$$

Noting that the form of equation (5.137) can be obtained by writing $k = r/\sqrt{c'_v}$ and $a = c'_v/\lambda^2$ it follows that the inverse form of that equation is

$$p = -\frac{Q\gamma_f}{4\pi kH} \int_0^t \frac{\exp(-r^2/4c'_v\tau - c'_v\tau/\lambda^2)}{\tau} d\tau. \quad (5.141)$$

The solution can be brought into a more familiar form by the substitution $\tau = r^2/4c'_v y$. This gives

$$p = -\frac{Q\gamma_f}{4\pi kH} W(r^2/4c'_v t, r/\lambda), \quad (5.142)$$

where $W(x, a)$ is Hantush's well function (Hantush & Jacob, 1955),

$$W(x, a) = \int_x^{\infty} \frac{\exp(-y - a^2/4y)}{y} dy. \quad (5.143)$$

This function was tabulated by Hantush (1956). Values of this function can also be calculated with little difficulty by a computer function, see section 5.7.2. It may be noted that

$$\frac{\partial W(x, a)}{\partial x} = -\frac{\exp(-x - a^2/4x)}{x}. \quad (5.144)$$

Furthermore, the value for $x = 0$ is

$$W(0, a) = \int_0^\infty \frac{\exp(-y - a^2/4y)}{y} dy = 2K_0(a), \quad (5.145)$$

as can be obtained from a table of Laplace transforms, see e.g. Abramowitz & Stegun (1964), formula 29.3.120. It follows that the steady state solution, obtained for $t \rightarrow \infty$ is, from equations (5.142) and (5.145),

$$p = -\frac{Q\gamma_f}{2\pi kH} K_0(r/\lambda), \quad (5.146)$$

which is a well known result, that can be found in many texts on groundwater hydrology, see e.g. Bear (1979).

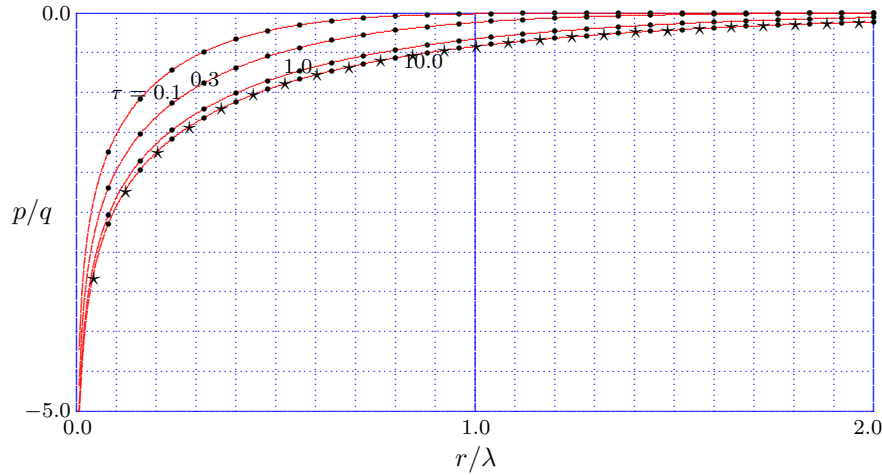

Figure 5.19: Well in infinite leaky aquifer, plane stress model : pore pressure.

The pore pressure is shown as a function of r/λ in Figure 5.19, for four values of $\tau = c'_v t/\lambda^2$. As before the pore pressure is shown as the dimensionless ratio p/q , with $q = Q\gamma_f/(2\pi kH)$. The analytical solution, as given by equation (5.142), is shown by the fully drawn red lines and the black dots indicate the results from a numerical inversion of the Laplace transform, equation (5.137), using Talbot's approximation. In terms of the dimensionless parameters $\tau = c'_v t/\lambda^2$, $\sigma = \lambda^2 s/c'_v$ and $\rho = r/\lambda$ this can be written as

$$\frac{\tilde{p}}{q} = -\frac{K_0(\rho\sqrt{1+\sigma})}{\sigma}, \quad (5.147)$$

where

$$\tilde{p} = \int_0^\infty p \exp(-\sigma\tau) d\tau. \quad (5.148)$$

It appears that the Talbot approximation is remarkably accurate.

The figure also shows the steady state solution, equation (5.146), by a series of stars. Actually the numerical values for $r/\lambda = 1$ and $\tau = 10$ are all very close, with errors less than 0.001 %.

5.6.2 Displacements

The displacements corresponding to the solution for the pore pressure (5.141) can be determined using the methodology developed by Bear & Corapcioglu (1981), based upon equations (5.126), (5.127) and (5.128), although some of their results will appear to need correction. The derivations are based on the Laplace transforms of these equations,

$$(K + \frac{1}{3}G)\bar{\varepsilon} = \alpha\bar{p} = -\frac{\alpha Q\gamma_f}{2\pi kH} \frac{K_0(\omega r)}{s}, \quad (5.149)$$

$$\frac{\partial \bar{u}_r}{\partial r} + \frac{\bar{u}_r}{r} = \frac{1}{2}\bar{\varepsilon}, \quad (5.150)$$

$$\frac{\partial \bar{u}_z}{\partial z} = \frac{1}{2} \bar{\varepsilon}. \quad (5.151)$$

It follows from equations (5.137) and (5.149) that

$$\frac{\partial \bar{u}_z}{\partial z} = \frac{1}{2} \bar{\varepsilon} = -\frac{\alpha Q \gamma_f}{4\pi k H (K + \frac{1}{3}G)} \frac{K_0(\omega r)}{s}. \quad (5.152)$$

5.6.3 Vertical displacement

It follows from equation (5.151) that the vertical strain is proportional to the volume change, and thus to the pore pressure. This means that the vertical displacements vary linearly over the depth of the aquifer. Assuming that the base of the aquifer is rigid, it follows that the vertical displacement at the top of the aquifer is

$$w = -\frac{\alpha Q \gamma_f}{8\pi k (K + \frac{1}{3}G)} W(r^2/4c'_v t, r/\lambda) = -\frac{\alpha Q \gamma_f}{8\pi k (K + \frac{1}{3}G)} \int_{r^2/4c'_v t}^{\infty} \frac{\exp(-y - r^2/4\lambda^2 y)}{y} dy. \quad (5.153)$$

The steady state limit is obtained by taking $t \rightarrow \infty$. This gives, with equation (5.145),

$$t \rightarrow \infty : w = -\frac{\alpha Q \gamma_f}{4\pi k (K + \frac{1}{3}G)} K_0(r/\lambda). \quad (5.154)$$

It may be noted that, if the small difference in the consolidation coefficients c_v and c'_v is ignored, this is one half of the vertical displacement obtained in the classical theory, in which the horizontal displacements are assumed to be zero.

To facilitate the graphical presentation of data it is again convenient to introduce dimensionless parameters, in this case $\rho = r/\lambda$ and $\tau = c'_v t/\lambda^2$. The solution (5.153) can then be written as

$$w = -\frac{\alpha Q \gamma_f}{8\pi k (K + \frac{1}{3}G)} W(\rho^2/4\tau, \rho). \quad (5.155)$$

For all positive values of time τ this expression has a singularity in the origin, for $\rho = 0$, caused by the concentrated discharge in the well.

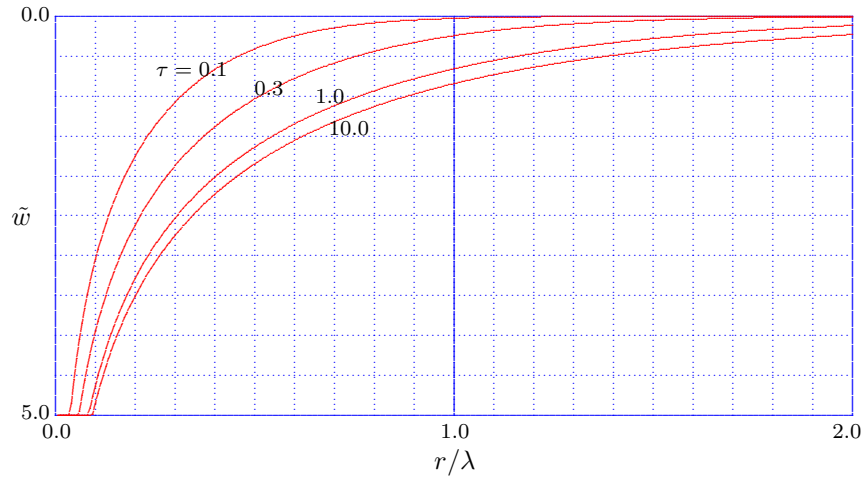

Figure 5.20: Well in infinite leaky aquifer, plane stress model : vertical displacement.

The vertical displacement is shown as a function of $\rho = r/\lambda$ in Figure 5.20, for four values of $\tau = c'_v t/\lambda^2$. The parameter \tilde{w} is the dimensionless quantity

$$\tilde{w} = -\frac{8\pi k (K + \frac{1}{3}G)}{\alpha Q \gamma_f} w. \quad (5.156)$$

The value $\tau = 10$ is large enough for the curve for $\tau = 10$ to be considered as representative for the steady state solution.

5.6.4 Radial displacement

From equation (5.150) it follows that the derivative of the radial displacement is

$$\frac{\partial(\bar{u}_r r)}{\partial r} = -\frac{\alpha Q \gamma_f}{4\pi k H (K + \frac{1}{3}G)} \frac{r K_0(\omega r)}{s}. \quad (5.157)$$

Because

$$\frac{d}{dr} \{r K_1(\omega r)\} = -\omega r K_0(\omega r), \quad (5.158)$$

(see for instance Abramowitz & Stegun, 1964, 9.6.28) it follows that

$$\bar{u}_r = \frac{\alpha Q \gamma_f}{4\pi k H (K + \frac{1}{3}G)} \left\{ \frac{K_1(\omega r)}{\omega s} + \frac{A}{r} \right\}, \quad (5.159)$$

where A is an integration constant. This constant can be determined by requiring that the radial displacement near the origin, for $r \rightarrow 0$, tends to zero. Because for small values of x the Bessel function $K_1(x)$ is, approximately,

$$x \rightarrow 0 : K_1(x) \approx 1/x, \quad (5.160)$$

it follows that

$$A = -\frac{1}{\omega^2 s} = -\frac{c'_v}{s(s + c'_v/\lambda^2)}. \quad (5.161)$$

Equation (5.159) can now be written as

$$\bar{u}_r = \frac{\alpha Q \gamma_f}{4\pi k H (K + \frac{1}{3}G)} \left\{ \frac{K_1(\omega r)}{\omega s} - \frac{c'_v}{r s (s + c'_v/\lambda^2)} \right\}, \quad (5.162)$$

The inverse Laplace transform of the first term in the expression (5.162) can be obtained starting from the well known Laplace transform (see e.g. Abramowitz & Stegun, 1964, 29.3.122),

$$\frac{K_1(m\sqrt{s})}{m\sqrt{s}} = \int_0^\infty \left\{ \frac{1}{m^2} \exp(-m^2/4t) \right\} \exp(-st) dt. \quad (5.163)$$

Replacing s by $s + a$ gives

$$\frac{K_1(m\sqrt{s+a})}{m\sqrt{s+a}} = \int_0^\infty \left\{ \frac{1}{m^2} \exp(-m^2/4t - at) \right\} \exp(-st) dt. \quad (5.164)$$

Using the theorem that multiplication of the Laplace transform by a factor $1/s$ corresponds to integration over t of the original function gives

$$\frac{K_1(m\sqrt{s+a})}{sm\sqrt{s+a}} = \int_0^\infty \left\{ \frac{1}{m^2} \int_0^t \exp(-m^2/4\tau - a\tau) d\tau \right\} \exp(-st) dt. \quad (5.165)$$

Noting that the form of the first term of equation (5.162) can be obtained by taking $m^2 = r^2/c'_v$ and $a = c'_v/\lambda^2$ it follows that the inverse form of that term is

$$u_{r-1} = \frac{\alpha Q \gamma_f c'_v}{4\pi r k H (K + \frac{1}{3}G)} \int_0^t \exp(-r^2/4c'_v\tau - c'_v\tau/\lambda^2) d\tau. \quad (5.166)$$

The second term of equation (5.162) can be decomposed as

$$\bar{u}_{r-2} = -\frac{\alpha Q \gamma_f}{4\pi r k H (K + \frac{1}{3}G)} \left\{ \frac{\lambda^2}{s} - \frac{\lambda^2}{s + c'_v/\lambda^2} \right\}. \quad (5.167)$$

Inversion of the Laplace transforms gives

$$u_{r-2} = -\frac{\alpha Q \gamma_f \lambda^2}{4\pi r k H (K + \frac{1}{3}G)} [1 - \exp(-c'_v t/\lambda^2)]. \quad (5.168)$$

It can easily be verified that for $r \rightarrow 0$ the first term, equation (5.166), reduces to the same form (except for the sign) as the second term, equation (5.168), so that the displacement in the origin is indeed zero.

The sum of the two contributions leads to the following equation for the radial displacement,

$$u_r = -\frac{\alpha Q \gamma_f}{4\pi r k H (K + \frac{1}{3}G)} \left\{ \lambda^2 [1 - \exp(-c'_v t / \lambda^2)] - c'_v \int_0^t \exp(-r^2 / 4c'_v \tau - c'_v \tau / \lambda^2) d\tau \right\} \quad (5.169)$$

It can easily be verified that the solution (5.169) indeed satisfies equation (5.127). It may be noted that the expression given by Bear & Corapcioglu (1981) for this radial displacement appears to be incorrect.

A graphical illustration of equation (5.169) may be constructed by introducing dimensionless variables defined as

$$\rho = r/\lambda, \quad \tau = c'_v t / \lambda^2, \quad y = c'_v \tau / \lambda^2, \quad q' = \frac{Q \gamma_f}{2\pi k H (K + \frac{1}{3}G)}, \quad \sigma = \lambda^2 s / c'_v, \quad \eta = u_r / (\alpha q' \lambda). \quad (5.170)$$

Using these substitutions the solution (5.169) can be written as

$$u_r = -\frac{1}{2} \alpha q' \lambda \frac{1}{\rho} \left\{ 1 - \exp(-\tau) - \int_0^\tau \exp(-y - \rho^2 / 4y) dy \right\}. \quad (5.171)$$

It can easily be verified that for $\rho \rightarrow 0$ and $\rho \rightarrow \infty$ the radial displacement tends towards zero, as required. Furthermore, for $\tau \rightarrow \infty$ the steady state limit is found to be

$$\tau \rightarrow \infty : u_r = -\frac{1}{2} \alpha q' \lambda \left\{ \frac{1}{\rho} - K_1(\rho) \right\}. \quad (5.172)$$

For $\rho = r/\lambda \rightarrow \infty$ both terms between the brackets in this expression tend towards zero. For $\rho = 5$ the first term between brackets is $1/\rho = 0.2$, and the second term is $K_1(\rho) = 0.0040$, indicating that the last term vanishes much faster than the first term. It may be noted that the radial displacements are negative if $Q > 0$, indicating a displacement in the direction of the well, that is in the direction of the flow, as could have been expected.

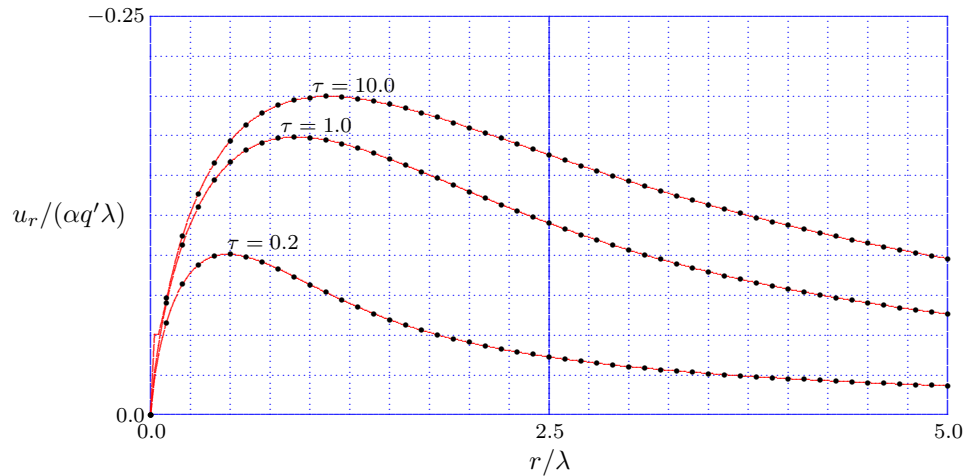

Figure 5.21: Well in infinite leaky aquifer, plane stress model : radial displacement.

The radial displacement is shown as a function of $\rho = r/\lambda$ in Figure 5.21, for three values of $\tau = c'_v t / \lambda^2$. The curve for $\tau = 10$ also practically describes the steady state values, as given by equation (5.172). It may be noted that for $\tau = 10$ and $\rho = 5$ the dimensionless radial displacement $u_r / (\alpha q' \lambda) = 0.1$, in agreement with the steady state value. For larger values of ρ it tends gradually towards zero. The black dots indicate

the values obtained using the numerical inversion of equation (5.162) by Talbot's method. For this purpose equation (5.162) can be written in dimensionless form as

$$\tilde{\eta} = \frac{\tilde{u}_r}{\alpha q' \lambda} = \frac{1}{2} \left\{ \frac{K_1(\rho \sqrt{\sigma + 1})}{\sigma \sqrt{\sigma + 1}} - \frac{1}{\rho \sigma (\sigma + 1)} \right\}, \quad (5.173)$$

where the modified Laplace transform is defined as

$$\tilde{\eta} = \int_0^{\infty} \eta \exp(-\sigma \tau) d\tau. \quad (5.174)$$

Again the agreement between numerical and analytical results is very good.

As mentioned before, the practical value of this solution is much larger than the solutions for a confined aquifer considered in earlier sections, because for this problem there exists a finite steady state limit for $t \rightarrow \infty$.

5.6.5 Steady flow in an infinite leaky aquifer

For the case of steady flow the solution has already been given in equation (5.146) as the limit of the general non-steady flow problem for $t \rightarrow \infty$. It may be illustrative to also derive this limit independently, directly from the basic equations. The pore pressure has been obtained in equation (5.146) as

$$p = -\frac{Q\gamma_f}{2\pi kH} K_0(r/\lambda). \quad (5.175)$$

This solution can also be written in dimensionless form as

$$\frac{p}{K + \frac{1}{3}G} = -q' K_0(r/\lambda). \quad (5.176)$$

The volume strain now is

$$\varepsilon = -\alpha q' K_0(r/\lambda), \quad (5.177)$$

It follows that the derivative of the radial displacement is

$$\frac{\partial(u_r r)}{\partial r} = -\frac{1}{2} \alpha q' r K_0(r/\lambda). \quad (5.178)$$

Integration gives

$$\frac{u_r}{H} = -\frac{1}{2} \alpha q' \frac{\lambda}{H} \left\{ \frac{\lambda}{r} - K_1(r/\lambda) \right\}. \quad (5.179)$$

This in agreement with equation (5.172).

The vertical strain is

$$\frac{\partial u_z}{\partial z} = -\frac{1}{2} \alpha q' K_0(r/\lambda). \quad (5.180)$$

It follows that the subsidence w of the surface $z = H$ is

$$\frac{w}{H} = -\frac{1}{2} \alpha q' K_0(r/\lambda), \quad (5.181)$$

which is in agreement with the limit obtained in equation (5.154).

Figure 5.22 shows the radial and vertical displacements as a function of $\rho = r/\lambda$, for the case $\lambda/H = 20$. The radial displacements are linearly dependent upon the value of λ/H . It appears that the radial displacements are considerably larger than the vertical displacements, except in the immediate vicinity of the well. At infinity ($r/\lambda \rightarrow \infty$) they both tend towards zero.

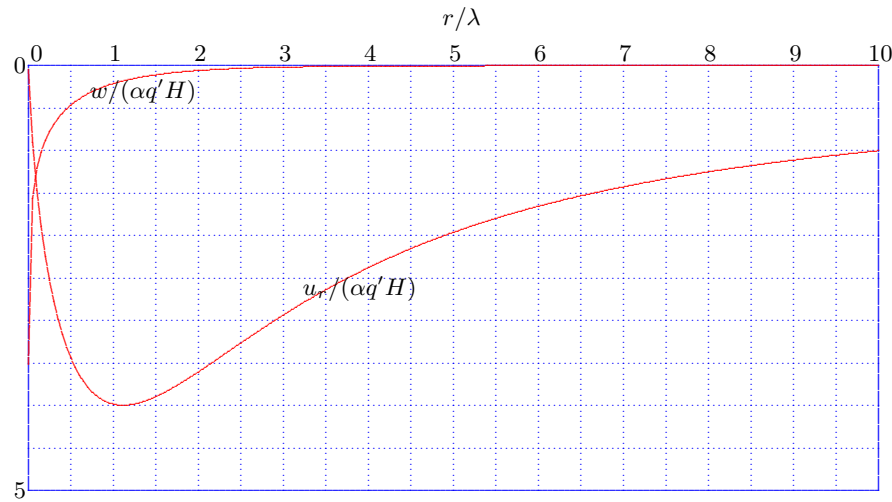

Figure 5.22: Radial and vertical displacements in a leaky aquifer, $\lambda/H = 20$.

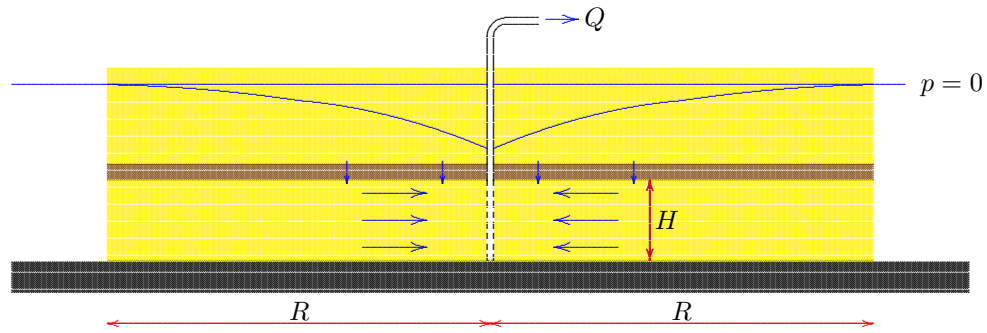

Figure 5.23: A well in a finite leaky aquifer.

5.6.6 A well in a finite leaky aquifer, plane stress model

This section considers the flow to a well in a finite leaky aquifer, see Figure 5.23. From the time $t = 0$ a well of discharge Q is operating in the aquifer. This well extracts water from the surrounding boundary and also by leakage from the upper layer. The groundwater head in that upper layer is maintained, by natural or artificial surface supply. The outer boundary is assumed to be a circle of radius R , along which the groundwater head remains constant. All pressures are considered with respect to that level. The permeability in the aquifer is k , and its thickness is H . The permeability of the layer separating the aquifer from the top layer (the aquiclude) is k' and its thickness is d .

The model for the analysis of the non-steady flow in the aquifer is a simplified version of Biot's theory of poroelasticity (Biot, 1941), in which the soil deforms under the conditions of plane total stress (Verruijt, 1969).

5.6.7 Basic equations

The basic equations for the deformations in a finite leaky aquifer are, in the case of plane total stress, with $\sigma_{zz} = 0$ and $\sigma_{zr} = 0$,

$$(K + \frac{1}{3}G)\varepsilon = \alpha p - Gf. \quad (5.182)$$

$$2(K + \frac{1}{3}G)(\frac{\partial u_r}{\partial r} + \frac{u_r}{r}) = (K + \frac{1}{3}G)(\varepsilon - f) = \alpha p - (K + \frac{4}{3}G)f, \quad (5.183)$$

$$2(K + \frac{1}{3}G)\frac{\partial u_z}{\partial z} = (K + \frac{1}{3}G)(\varepsilon - \frac{\partial u_r}{\partial r} - \frac{u_r}{r}) = (K + \frac{1}{3}G)(\varepsilon + f) = \alpha p + (K - \frac{2}{3}G)f. \quad (5.184)$$

These equations are the same as in the case of a finite confined aquifer, see equations (5.84), (5.85) and (5.86).

The continuity of the fluid is described by the storage equation, which in this case contains a term for the leakage,

$$\alpha \frac{\partial \varepsilon}{\partial t} + S \frac{\partial p}{\partial t} = \frac{k}{\gamma_f} \left(\frac{\partial^2 p}{\partial r^2} + \frac{1}{r} \frac{\partial p}{\partial r} \right) - \frac{k'}{\gamma_f} \frac{p}{Hd}, \quad (5.185)$$

where d is the thickness of the aquitard. The last term in equation (5.185) represents the flow into the aquifer by leakage. Elimination of the volume strain ε from the two equations (5.182) and (5.185) gives

$$\frac{\partial p}{\partial t} = c'_v \left(\frac{\partial^2 p}{\partial r^2} + \frac{1}{r} \frac{\partial p}{\partial r} - \frac{p}{\lambda^2} \right) + \beta G \frac{df}{dt}, \quad (5.186)$$

where c'_v is the consolidation coefficient,

$$c'_v = \frac{k(K + \frac{1}{3}G)}{\gamma_f[\alpha^2 + S(K + \frac{1}{3}G)]}, \quad (5.187)$$

λ is a leakage factor, defined by

$$\lambda^2 = Hd k / k', \quad (5.188)$$

and β is a dimensionless constant,

$$\beta = \frac{\alpha c'_v \gamma_f}{k(K + \frac{1}{3}G)} = \frac{\alpha}{\alpha^2 + S(K + \frac{1}{3}G)}. \quad (5.189)$$

It may be noted that in case of incompressible fluid and particles $S = 0$, and then $\alpha = \beta = 1$.

The boundary conditions for the flow and the deformation in the aquifer are

$$r \rightarrow 0 : 2\pi r \frac{kH}{\gamma_f} \frac{\partial p}{\partial r} = QH(t), \quad (5.190)$$

$$r = R : p = 0, \quad (5.191)$$

$$r \rightarrow 0 : u_r = 0, \quad (5.192)$$

$$r = R : \sigma_{rr} = 0. \quad (5.193)$$

The differential equation (5.186) can most conveniently be solved using the Laplace transformation technique. This gives

$$\frac{d^2 \bar{p}}{dr^2} + \frac{1}{r} \frac{d\bar{p}}{dr} - \omega^2 \bar{p} = -\frac{s\beta G}{c'_v} \bar{f}, \quad (5.194)$$

where

$$\omega^2 = s/c'_v + 1/\lambda^2. \quad (5.195)$$

The general solution of equation (5.194) is

$$\bar{p} = \frac{s\beta G}{\omega^2 c'_v} \bar{f} + A I_0(\omega r) + B K_0(\omega r), \quad (5.196)$$

where $I_0(\omega r)$ and $K_0(\omega r)$ are the modified Bessel functions of order zero and the first and second kinds, respectively.

The constants A and B can be determined from the Laplace transforms of the boundary conditions (5.190) and (5.191). The Laplace transform of the pore pressure now is

$$\bar{p} = \frac{s\beta G}{\omega^2 c'_v} \bar{f} \left\{ 1 - \frac{I_0(\omega r)}{I_0(\omega R)} \right\} - \frac{Q\gamma_f}{2\pi k H s} \left\{ K_0(\omega r) - \frac{K_0(\omega R)}{I_0(\omega R)} I_0(\omega r) \right\}. \quad (5.197)$$

This equation is of the same form as in the case of a finite confined aquifer, see equation (5.99), but the parameter β is to be replaced by $s\beta/(\omega^2 c'_v) = \beta/(1 + c'_v/s\lambda^2)$, and the parameter $r\sqrt{s/c'_v}$ must be replaced by $\omega r = \rho\sqrt{\sigma + m^2}$, where $\rho = r/R$, $\sigma = R^2 s/c'_v$, and m is an additional dimensionless parameter defined as

$$m = R/\lambda. \quad (5.198)$$

It follows that all further equations can be copied from the solution of the problem of a well in a finite confined aquifer, using the modified values of the parameters β and $r\sqrt{s/c'_v}$.

The function f is now to be determined from the equation

$$\frac{G\tilde{f}}{q} \left\{ \frac{3K}{G} + \frac{\alpha\beta}{1 + m^2/\sigma} \left[1 - \frac{2I_1(\sqrt{\sigma + m^2})}{\sqrt{\sigma}I_0(\sqrt{\sigma + m^2})} \right] \right\} = \frac{2\alpha}{\sigma^2} \left[1 - \frac{1}{I_0(\sqrt{\sigma + m^2})} \right]. \quad (5.199)$$

where the dimensionless parameters are defined as

$$\tau = c'_v t/R^2, \quad \sigma = R^2 s/c'_v, \quad v = p/q, \quad \rho = r/R, \quad \eta = (K + \frac{1}{3}G)u_r/qR, \quad \zeta = (K + \frac{1}{3}G)w/H, \quad m = R/\lambda, \quad (5.200)$$

and where, as before, $q = Q\gamma_f/(2\pi kH)$.

From equation (5.199) the original parameter f can be determined, using the Talbot method for inversion of the Laplace transform. Then the pore pressure and the two displacement components can be determined.

5.6.8 Pore pressure

The Laplace transform of the pore pressure has been given in equation (5.197). With $\tilde{v} = R^2 \bar{v}/c'_v$ and $\tilde{f} = R^2 \bar{f}/c'_v$ this can be expressed in terms of dimensionless variables as

$$\tilde{v} = \frac{\tilde{p}}{q} = \frac{\beta G \tilde{f}}{q(1 + m^2/\sigma)} \left\{ 1 - \frac{I_0(\rho\sqrt{\sigma + m^2})}{I_0(\sqrt{\sigma + m^2})} \right\} - \frac{1}{\sigma} \left\{ K_0(\rho\sqrt{\sigma + m^2}) - \frac{K_0(\sqrt{\sigma + m^2})}{I_0(\sqrt{\sigma + m^2})} I_0(\rho\sqrt{\sigma + m^2}) \right\}. \quad (5.201)$$

Figure 5.24 shows the pore pressure as a function of r/R for three values of dimensionless time, and for the case $R/\lambda = 0.1$ and $K/G = 1$. The figure also shows the values of the steady state solution, by the black dots. This steady state solution, obtained for $t \rightarrow \infty$, is the same as in the Theis-Jacob model.

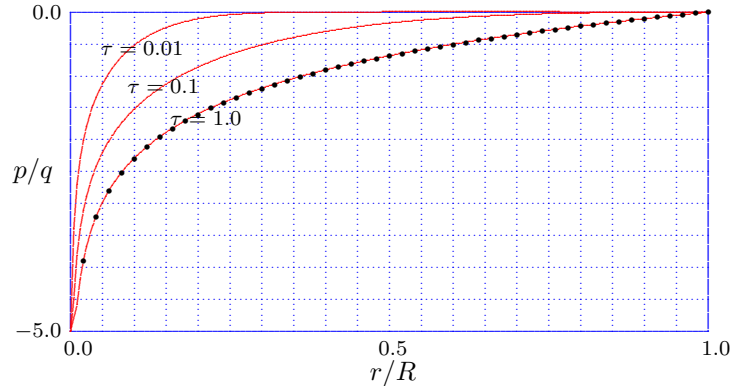

Figure 5.24: Well in finite leaky aquifer, plane stress model : pore pressure.

5.6.9 Radial displacement

The modified Laplace transform of the horizontal displacement is, starting from equation (5.124),

$$\tilde{\eta} = \left\{ \frac{\alpha\beta}{1 + m^2/\sigma} \left[\frac{1}{4}\rho - \frac{I_1(\rho\sqrt{\sigma + m^2})}{2\sqrt{\sigma + m^2}I_0(\sqrt{\sigma + m^2})} \right] - \rho \left(\frac{K}{4G} + \frac{1}{3} \right) \right\} \frac{G\tilde{f}}{q} + \frac{\alpha}{2\sigma\sqrt{\sigma}} \left\{ K_1(\rho\sqrt{\sigma + m^2}) - \frac{1}{\rho\sqrt{\sigma + m^2}} + \frac{K_0(\sqrt{\sigma + m^2})}{I_0(\sqrt{\sigma + m^2})} I_1(\rho\sqrt{\sigma + m^2}) \right\}. \quad (5.202)$$

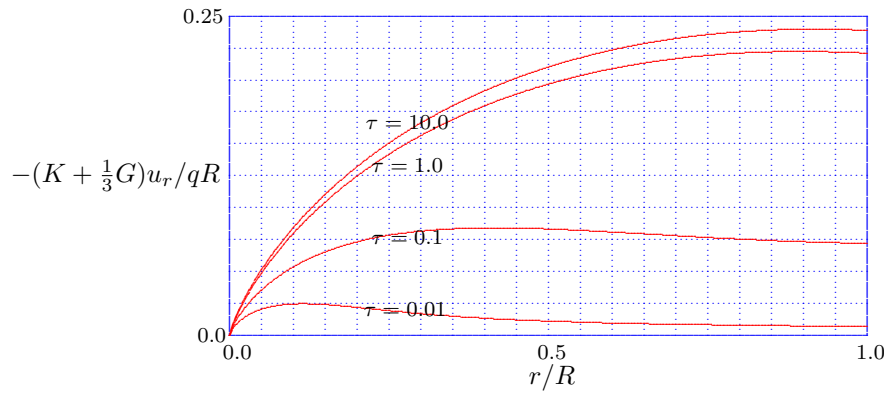

Figure 5.25: Well in finite leaky aquifer, plane stress model : horizontal displacement.

Figure 5.25 shows the results of numerical calculations of the dimensionless horizontal displacement as a function of r/R , for four values of the dimensionless time parameter $\tau = c_v t/R^2$, and assuming that $K/G = 1.0$ and $R/\lambda = 0.1$. For such a small value of R/λ the leakage factor is relatively large, indicating that the leakage is small, perhaps because the permeability of the aquiclude is small. Comparison with the results for a confined aquifer, see Figure 5.15, shows that the results for these two cases are not very different. If R/L is taken larger, say $R/L = 10$, the displacements are found to be much larger than those in Figure 5.25.

5.6.10 Vertical displacement

The modified Laplace transform of the vertical displacement is, starting from equation (5.125),

$$\begin{aligned} \tilde{\zeta} = & \left\{ \frac{\alpha\beta}{1+m^2/\sigma\lambda^2} \left[\frac{1}{2} - \frac{I_0(\rho\sqrt{\sigma+m^2})}{2I_0(\sqrt{\sigma+m^2})} \right] + \left(\frac{K}{2G} - \frac{1}{3} \right) \right\} \frac{G\tilde{f}}{q} - \\ & \frac{\alpha}{2\sigma} \left\{ K_0(\rho\sqrt{\sigma+m^2}) - \frac{K_0(\sqrt{\sigma+m^2})}{I_0(\sqrt{\sigma+m^2})} I_0(\rho\sqrt{\sigma+m^2}) \right\}. \end{aligned} \tag{5.203}$$

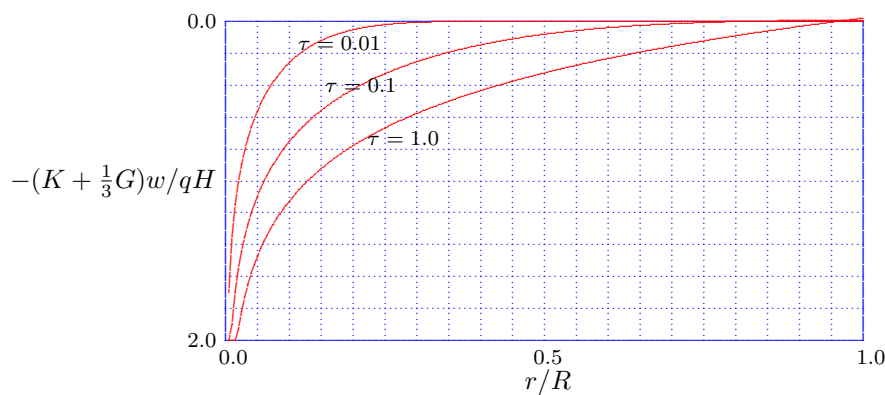

Figure 5.26: Well in finite confined aquifer, plane stress model : vertical displacement.

Figure 5.26 shows the results of numerical calculations of the dimensionless vertical displacement as a function of r/R , for three values of the dimensionless time parameter $\tau = c_v t/R^2$, and again assuming that $K/G = 1.0$ and $R/\lambda = 0.1$.

5.7 Some mathematical functions

In this section the algorithms for some mathematical functions used in this chapter are presented. These are the Bessel functions for complex arguments, and Hantush's well function.

5.7.1 Bessel functions for complex arguments

This subsection presents algorithms for the calculation of the modified Bessel functions $I_0(z)$, $K_0(z)$, $I_1(z)$ and $K_1(z)$ for complex values of z . The algorithms are based upon the series expansions given by Abramowitz & Stegun (1964, p. 375).

```
//-----
void BesselI0(complex z)
{
    double t,eps;complex a,f;int m,n;
    eps=0.000000001;n=1000;I0=a=1;f=z*z/4;m=t=1;
    while ((m<n)&&(t>eps)) {a*=f/(m*m);I0+=a;t=abs(a);m++;}
}
//-----
void BesselK0(complex z)
{
    double d,t,eps,gamma;complex a,f,i;int m,n;
    gamma=0.57721566490153;eps=0.000000001;n=1000;i=a=m=t=1;f=z*z/4;
    while ((m<n)&&(t>eps)) {a*=f/(m*m);i+=a;t=abs(a);m++;}
    K0=-(log(z/2)+gamma)*i;m=d=t=1;a=f;
    while ((m<n)&&(t>eps)) {K0+=d*a;m++;d+=1.0/m;a*=f/(m*m);t=abs(a);}
}
//-----
void BesselI1(complex z)
{
    double t,eps;complex a,f;int m,n;
    eps=0.000000001;n=1000;I1=a=m=t=1;f=z*z/4;
    while ((m<n)&&(t>eps)) {a*=f/(m*(m+1));I1+=a;t=abs(a);m++;}
    I1*=z/2;
}
//-----
double psi(int n)
{
    int k;double p,gamma;
    gamma=0.57721566490153;p=-gamma;
    if (n>1) for (k=1;k<n;k++) p+=1.0/k;
    return(p);
}
//-----
void BesselK1(complex z)
{
    double t,eps;complex a,f,i;int m,n;
    eps=0.000000001;n=1000;i=a=m=t=1;f=z*z/4;
    while ((m<n)&&(t>eps)) {a*=f/(m*(m+1));i+=a;t=abs(a);m++;}
    i*=z/2;K1=log(z/2)*i+1.0/z;m=0;t=1;a=z/4;
    while ((m<n)&&(t>eps)) {K1-=a*(psi(m+1)+psi(m+2));m++;a*=f/(m*(m+1));t=abs(a);}
}
//-----
```

5.7.2 Hantush's well function

This subsection gives a computer function (in C) to calculate Hantush's well function. Tables of this function are given by Hantush (1956), see also De Wiest (1965). The definition of the function is

$$W(x, a) = \int_x^\infty \frac{\exp(-y - a^2/4y)}{y} dy. \quad (5.204)$$

For $x > 0.01$ the integral is calculated using Simpson's integration method over the interval $x < y < 20$, assuming that for $y > 20$ the factor $\exp(-y)$ makes the integrand sufficiently small to disregard the contributions to the integral beyond $y = 20$. For $x < 0.01$ the integrand may become very large, so that a direct numerical integration, using constant integration intervals over the entire range, may become inaccurate. Therefore in this case the integration is separated into two parts : one for $0 < y < \infty$, for which an analytical expression is

available as $2K_0(a)$, and then subtracting the integral over the interval $0 < y < x$. Because the well function $W(x, a)$ and the Bessel function $K_0(x)$ are singular for $x = 0$, the value of x is restricted to $x > 0.000001$.

The algorithms for the calculation of the Bessel functions $I_0(x)$ and $K_0(x)$ for real arguments are from Abramowitz & Stegun (1964).

```
//-----
double IO(double u)
{
  double t,f,x,tt,s,c1,c2,c3,c4,c5,c6,c7,c8,c9;
  x=fabs(u);t=x/3.75;if (x<3.75)
  {
    tt=t*t;c1=3.5156229;c2=3.0899424;c3=1.2067492;c4=0.2659732;c5=0.0360768;c6=0.0045813;
    f=1+tt*(c1+tt*(c2+tt*(c3+tt*(c4+tt*(c5+tt*c6)))));
  }
  else
  {
    s=1/t;c1=0.39894228;c2=0.01328592;c3=0.00225319;c4=-0.00157565;
    c5=0.00916281;c6=-0.02057706;c7=0.02635537;c8=-0.01647633;c9=0.00392377;
    f=(c1+s*(c2+s*(c3+s*(c4+s*(c5+s*(c6+s*(c7+s*(c8+s*c9)))))))*exp(x)/sqrt(x);
  }
  return(f);
}
//-----
double K0(double u)
{
  double t,f,x,tt,s,c1,c2,c3,c4,c5,c6,c7,eps;
  eps=0.000001;x=fabs(u);if (x<eps) x=eps;
  if (x<2)
  {
    t=x/2;tt=t*t;c1=-0.57721566;c2=0.42278420;c3=0.23069756;c4=0.03488590;c5=0.00262698;c6=0.00010750;c7=0.00000740;
    f=-log(t)*IO(x)+c1+tt*(c2+tt*(c3+tt*(c4+tt*(c5+tt*(c6+tt*c7)))));
  }
  else
  {
    s=2/x;c1=1.25331414;c2=-0.07832358;c3=0.02189568;c4=-0.01062446;c5=0.00587872;c6=-0.00251540;c7=0.00053208;
    f=s*(c2+s*(c3+s*(c4+s*(c5+s*(c6+s*c7))))*exp(-x)/sqrt(x);
  }
  return(f);
}
//-----
double ff(double y,double a)
{
  double f,b;
  b=4*y/(a*a);if (b<0.02) f=0;else f=exp(-1/b)*exp(-y)/y;
  return(f);
}
//-----
double W(double x,double a)
{
  int i,n;double h,h3,y,f,xx,xa,eps,u;
  n=10000;xx=20;xa=0.01,eps=0.000001;u=x;if (u<eps) u=eps;f=0;if ((u>xa)&&(u<xx))
  {
    h=(xx-u)/(2*n);h3=h/3;
    for (i=1;i<=n;i++) {y=u+2*(i-1)*h;f+=h3*ff(y,a);y+=h;f+=4*h3*ff(y,a);y+=h;f+=h3*ff(y,a);}
  }
  else
  {
    f=2*K0(a);if (u>eps)
    {
      h=(u-eps)/(2*n);h3=h/3;
      for (i=1;i<=n;i++) {y=2*(i-1)*h+eps;f-=h3*ff(y,a);y+=h;f-=4*h3*ff(y,a);y+=h;f-=h3*ff(y,a);}
    }
  }
  return(f);
}
//-----
```

PLANE STRAIN HALF SPACE PROBLEMS

6.1 Introduction

This chapter presents the solution of problems of plane strain deformations in a poroelastic half space, with a given normal load on the surface, see Figure 6.1. The solution method uses the displacement functions introduced by McNamee & Gibson (1960), with the functions being generalized to take into account the compressibility of the pore fluid and the solid particles, see Verruijt (1971) and Detournay & Cheng (1993). The basic solutions could also be obtained by directly solving the three basic differential equations, expressed into the two displacement components and the pore pressure, but this seems to be less convenient.

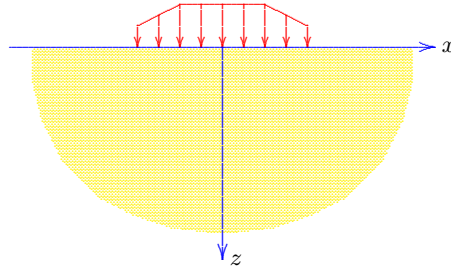

Figure 6.1: Half space with surface load.

As an example the solution for a strip load on a half plane loaded by a uniform load over a circular area, will be considered. Solutions for this problem were given by McNamee & Gibson (1960), but these were elaborated only for some characteristics of the surface displacements, and for incompressible constituents. In this paper the solution is extended to a more general porous medium, with compressible constituents, and solutions are given for the pore pressure and the stress components throughout the half space.

As in the original paper by McNamee & Gibson (1960) the problem is solved using Laplace and Fourier transformations. It appears that the inverse Laplace transform can be obtained in closed form for certain quantities, but for the components of total stress a numerical inversion method is needed. The inverse Fourier transforms are also determined numerically.

Notations and sign conventions are as defined in Chapter 1. This means that compressive stresses are considered positive.

6.2 Plane strain deformations

6.2.1 Basic equations

The basic equations of plane strain consolidation for a homogeneous elastic porous medium are the storage equation and the two equations of equilibrium in the two coordinate directions x and z .

In the two-dimensional case of plane strain deformations the storage equation (1.36) reduces to

$$\alpha \frac{\partial \varepsilon}{\partial t} + S \frac{\partial p}{\partial t} = \frac{k}{\gamma_f} \left(\frac{\partial^2 p}{\partial x^2} + \frac{\partial^2 p}{\partial z^2} \right), \quad (6.1)$$

where k is the permeability of the porous material, γ_f is the volumetric weight of the fluid, p is the pore pressure, and α is the Biot coefficient,

$$\alpha = 1 - C_s / C_m, \quad (6.2)$$

where C_s is the compressibility of the particle material, and C_m is the compressibility of the porous medium as a whole, the inverse of its compression modulus, $C_m = 1/K$. Finally, the parameter S is the storativity, defined as

$$S = nC_f + (\alpha - n)C_s, \quad (6.3)$$

where C_f is the compressibility of the pore fluid.

The two equations of equilibrium are, in terms of the total stresses,

$$\frac{\partial \sigma_{xx}}{\partial x} + \frac{\partial \sigma_{zx}}{\partial z} = 0, \quad (6.4)$$

$$\frac{\partial \sigma_{xz}}{\partial x} + \frac{\partial \sigma_{zz}}{\partial z} = 0. \quad (6.5)$$

The total stresses can be decomposed into the effective stresses and the pore pressure by Terzaghi's relations,

$$\sigma_{xx} = \sigma'_{xx} + \alpha p, \quad \sigma_{xz} = \sigma'_{xz}, \quad (6.6)$$

$$\sigma_{zz} = \sigma'_{zz} + \alpha p, \quad \sigma_{zx} = \sigma'_{zx}, \quad (6.7)$$

The effective stresses can be expressed into the displacement components u_x and u_z by Hooke's law for the case of plane strain ($u_y = 0$),

$$\sigma'_{xx} = -(K - \frac{2}{3}G)\varepsilon - 2G\frac{\partial u_x}{\partial x}, \quad (6.8)$$

$$\sigma'_{zz} = -(K - \frac{2}{3}G)\varepsilon - 2G\frac{\partial u_z}{\partial z}, \quad (6.9)$$

$$\sigma'_{xz} = \sigma'_{zx} = -G\left(\frac{\partial u_x}{\partial z} + \frac{\partial u_z}{\partial x}\right), \quad (6.10)$$

where K and G are the compression modulus and the shear modulus of the porous medium, the displacement components in the directions of the coordinates x and z are denoted as u_x and u_z , and the volume strain is $\varepsilon = \partial u_x / \partial x + \partial u_z / \partial z$. The sign convention for the stresses is that compressive stresses are considered positive (as for the pore pressure), which is standard practice in soil mechanics. For this reason the expressions for Hooke's law, equations (6.8) – (6.10) contain a minus sign.

The compression modulus K and the shear modulus G are related to the Lamé constants λ and μ , which are commonly used in the theory of elasticity, by the relations

$$\lambda = K - \frac{2}{3}G, \quad G = \mu. \quad (6.11)$$

The equations of equilibrium can be expressed in terms of the displacements and the pore pressure as

$$(K + \frac{1}{3}G)\frac{\partial \varepsilon}{\partial x} + G\nabla^2 u_x - \alpha\frac{\partial p}{\partial x} = 0, \quad (6.12)$$

$$(K + \frac{1}{3}G)\frac{\partial \varepsilon}{\partial z} + G\nabla^2 u_z - \alpha\frac{\partial p}{\partial z} = 0. \quad (6.13)$$

Following McNamee & Gibson (1960) these equations can also be written in a more convenient form as

$$(2\eta - 1)G\frac{\partial \varepsilon}{\partial x} + G\nabla^2 u_x - \alpha\frac{\partial p}{\partial x} = 0, \quad (6.14)$$

$$(2\eta - 1)G\frac{\partial \varepsilon}{\partial z} + G\nabla^2 u_z - \alpha\frac{\partial p}{\partial z} = 0, \quad (6.15)$$

where

$$\eta = \frac{1 - \nu}{1 - 2\nu} = \frac{K + \frac{4}{3}G}{2G}. \quad (6.16)$$

It will appear to be mathematically most convenient to express the elastic constants in this chapter by the shear modulus G and the dimensionless coefficient η , rather than another combination of elastic coefficients, such as E and ν or K and G .

6.2.2 Displacement functions

It can be derived, by differentiating equation (6.14) with respect to x , differentiating equation (6.15) with respect to z , and then adding the two resulting equations, that

$$\nabla^2(2\eta G\varepsilon - \alpha p) = 0. \quad (6.17)$$

This means that one may write

$$\frac{\alpha p}{2G} = \eta\varepsilon + \phi \frac{\partial F}{\partial z}, \quad (6.18)$$

where ϕ is a constant that will be specified later, and F is any harmonic function,

$$\nabla^2 F = 0. \quad (6.19)$$

Furthermore, it is assumed that the two equilibrium equations can be satisfied by writing

$$u_x = -\frac{\partial D}{\partial x} + z \frac{\partial F}{\partial x}, \quad (6.20)$$

$$u_z = -\frac{\partial D}{\partial z} + z \frac{\partial F}{\partial z} + (1 - 2\phi)F, \quad (6.21)$$

where ϕ is the same constant as introduced in equation (6.18).

It follows from equations (6.20) and (6.21) that the volume strain ε can be expressed as

$$\varepsilon = \frac{\partial u_x}{\partial x} + \frac{\partial u_z}{\partial z} = -\nabla^2 D + 2(1 - \phi) \frac{\partial F}{\partial z}. \quad (6.22)$$

With equation (6.18) it follows that the pore pressure can be expressed into the displacement functions D and F by the relation

$$\frac{\alpha p}{2G} = -\eta \nabla^2 D + \phi' \frac{\partial F}{\partial z}, \quad (6.23)$$

where

$$\phi' = \phi + 2\eta(1 - \phi). \quad (6.24)$$

It can easily be verified that the equilibrium equations (6.14) and (6.15) are identically satisfied, provided that the function F is indeed harmonic, as specified in equation (6.19). The constant ϕ remains undetermined at this stage.

The differential equation for the displacement function D can be obtained by substitution of equations (6.22) and (6.23) into the storage equation (6.1). In this process the coefficient ϕ is chosen such that the coefficient of the term $\partial^2 F / \partial t \partial z$ vanishes, so that the differential equation for D remains as simple as possible. This leads to the condition

$$\phi = \frac{\alpha^2 + S(K + \frac{4}{3}G)}{\alpha^2 + S(K + \frac{1}{3}G)}. \quad (6.25)$$

The final differential equation for the function D is

$$\frac{\partial}{\partial t} \nabla^2 D = c \nabla^2 \nabla^2 D, \quad (6.26)$$

where the consolidation coefficient c is defined as

$$c = \frac{k(K + \frac{4}{3}G)}{[\alpha^2 + S(K + \frac{4}{3}G)]\gamma_f}. \quad (6.27)$$

It may be noted that in the original publications by McNamee & Gibson (1960) the displacement functions were denoted by E and S , whereas they are denoted here by D and F . The reason for this is that it is preferred to use the symbols E and S for the modulus of elasticity and the storativity, respectively.

The expressions for the total stresses are found to be

$$\frac{\sigma_{xx}}{2G} = \varepsilon - \frac{\partial u_x}{\partial x} + \phi \frac{\partial F}{\partial z} = -\frac{\partial^2 D}{\partial z^2} - z \frac{\partial^2 F}{\partial x^2} + (2 - \phi) \frac{\partial F}{\partial z}, \quad (6.28)$$

$$\frac{\sigma_{zz}}{2G} = \varepsilon - \frac{\partial u_z}{\partial z} + \phi \frac{\partial F}{\partial z} = -\frac{\partial^2 D}{\partial x^2} - z \frac{\partial^2 F}{\partial z^2} + \phi \frac{\partial F}{\partial z}, \quad (6.29)$$

$$\frac{\sigma_{xz}}{2G} = -\frac{1}{2} \frac{\partial u_x}{\partial z} - \frac{1}{2} \frac{\partial u_z}{\partial x} = \frac{\partial^2 D}{\partial x \partial z} - z \frac{\partial^2 F}{\partial x \partial z} - (1 - \phi) \frac{\partial F}{\partial x}. \quad (6.30)$$

The isotropic total stress can be expressed as $\sigma_0 = -K\varepsilon + \alpha p$. With equations (6.22) and (6.23) this gives

$$\frac{\sigma_0}{2G} = \frac{2}{3}\varepsilon + \phi \frac{\partial F}{\partial z} = -\frac{2}{3}\nabla^2 D + \frac{1}{3}(4 - \phi) \frac{\partial F}{\partial z}. \quad (6.31)$$

The equations in this section are in agreement with those given by Verruijt (1971) and Detournay & Cheng (1993), except for some minor differences in sign conventions and notations. In the case of incompressible constituents $S = 0$ and $\phi = 1$, and all equations reduce to those of McNamee & Gibson (1960). It may be noted that for the generalized problems involving a compressible fluid and compressible solid particles, the equations for all stresses and displacements are only slightly more complicated than in the original problems for incompressible constituents, as presented by McNamee & Gibson (1960).

6.3 Strip load on half plane

In this section some problems of plane strain deformation of the half space $z \geq 0$ will be considered. The boundary conditions are supposed to be that the surface $z = 0$ is fully drained ($p = 0$), free of shear stress ($\sigma_{zx} = 0$), and loaded by a given distribution of normal stresses σ_{zz} , see Figure 6.1, in particular a uniform stress on a strip. It is assumed that these boundary conditions can be expressed by the Laplace transforms

$$z = 0 : \bar{p} = 0, \quad (6.32)$$

$$z = 0 : \bar{\sigma}_{zx} = 0, \quad (6.33)$$

$$z = 0 : \bar{\sigma}_{zz} = 2G g(x), \quad (6.34)$$

where $g(x)$ is a given function, assumed to be even: $g(-x) = g(x)$. In this case it can be assumed that the displacements satisfy the symmetry properties

$$u_x(-x, z) = -u_x(x, z), \quad u_z(-x, z) = u_z(x, z). \quad (6.35)$$

6.3.1 General solution

In the two-dimensional case of symmetrical plane strain deformations of the half space $z > 0$ the general solution of the differential equations (6.19) and (6.26) can be written as the Laplace transforms

$$\bar{D} = \int_0^\infty \{A_1 \exp(-z\xi) + A_2 \exp(-z\sqrt{\xi^2 + \lambda^2})\} \cos(x\xi) d\xi, \quad (6.36)$$

$$\bar{F} = \int_0^\infty B_1 \exp(-z\xi) \cos(x\xi) d\xi, \quad (6.37)$$

where

$$\lambda^2 = s/c. \quad (6.38)$$

The solutions (6.36) and (6.37) have been obtained by omitting the terms that are unbounded at infinity, and by omitting the terms including a factor $\sin(x\xi)$, which would lead to asymmetric displacements.

From the two solutions the following derivatives can be derived

$$\frac{\partial \bar{D}}{\partial x} = - \int_0^\infty \{A_1 \xi \exp(-z\xi) + A_2 \xi \exp(-z\sqrt{\xi^2 + \lambda^2})\} \sin(x\xi) d\xi, \quad (6.39)$$

$$\frac{\partial^2 \bar{D}}{\partial x^2} = - \int_0^\infty \{A_1 \xi^2 \exp(-z\xi) + A_2 \xi^2 \exp(-z\sqrt{\xi^2 + \lambda^2})\} \cos(x\xi) d\xi, \quad (6.40)$$

$$\frac{\partial^2 \bar{D}}{\partial z^2} = \int_0^\infty \{A_1 \xi^2 \exp(-z\xi) + A_2 (\xi^2 + \lambda^2) \exp(-z\sqrt{\xi^2 + \lambda^2})\} \cos(x\xi) d\xi, \quad (6.41)$$

$$\nabla^2 \bar{D} = \int_0^\infty A_2 \lambda^2 \exp(-z\sqrt{\xi^2 + \lambda^2}) \cos(x\xi) d\xi, \quad (6.42)$$

$$\frac{\partial^2 \bar{D}}{\partial x \partial z} = \int_0^\infty \{A_1 \xi^2 \exp(-z\xi) + A_2 \xi \sqrt{\xi^2 + \lambda^2} \exp(-z\sqrt{\xi^2 + \lambda^2})\} \sin(x\xi) d\xi, \quad (6.43)$$

$$\frac{\partial \bar{F}}{\partial x} = - \int_0^\infty B_1 \xi \exp(-z\xi) \sin(x\xi) d\xi, \quad (6.44)$$

$$\frac{\partial^2 \bar{F}}{\partial x^2} = - \int_0^\infty B_1 \xi^2 \exp(-z\xi) \cos(x\xi) d\xi, \quad (6.45)$$

$$\frac{\partial^2 \bar{F}}{\partial x \partial z} = \int_0^\infty B_1 \xi^2 \exp(-z\xi) \sin(x\xi) d\xi, \quad (6.46)$$

$$\frac{\partial \bar{F}}{\partial z} = - \int_0^\infty B_1 \xi \exp(-z\xi) \cos(x\xi) d\xi, \quad (6.47)$$

$$\frac{\partial^2 \bar{F}}{\partial z^2} = \int_0^\infty B_1 \xi^2 \exp(-z\xi) \cos(x\xi) d\xi. \quad (6.48)$$

The boundary conditions will next be used to determine the three constants A_1 , A_2 and B_1 .

It follows from equation (6.23) that

$$\frac{\alpha \bar{p}}{2G} = - \int_0^\infty \{A_2 \eta \lambda^2 \exp(-z\sqrt{\xi^2 + \lambda^2}) + B_1 \phi' \xi \exp(-z\xi)\} \cos(x\xi) d\xi. \quad (6.49)$$

The first boundary condition, equation (6.32), now gives

$$A_2 \eta \lambda^2 + B_1 \phi' \xi = 0. \quad (6.50)$$

Furthermore, it follows from equation (6.30) that

$$\begin{aligned} \frac{\bar{\sigma}_{zx}}{2G} = \int_0^\infty \{A_1 \xi^2 \exp(-z\xi) + A_2 \xi \sqrt{\xi^2 + \lambda^2} \exp(-z\sqrt{\xi^2 + \lambda^2}) + \\ B_1 (1 - \phi - z\xi) \xi \exp(-z\xi)\} \sin(x\xi) d\xi. \end{aligned} \quad (6.51)$$

The second boundary condition, equation (6.33), now gives

$$A_1 \xi^2 + A_2 \xi \sqrt{\xi^2 + \lambda^2} + B_1 (1 - \phi) \xi = 0. \quad (6.52)$$

Finally, it follows from equation (6.29) that

$$\frac{\bar{\sigma}_{zz}}{2G} = \int_0^\infty \{A_1 \xi^2 \exp(-z\xi) + A_2 \xi^2 \exp(-z\sqrt{\xi^2 + \lambda^2}) - B_1 (\phi + z\xi) \xi \exp(-z\xi)\} \cos(x\xi) d\xi. \quad (6.53)$$

The third boundary condition, equation (6.34), now gives

$$\int_0^\infty \{A_1 \xi^2 + A_2 \xi^2 - B_1 \phi \xi\} \cos(x\xi) d\xi = g(x). \quad (6.54)$$

From the three boundary conditions the three constants A_1 , A_2 and B_1 can be determined.

It follows from equation (6.50) that

$$B_1 \xi = -A_2 \eta \lambda^2 / \phi'. \quad (6.55)$$

And then it follows from equation (6.52) that

$$A_1 \xi^2 = -A_2 (\xi \sqrt{\xi^2 + \lambda^2} - \eta \lambda^2 (1 - \phi) / \phi'). \quad (6.56)$$

Using equations (6.55) and (6.56) it follows that equation (6.54) can be written as

$$\int_0^{\infty} A_2 \{ \xi^2 + \eta\lambda^2/\phi' - \xi\sqrt{\xi^2 + \lambda^2} \} \cos(x\xi) d\xi = g(x). \quad (6.57)$$

The integral equation (6.57) is in the form of a Fourier cosine transform. Its inverse is

$$A_2 = \frac{2}{\pi} \frac{1}{\xi^2 + \eta\lambda^2/\phi' - \xi\sqrt{\xi^2 + \lambda^2}} \int_0^{\infty} g(x) \cos(\xi x) dx. \quad (6.58)$$

The two other constants, A_1 and B_1 , can now be determined from the equations (6.56) and (6.55),

$$A_1 = -\frac{2}{\pi} \frac{\xi\sqrt{\xi^2 + \lambda^2} - \eta\lambda^2(1 - \phi)/\phi'}{\xi^2(\xi^2 + \eta\lambda^2/\phi' - \xi\sqrt{\xi^2 + \lambda^2})} \int_0^{\infty} g(x) \cos(\xi x) dx, \quad (6.59)$$

$$B_1 = -\frac{2}{\pi} \frac{\eta\lambda^2/\phi'}{\xi(\xi^2 + \eta\lambda^2/\phi' - \xi\sqrt{\xi^2 + \lambda^2})} \int_0^{\infty} g(x) \cos(\xi x) dx. \quad (6.60)$$

The general solution of the problem has now been obtained, in the form of Laplace transforms.

For future reference it is convenient to also give here the expressions for the Laplace transforms of the horizontal total stress and the isotropic total stress.

From equation (6.28) it follows that

$$\frac{\bar{\sigma}_{xx}}{2G} = -\nabla^2 \bar{D} + \frac{\partial^2 \bar{D}}{\partial x^2} - z \frac{\partial^2 \bar{F}}{\partial x^2} + (2 - \phi) \frac{\partial \bar{F}}{\partial z}. \quad (6.61)$$

This gives, using the expressions (6.36) – (6.48),

$$\frac{\bar{\sigma}_{xx}}{2G} = -\int_0^{\infty} \{ [A_1 \xi^2 + B_1 \xi(2 - \phi - z\xi)] \exp(-z\xi) + A_2(\xi^2 + \lambda^2) \exp(-z\sqrt{\xi^2 + \lambda^2}) \} \cos(x\xi) d\xi. \quad (6.62)$$

Equation (6.31) expresses that

$$\frac{\bar{\sigma}_0}{2G} = -\frac{2}{3} \nabla^2 \bar{D} + \frac{1}{3} (4 - \phi) \frac{\partial \bar{F}}{\partial z}. \quad (6.63)$$

This gives, using the expressions (6.36) – (6.48),

$$\frac{\bar{\sigma}_0}{2G} = -\frac{1}{3} \int_0^{\infty} \{ 2A_2 \lambda^2 \exp(-z\sqrt{\xi^2 + \lambda^2}) + (4 - \phi) B_1 \xi \exp(-z\xi) \} \cos(x\xi) d\xi. \quad (6.64)$$

6.3.2 Results for a strip load

In the case of a uniform load q over a strip of width $2a$, applied at time $t = 0$ and remaining constant for $t > 0$, the boundary condition for the vertical normal stress is

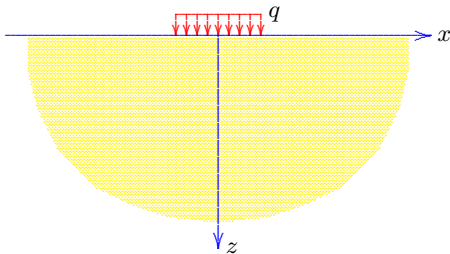

$$z = 0 : \frac{\sigma_{zz}}{2G} = \begin{cases} q/2G, & |x| < a, \\ 0, & |x| > a. \end{cases} \quad (6.65)$$

The Laplace transform of this condition is

$$z = 0 : \frac{\bar{\sigma}_{zz}}{2G} = g(x) = \begin{cases} q/2Gs, & |x| < a, \\ 0, & |x| > a. \end{cases} \quad (6.66)$$

Figure 6.2: Strip load on half space.

The representation of this function by a Fourier integral is

$$g(x) = \frac{q}{\pi Gs} \int_0^{\infty} \frac{\sin(a\xi)}{\xi} \cos(x\xi) d\xi. \quad (6.67)$$

The inverse of this equation is

$$\int_0^{\infty} g(x) \cos(\xi x) dx = \frac{q}{2Gs\xi} \sin(\xi a). \quad (6.68)$$

Substitution of this result into equations (6.58) – (6.60) gives

$$A_2 = \frac{q}{\pi G s} \frac{1}{\xi(\xi^2 + \eta\lambda^2/\phi' - \xi\sqrt{\xi^2 + \lambda^2})} \sin(\xi a), \quad (6.69)$$

$$A_1 = -\frac{q}{\pi G s} \frac{\xi\sqrt{\xi^2 + \lambda^2} - \eta\lambda^2(1 - \phi)/\phi'}{\xi^3(\xi^2 + \eta\lambda^2/\phi' - \xi\sqrt{\xi^2 + \lambda^2})} \sin(\xi a), \quad (6.70)$$

$$B_1 = -\frac{q}{\pi G s} \frac{\eta\lambda^2/\phi'}{\xi^2(\xi^2 + \eta\lambda^2/\phi' - \xi\sqrt{\xi^2 + \lambda^2})} \sin(\xi a). \quad (6.71)$$

Expressions for the displacements, the pore pressures and all stress components can now be elaborated. This will require inverse Fourier and Laplace transforms. In some cases this may be possible using analytical methods, but in most cases this may require a numerical method.

In the next sections the pore pressure and the stresses will be considered, and examples will be given for the distribution of these quantities throughout the half plane. The displacements are not considered, as it can be expected that the inverse transforms will not converge, as is generally true for a half plane with a non-zero resultant load (Timoshenko & Goodier, 1970).

Pore pressure

The general expression for the Laplace transform of the pore pressure has been given in equation (6.49),

$$\frac{\alpha \bar{p}}{2G} = -\int_0^{\infty} \{A_2 \eta \lambda^2 \exp(-z\sqrt{\xi^2 + \lambda^2}) + B_1 \phi' \xi \exp(-z\xi)\} \cos(x\xi) d\xi. \quad (6.72)$$

Inserting the expressions (6.69) and (6.71) for the constants A_2 and B_1 gives

$$\frac{\bar{p}}{q} = \int_0^{\infty} g(s) \sin(a\xi) \cos(x\xi) d\xi, \quad (6.73)$$

where

$$g(s) = \int_0^{\infty} G(t) \exp(-st) dt = \frac{2\eta}{\pi c \alpha \xi} \frac{\exp(-z\xi) - \exp(-z\sqrt{\xi^2 + s/c})}{\xi^2 + bs/c - \xi\sqrt{\xi^2 + s/c}}, \quad (6.74)$$

with $b = \eta/\phi'$, and $\lambda^2 = s/c$, in agreement with the definition (6.38).

Equation (6.74) can be brought in the form of two Laplace transforms given in Appendix A, by writing it as

$$g(s) = \frac{2\eta}{\pi \alpha \xi (2b - 1)} \{\exp(-z\xi) f_2(\xi\sqrt{c}, s) - f_1(\xi\sqrt{c}, z/\sqrt{c}, s)\}, \quad (6.75)$$

where

$$f_1(u, k, s) = (2b - 1) \frac{\exp(-k\sqrt{s + u^2})}{u^2 + bs - u\sqrt{s + u^2}}, \quad (6.76)$$

$$f_2(u, s) = (2b - 1) \frac{1}{u^2 + bs - u\sqrt{s + u^2}}. \quad (6.77)$$

It now follows, using equations (A.7) and (A.10) from Appendix A, that the inverse transform of equation (6.75) is

$$G(t) = \frac{2\eta}{\pi \alpha \xi (2b - 1)} \{\exp(-z\xi) F_2(\xi\sqrt{c}, t) - F_1(\xi\sqrt{c}, z/\sqrt{c}, t)\}, \quad (6.78)$$

where

$$F_1(u, k, t) = \exp(-ku)[1 + \operatorname{erf}(u\sqrt{t} - k/\sqrt{4t})] \\ + d \exp[-(1-d^2)u^2t + dku][1 - \operatorname{erf}(du\sqrt{t} + k/\sqrt{4t})], \quad (6.79)$$

$$F_2(u, t) = 1 + \operatorname{erf}(u\sqrt{t}) + d \exp[-(1-d^2)u^2t][1 - \operatorname{erf}(du\sqrt{t})], \quad (6.80)$$

with

$$d = 1 - 1/b, \quad b = 1/(1-d). \quad (6.81)$$

The pore pressure can now be determined from the inverse form of equation (6.73),

$$\frac{p}{q} = \int_0^\infty G(t) \sin(a\xi) \cos(x\xi) d\xi, \quad (6.82)$$

where $G(t)$ is given by equation (6.78).

This Fourier integral transform may be evaluated numerically. For this purpose it seems convenient to introduce dimensionless parameters as

$$u = a\xi, \quad \zeta = z/a, \quad \rho = x/a, \quad \tau = ct/a^2. \quad (6.83)$$

The integral (6.82) is then transformed into

$$\frac{p}{q} = \int_0^\infty G(\tau) \sin(u) \cos(\rho u) du, \quad (6.84)$$

where now $G(\tau)$ is given by

$$G(\tau) = \frac{2\eta}{\pi\alpha(2b-1)u} \{ \exp(-\zeta u) F_2(u, \tau) - F_1(u, \zeta, \tau) \}. \quad (6.85)$$

The physical parameters now are the dimensionless horizontal coordinate $\rho = x/a$, the dimensionless vertical coordinate $\zeta = z/a$, and the dimensionless time factor $\tau = ct/a^2$. The integration variable is u . Convergence of the integral can be expected because of the factor u in the denominator of the integrand. At the origin the integrand is finite, because there $\sin(u)/u \approx 1$.

A graphical representation of the pore pressure distribution can be produced using a computer program PSP for plane strain poroelasticity, written in C++. Contours of the pore pressure ratio p/q are shown in Figure 6.3 for $ct/a^2 = 0.0001$. The physical parameters were chosen as $\nu = 0$, $\alpha = 1$, $S = 0$. The interval between successive contours is $\Delta p = 0.05 q$. The maximum value of the pore pressure in this case is 0.9437.

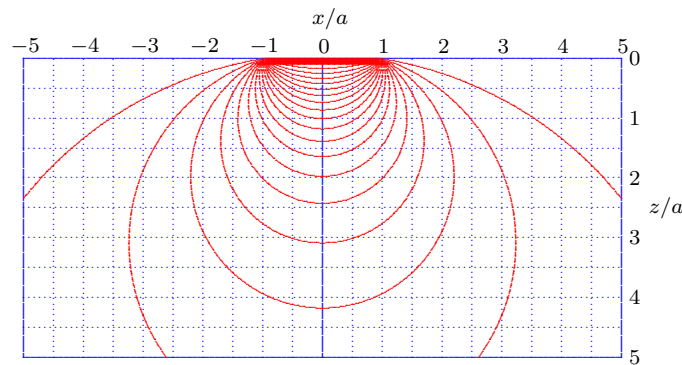
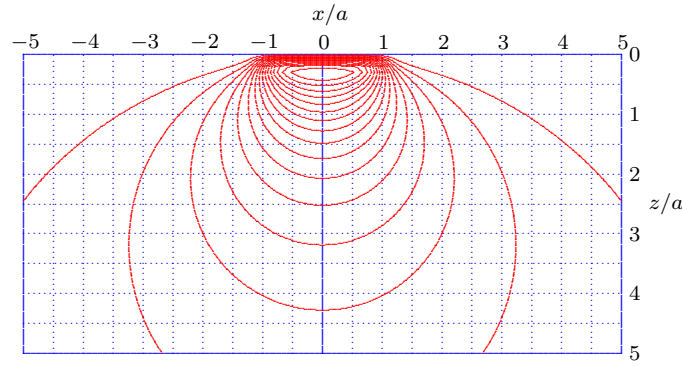
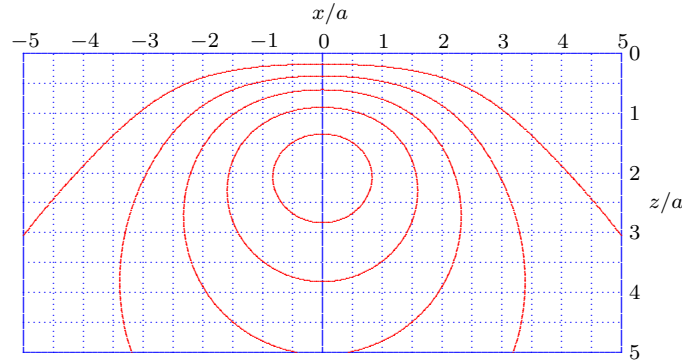

Figure 6.3: PSP : Pore pressure (Analytic), $ct/a^2 = 0.0001$.

It can be seen from the figure that the consolidation process for such a small value of time is concentrated near the loaded part of the surface, as could be expected.

Figures 6.4 and 6.5 show the contours for $ct/a^2 = 0.01$ and $ct/a^2 = 1$. Then the consolidation process is gradually more advanced, with the maximum pore pressure being reduced to 0.8456, respectively 0.2735. The contour interval in these figures is again $\Delta p = 0.05 q$.

Figure 6.4: PSP : Pore pressure (Analytic), $ct/a^2 = 0.01$.Figure 6.5: PSP : Pore pressure (Analytic), $ct/a^2 = 1$.

Isotropic total stress

The isotropic total stress is an important quantity in poroelasticity, because it governs the coupling between the deformations of the porous medium and the pore pressure. The general expression for the Laplace transform of the isotropic total stress has been given in equation (6.64),

$$\frac{\bar{\sigma}_0}{2G} = -\frac{1}{3} \int_0^\infty \{2A_2\lambda^2 \exp(-z\sqrt{\xi^2 + \lambda^2}) + (4 - \phi)B_1\xi \exp(-z\xi)\} \cos(x\xi) d\xi. \quad (6.86)$$

Inserting the expressions (6.69) and (6.71) for the constants A_2 and B_1 gives

$$\frac{\bar{\sigma}_0}{q} = \int_0^\infty m(s) \sin(a\xi) \cos(x\xi) d\xi, \quad (6.87)$$

where

$$m(s) = \int_0^\infty M(t) \exp(-st) dt = \frac{2}{3\pi c\xi} \frac{(4 - \phi)b \exp(-z\xi) - 2 \exp(-z\sqrt{\xi^2 + s/c})}{\xi^2 + bs/c - \xi\sqrt{\xi^2 + s/c}}, \quad (6.88)$$

where, as before, $b = \eta/\phi'$ and $\lambda^2 = s/c$.

Equation (6.88) can be brought in the form of two Laplace transforms given in Appendix A, by writing it as

$$m(s) = \frac{2}{3\pi\xi(2b - 1)} \{(4 - \phi)b \exp(-z\xi) f_2(\xi\sqrt{c}, s) - 2f_1(\xi\sqrt{c}, z/\sqrt{c}, s)\}, \quad (6.89)$$

where the functions f_1 and f_2 have been defined in equations (6.76) and (6.77).

In the same way as in the previous section, it now follows that the inverse transform of equation (6.89) is

$$M(t) = \frac{2}{3\pi\xi(2b - 1)} \{(4 - \phi)b \exp(-z\xi) F_2(\xi\sqrt{c}, t) - 2F_1(\xi\sqrt{c}, z/\sqrt{c}, t)\}, \quad (6.90)$$

where the functions F_1 and F_2 have been defined in equations (6.79) and (6.80).

The isotropic total stress can now be determined from the inverse form of equation (6.87),

$$\frac{\sigma_0}{q} = \int_0^\infty M(t) \sin(a\xi) \cos(x\xi) d\xi, \quad (6.91)$$

where $M(t)$ is given by equation (6.90). The dimensionless form of this equation is, using the dimensionless parameters defined in equation (6.83),

$$\frac{\sigma_0}{q} = \int_0^\infty M(\tau) \sin(u) \cos(\rho u) du, \quad (6.92)$$

where now $M(\tau)$ is given by

$$M(\tau) = \frac{2}{3\pi(2b-1)u} \{(4-\phi)b \exp(-\zeta u) F_2(u, \tau) - 2F_1(u, \zeta, \tau)\}. \quad (6.93)$$

This inverse Fourier transform can be evaluated numerically.

A graphical representation of the distribution of the isotropic total stress can be produced using the computer program PSP. Contours of the stress ratio σ/q are shown in Figure 6.6 for $ct/a^2 = 0.0001$. The physical parameters were chosen as $\nu = 0$, $\alpha = 1$, $S = 0$. The interval between successive contours is $\Delta(\sigma/q) = 0.05$. The maximum value of the isotropic total stress in this case is 0.9437. This value is equal

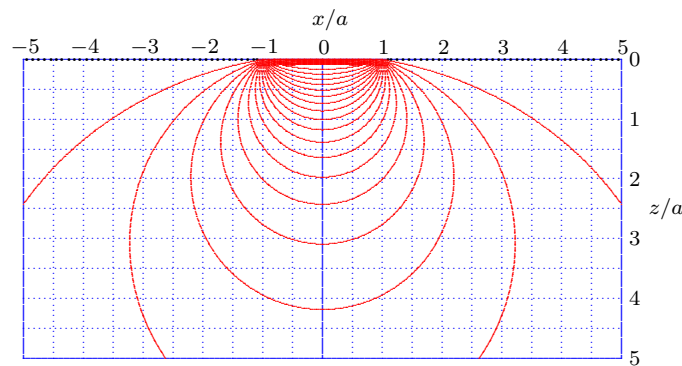

Figure 6.6: PSP : Isotropic total stress (Analytic), $ct/a^2 = 0.0001$.

to the pore pressure at that time, which indicates that the effective stresses are still extremely small.

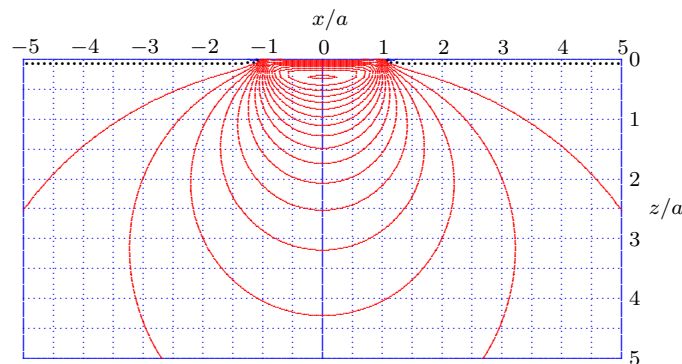

Figure 6.7: PSP : Isotropic total stress (Analytic), $ct/a^2 = 0.01$.

Figures 6.7 and 6.8 show the contours for $ct/a^2 = 0.01$ and $ct/a^2 = 1$. The maximum isotropic total stress then is 0.8573, respectively 0.5667. The dotted lines indicate that the variable σ/q is zero along these contours.

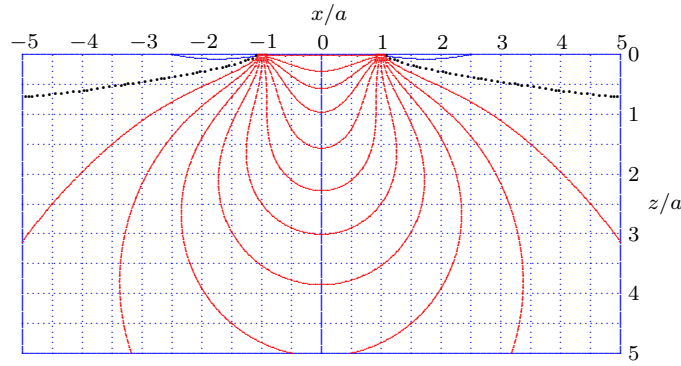

Figure 6.8: PSP : Isotropic total stress (Analytic), $ct/a^2 = 1$.

Isotropic effective stress

The isotropic effective stress can be expressed into the volume change ε by the equation

$$\sigma'_0 = -K\varepsilon. \quad (6.94)$$

Because $K/2G = \eta - \frac{2}{3}$ it then follows from equation (6.22) that

$$\frac{\bar{\sigma}'_0}{2G} = (\eta - \frac{2}{3}) \{ \nabla^2 \bar{D} - 2(1 - \phi) \frac{\partial \bar{F}}{\partial z} \}. \quad (6.95)$$

Using the expressions (6.42) and (6.47), and the expressions (6.69) and (6.71) for the constants A_2 and B_1 one obtains

$$\frac{\bar{\sigma}'_0}{q} = \int_0^\infty h(s) \sin(a\xi) \cos(x\xi) d\xi, \quad (6.96)$$

where

$$h(s) = \int_0^\infty H(t) \exp(-st) dt = \frac{2(\eta - \frac{2}{3})}{\pi c \xi} \frac{\exp(-z\sqrt{\xi^2 + s/c}) - 2b(1 - \phi) \exp(-z\xi)}{\xi^2 + bs/c - \xi\sqrt{\xi^2 + \lambda^2}}, \quad (6.97)$$

where, as before, $b = \eta/\phi'$ and $\lambda^2 = s/c$.

Equation (6.97) can be brought in the form of the two Laplace transforms given in Appendix A, by writing it as

$$h(s) = \frac{2(\eta - \frac{2}{3})}{\pi \xi (2b - 1)} \{ f_1(\xi\sqrt{c}, z/\sqrt{c}, s) - 2b(1 - \phi) \exp(-z\xi) f_2(\xi\sqrt{c}, s) \}, \quad (6.98)$$

where the functions f_1 and f_2 have been defined in equations (6.76) and (6.77).

In the same way as in the previous sections, it now follows that the inverse transform of equation (6.98) is

$$H(t) = \frac{2(\eta - \frac{2}{3})}{\pi \xi (2b - 1)} \{ F_1(\xi\sqrt{c}, z/\sqrt{c}, t) - 2b(1 - \phi) \exp(-z\xi) F_2(\xi\sqrt{c}, t) \}, \quad (6.99)$$

where the functions F_1 and F_2 have been defined in equations (6.79) and (6.80).

The isotropic effective stress can now be determined from the inverse form of equation (6.96),

$$\frac{\sigma'_0}{q} = \int_0^\infty H(t) \sin(a\xi) \cos(x\xi) d\xi, \quad (6.100)$$

where $H(t)$ is given by equation (6.99). This Fourier integral can be evaluated numerically. The dimensionless form of this equation is, using the dimensionless parameters defined in equation (6.83),

$$\frac{\sigma'_0}{q} = \int_0^\infty H(\tau) \sin(u) \cos(\rho u) du, \quad (6.101)$$

where now $H(\tau)$ is given by

$$H(\tau) = \frac{2(\eta - \frac{2}{3})}{\pi(2b - 1)u} \{F_1(u, \zeta, \tau) - 2b(1 - \phi) \exp(-\zeta u) F_2(u, \tau)\}. \quad (6.102)$$

Contours of the stress ratio σ'/q are shown in Figure 6.9 for $ct/a^2 = 0.0001$. The physical parameters were chosen as $\nu = 0$, $\alpha = 1$, $S = 0$. The interval between successive contours is $\Delta(\sigma'/q) = 0.05$. The maximum

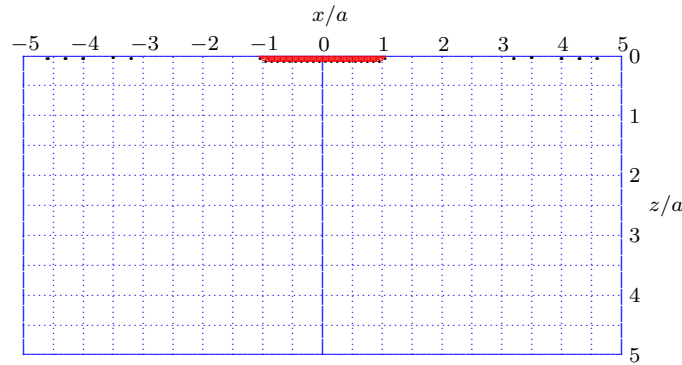

Figure 6.9: PSP : Isotropic effective stress (Analytic), $ct/a^2 = 0.0001$.

value of the isotropic effective stress in this case is 0.3436. As could be expected the effective stresses are concentrated near the loaded area for this small value of time.

Figures 6.10 and 6.11 show the contours for $ct/a^2 = 0.01$ and $ct/a^2 = 1$. The maximum isotropic effective stress then is 0.4454, respectively 0.5667. The dotted contours indicate that $\sigma'/q = 0$.

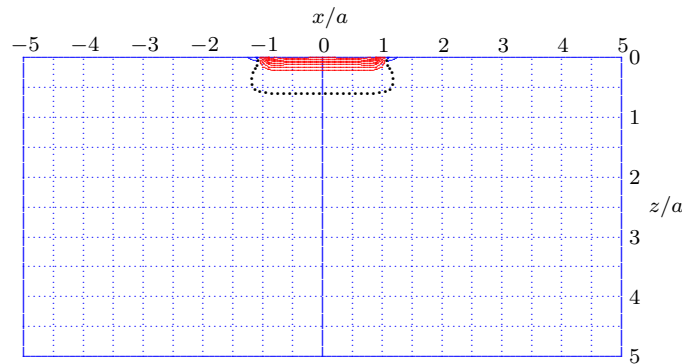

Figure 6.10: PSP : Isotropic effective stress (Analytic), $ct/a^2 = 0.01$.

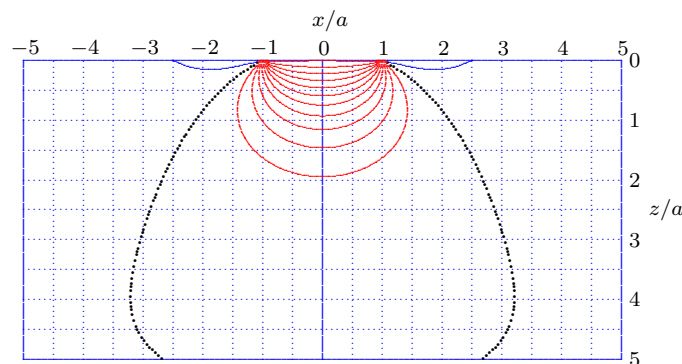

Figure 6.11: PSP : Isotropic effective stress (Analytic), $ct/a^2 = 1$.

6.3.3 Initial pore pressure

In problems such as the one considered here, with a load that is applied in a single step at time $t = 0$, it follows from the basics of the theory of poroelasticity, see section 1.9, that the behaviour of the porous material at the moment of loading can be considered to be a linear elastic response with the compression modulus K replaced by the undrained compression modulus K_u , defined as

$$K_u = K + \alpha^2/S, \quad (6.103)$$

where α is Biot's coefficient, $\alpha = 1 - C_s/C_m$, and S is the storativity, $S = nC_f + (\alpha - n)C_s$.

The initial value of the pore pressure is, see equation (1.59),

$$t = 0 : p_0 = -\frac{\alpha\varepsilon_0}{S} = \frac{\alpha\sigma_0}{K_u S} = \frac{\alpha\sigma_0}{\alpha^2 + K S}. \quad (6.104)$$

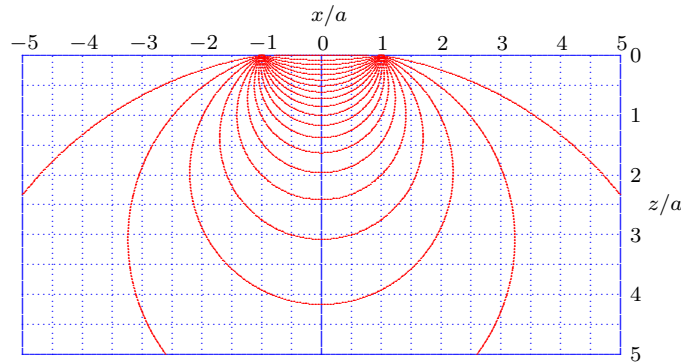

Figure 6.12: Elastic solution : Strip load, Isotropic stress.

In case of a porous material with incompressible particles, saturated with an incompressible fluid, $\alpha = 1$ and $S = 0$. It then follows from equation (6.103) that the undrained compression modulus $K_u \rightarrow \infty$, and it follows from the last form of equation (6.104) that the initial pore pressure equals the initial isotropic total stress. In such an undrained analysis an infinite value for the compression modulus can be simulated by taking $\nu \rightarrow \frac{1}{2}$.

For the present problem contours of the isotropic total stress in an elastic material with $\nu = \frac{1}{2}$ are shown in Figure 6.12. The maximum value of the stress, calculated by a computer program for plane strain elastic computations (PSE), is precisely $\sigma_0/q = 1.000000$, as it should be.

The results of a computation of the pore pressures in a poroelastic material, with $\alpha = 1$, $S = 0$, $\nu = 0$, and a very small value of time, have been shown already in Figure 6.3. The agreement is very good, except in the immediate vicinity of the loaded area, where drainage has already reduced the pore pressures to zero.

6.3.4 Numerical inversion of the Laplace transforms

Because for other stress components, to be considered later, analytic inversion of the Laplace transformation seems to be impossible, a numerical inversion method may be contemplated. In order to check the applicability of such a numerical inversion technique this will first be used for the contours of the pore pressure, which have already been evaluated in a previous section. The numerical inversion method to be used is Talbot's method (Talbot, 1979).

Pore pressure

The Talbot method will first be used for the numerical inversion of the function $g(s)$, appearing in the analysis of the pore pressure, see equation (6.74),

$$g(s) = \int_0^\infty G(t) \exp(-st) dt = \frac{2\eta}{\pi c \alpha \xi} \frac{\exp(-z\xi) - \exp(-z\sqrt{\xi^2 + s/c})}{\xi^2 + bs/c - \xi\sqrt{\xi^2 + s/c}}, \quad (6.105)$$

A convenient algorithm for the calculation of the inverse Laplace transform $G(t)$ is (Abata & Whitt, 2006)

$$G(t) = \frac{2}{5t} \sum_{k=0}^{M-1} \Re\{\gamma_k g(\delta_k/t)\}, \quad (6.106)$$

where M is an integer indicating the number of terms in the approximation (e.g. $M = 10$ or $M = 20$), and where

$$\delta_0 = \frac{2M}{5}, \quad \delta_k = \frac{2k\pi}{5} [\cot(k\pi/M) + i], \quad 0 < k < M, \quad (6.107)$$

$$\gamma_0 = \frac{\exp(\delta_0)}{2}, \quad \gamma_k = \left\{ 1 + i(k\pi/M)(1 + [\cot(k\pi/M)]^2) - i \cot(k\pi/M) \right\} \exp(\delta_k), \quad 0 < k < M. \quad (6.108)$$

It may be noted that for $k > 0$ the coefficients δ_k and γ_k are complex. It should also be noted that the coefficients depend only upon the value of M , and thus have to be calculated just once. It has been shown (Abate & Whitt, 2006) that the Talbot approximation usually is accurate to about $0.6 M$ significant digits, so that choosing $M = 10$ should give very accurate results.

According to equation (6.82) the pore pressure can be expressed as

$$\frac{p}{q} = \int_0^\infty G(t) \sin(a\xi) \cos(x\xi) d\xi. \quad (6.109)$$

Substitution of $G(t)$ from equation (6.106) into equation (6.109) gives

$$\frac{p}{q} = \frac{2}{5} \int_0^\infty \sum_{k=0}^{M-1} \Re\left\{ \gamma_k \frac{g(\delta_k/t)}{t} \right\} \sin(a\xi) \cos(x\xi) d\xi. \quad (6.110)$$

The expression $g(\delta_k/t)/t$ is, with equation (6.105), and using dimensionless variables $u = a\xi$, $\rho = x/a$, $\zeta = z/a$ and $\tau = ct/a^2$,

$$\frac{g(\delta_k/t)}{t} = \frac{2\eta a}{\pi\tau\alpha u} \frac{\exp(-\zeta u) - \exp(-\zeta\sqrt{u^2 + \delta_k/\tau})}{u^2 + b\delta_k/\tau - u\sqrt{u^2 + \delta_k/\tau}}. \quad (6.111)$$

Substitution of this result into equation (6.110) gives, again using the dimensionless variables introduced above,

$$\frac{p}{q} = \frac{4\eta}{5\pi\alpha} \int_0^\infty \sum_{k=0}^{M-1} \Re\left\{ \gamma_k \frac{\exp(-\zeta u) - \exp(-\zeta\sqrt{u^2 + \delta_k/\tau})}{\tau u^2 + b\delta_k - \tau u\sqrt{u^2 + \delta_k/\tau}} \right\} \frac{\sin(u)}{u} \cos(\rho u) du. \quad (6.112)$$

It should be noted that in the integrand the parameters γ_k and δ_k are complex. The numerical computation of the values of the integrand should not pose any problems, however. The Fourier integral transform (6.112) can be calculated numerically using Simpson's method.

For given values of x , z and t it is necessary to calculate M values of the function $G(t)$ numerically. This involves some complex algebra, but this should not pose serious difficulties for modern software. The integral over the variable ξ in equation (6.109) has been computed numerically, using Simpson's algorithm. The semi-infinite interval $0 < x < \infty$ may be restricted to the interval $0 < x < L$, where L can be determined iteratively, starting from an initial guess, say $L = 200/a$. This interval is subdivided for the numerical integration into N equal parts, where N is a suitably large number, say $N = 1000$. All computations have been carried out using the program PSP, written in C++. Although the program allows for arbitrary values ν , α and KS , the product of the compression modulus of the soil and its storativity, the examples have been calculated, as before, for a soil with incompressible particles and containing an incompressible pore fluid, so that Biot's coefficient $\alpha = 1$ and the storativity $S = 0$. The value of Poisson's ratio has been assumed to be $\nu = 0$.

The results of the program PSP for computations using analytical and numerical inversion of the Laplace transform are shown, for the case $ct/a^2 = 0.1$, in Figures 6.13 and 6.14. The number of terms in the Talbot method has been taken equal to 10. The maximum value of p/q is 0.6256, in both cases. The figures indicate that the results can not be distinguished from each other, which gives some support to the accuracy of Talbot's method. It may be observed that the analytical solution is calculated much faster than the numerical solution.

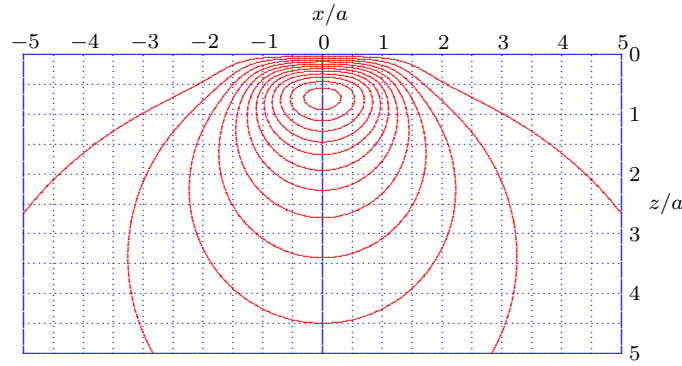
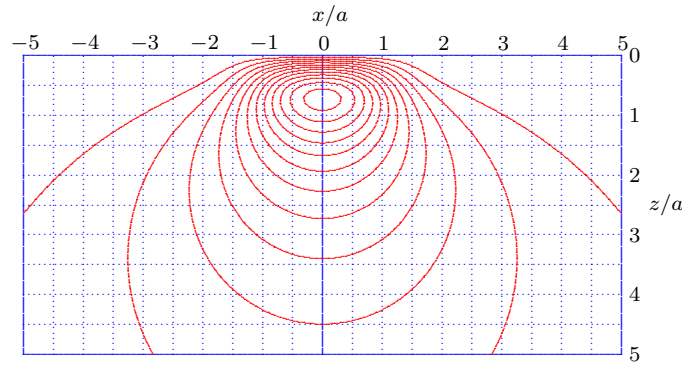
Figure 6.13: PSP : Pore pressure (Analytic), $ct/a^2 = 0.1$.Figure 6.14: PSP : Pore pressure (Numerical), $ct/a^2 = 0.1$.

Isotropic total stress

The Talbot method can also be used for the numerical inversion of the function $m(s)$, appearing in the analysis of the isotropic total stress, see equations (6.87) and (6.88),

$$\frac{\bar{\sigma}_0}{q} = \int_0^\infty m(s) \sin(a\xi) \cos(x\xi) d\xi, \quad (6.113)$$

where

$$m(s) = \int_0^\infty M(t) \exp(-st) dt = \frac{2}{3\pi c\xi} \frac{(4-\phi)b \exp(-z\xi) - 2 \exp(-z\sqrt{\xi^2 + s/c})}{\xi^2 + bs/c - \xi\sqrt{\xi^2 + s/c}}, \quad (6.114)$$

With Talbot's formula the inverse Laplace transform of equation (6.113) is

$$\frac{\sigma_0}{q} = \frac{2}{5} \int_0^\infty \sum_{k=0}^{M-1} \Re\{\gamma_k \frac{m(\delta_k/t)}{t}\} \sin(a\xi) \cos(x\xi) d\xi. \quad (6.115)$$

The expression $m(\delta_k/t)/t$ is, with equation (6.114), and using dimensionless variables $u = a\xi$, $\rho = x/a$, $\zeta = z/a$ and $\tau = ct/a^2$,

$$\frac{m(\delta_k/t)}{t} = \frac{2}{3\pi u} \frac{(4-\phi)b \exp(-\zeta u) - 2 \exp(-\zeta\sqrt{u^2 + \delta_k/\tau})}{\tau u^2 + b\delta_k - \tau u\sqrt{u^2 + \delta_k/\tau}}. \quad (6.116)$$

Substitution of this result into equation (6.115) gives, again using the dimensionless variables introduced above,

$$\frac{\sigma_0}{q} = \frac{4}{15\pi} \int_0^\infty \sum_{k=0}^{M-1} \Re\{\gamma_k \frac{(4-\phi)b \exp(-\zeta u) - 2 \exp(-\zeta\sqrt{u^2 + \delta_k/\tau})}{\tau u^2 + b\delta_k - \tau u\sqrt{u^2 + \delta_k/\tau}}\} \frac{\sin(u)}{u} \cos(\rho u) du. \quad (6.117)$$

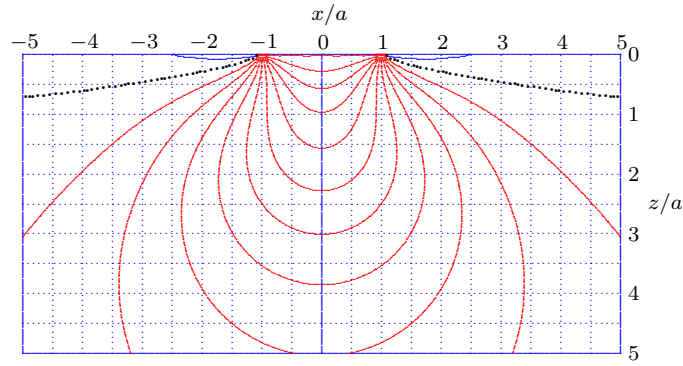
Figure 6.15: PSP : Isotropic total stress (Numerical), $ct/a^2 = 1$.

Numerical values of this expression can be calculated by the program PSP. An example is shown in Figure 6.15 for the case $ct/a^2 = 1$. The maximum value of the isotropic stress then is found to be 0.5667, which is in perfect agreement with the value obtained using the analytical inverse Laplace transform, see Figure 6.8.

Vertical total stress

The vertical total stress has been expressed in equation (6.53) in the form

$$\frac{\bar{\sigma}_{zz}}{2G} = \int_0^\infty \{A_1 \xi^2 \exp(-z\xi) + A_2 \xi^2 \exp(-z\sqrt{\xi^2 + \lambda^2}) - B_1 \xi(\phi + z\xi) \exp(-z\xi)\} \cos(x\xi) d\xi. \quad (6.118)$$

In view of the nature of the expressions for the constants A_1 , A_2 and B_1 , see equations (6.70), (6.69) and (6.71), the vertical total stress is written as

$$\frac{\sigma_{zz}}{q} = F(t) = \int_0^\infty S_{zz}(t) \sin(a\xi) \cos(x\xi) d\xi, \quad (6.119)$$

or, in the form of a Laplace transform,

$$\frac{\bar{\sigma}_{zz}}{q} = f(s) = \int_0^\infty s_{zz}(s) \sin(a\xi) \cos(x\xi) d\xi. \quad (6.120)$$

Using equations (6.118) and (6.119) the function $s_{zz}(s)$ is found to be, with $b = \eta/\phi'$ and $\lambda^2 = s/c$,

$$s_{zz}(s) = \frac{2}{\pi s \xi} \frac{\xi^2 \exp(-z\sqrt{\xi^2 + s/c}) + \{b(1 + z\xi)s/c - \xi\sqrt{\xi^2 + s/c}\} \exp(-z\xi)}{\xi^2 + bs/c - \xi\sqrt{\xi^2 + s/c}}. \quad (6.121)$$

The inverse Laplace transform might be obtained on the basis of the transforms given in Appendix-A, but this will require integration with respect to time, because of the additional factor s in the Laplace transform (6.121). It seems more effective to determine the inverse Laplace transform by Talbot's method,

$$S_{zz}(t) = \frac{2}{5t} \sum_{k=0}^{M-1} \Re\{\gamma_k s_{zz}(\delta_k/t)\}. \quad (6.122)$$

Substitution into equation (6.119) gives

$$\frac{\sigma_{zz}}{q} = \frac{2}{5} \int_0^\infty \sum_{k=0}^{M-1} \Re\{\gamma_k \frac{s_{zz}(\delta_k/t)}{t}\} \sin(a\xi) \cos(x\xi) d\xi. \quad (6.123)$$

Introducing dimensionless variables $u = a\xi$ and $\rho = x/a$ this can also be written as

$$\frac{\sigma_{zz}}{q} = \frac{2}{5a} \int_0^\infty \sum_{k=0}^{M-1} \Re\{\gamma_k \frac{s_{zz}(\delta_k/t)}{t}\} \sin(u) \cos(\rho u) du. \quad (6.124)$$

It follows from equation (6.121) that

$$\frac{s_{zz}(\delta_k/t)}{t} = \frac{2}{\pi\xi} \frac{\xi^2 \exp(-z\sqrt{\xi^2 + \delta_k/ct}) + \{b(1+z\xi)\delta_k/ct - \xi\sqrt{\xi^2 + \delta_k/ct}\} \exp(-z\xi)}{\delta_k \{\xi^2 + b\delta_k/ct - \xi\sqrt{\xi^2 + \delta_k/ct}\}}, \quad (6.125)$$

or, using dimensionless variables $u = a\xi$, $\zeta = z/a$, and $\tau = ct/a^2$,

$$\frac{s_{zz}(\delta_k/t)}{t} = \frac{2a}{\pi u} \frac{u^2 \exp(-\zeta\sqrt{u^2 + \delta_k/\tau}) + \{b(1+\zeta u)\delta_k/\tau - u\sqrt{u^2 + \delta_k/\tau}\} \exp(-\zeta u)}{\delta_k \{u^2 + b\delta_k/\tau - u\sqrt{u^2 + \delta_k/\tau}\}}, \quad (6.126)$$

Values of the parameter σ_{zz}/q can now be calculated using equations (6.124) and (6.126). It may be noted that the lower limit of the integration, for $u = 0$, is not a singularity, because for $u \rightarrow 0$ the integrand contains a factor $\sin(u)/u$, which tends towards 1. The calculations can be performed by the program PSP.

Contours for the case $\nu = 0$, $\alpha = 1$, $KS = 0$ are shown in Figures 6.16 and 6.17, for $ct/a^2 = 0.1$ and $ct/a^2 = 10000$, respectively.

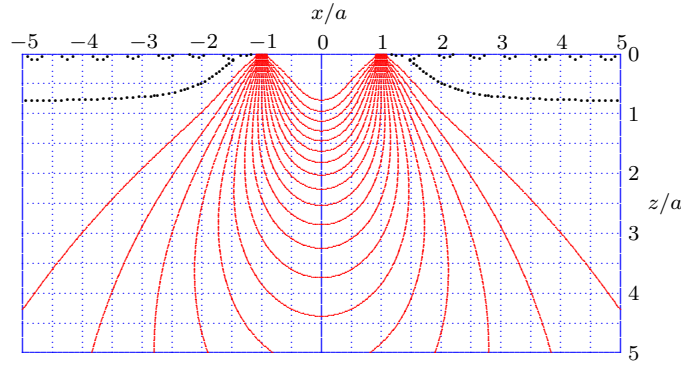

Figure 6.16: PSP : Vertical total stress, $ct/a^2 = 0.1$.

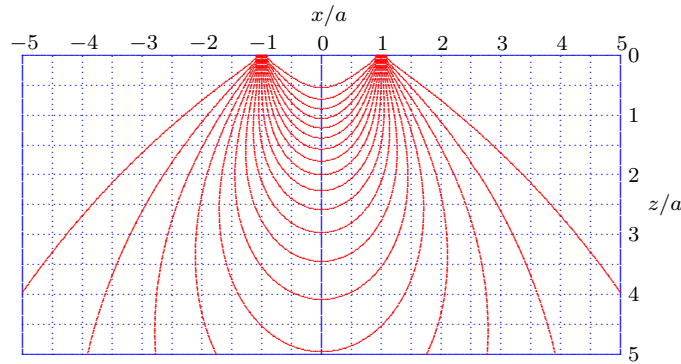

Figure 6.17: PSP : Vertical total stress, $ct/a^2 = 10000$.

The limiting values for $t \rightarrow \infty$ can be obtained using the Laplace transform property

$$\lim_{t \rightarrow \infty} F(t) = \lim_{s \rightarrow 0} s f(s). \quad (6.127)$$

Application of this theorem to the expressions (6.118) and (6.119) gives

$$\lim_{t \rightarrow \infty} \frac{\sigma_{zz}}{q} = \lim_{s \rightarrow 0} \frac{s \bar{\sigma}_{zz}}{q} = \frac{2}{\pi} \int_0^\infty \frac{(1 + \xi z) \sin(a\xi) \cos(x\xi) \exp(-z\xi)}{\xi} d\xi. \quad (6.128)$$

For $t \rightarrow \infty$ the consolidation process is practically completed, the pore pressures are zero, and the total stresses should be equal to those in the elastic case. The expression (6.128) is indeed in agreement with a result from the theory of elasticity, for a strip load on an elastic half space. These results are shown in graphical form

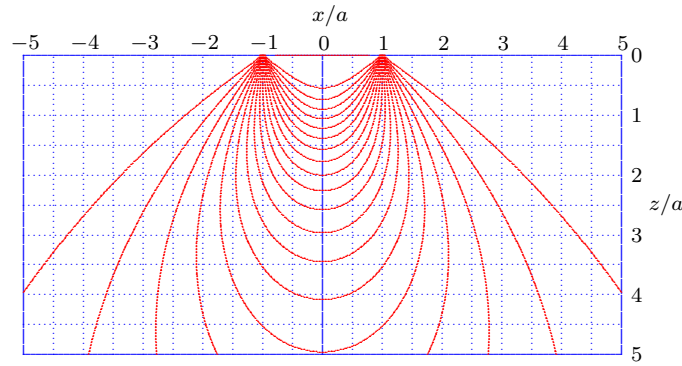

Figure 6.18: Elastic solution : Strip load, Vertical stress.

in Figure 6.18, as calculated by a program (PSE) for plane strain elastic stress computations. The stresses indeed appear to be the same as those in Figure 6.17. Actually, there appears to be little difference with the stresses at short values of time as well, as shown in Figure 6.16. The vertical total stresses appear not to change much during the consolidation process. This observation may be used to justify an approximate fully numerical approach to the solution of problems of poroelasticity, as first suggested by Rendulic (1936).

Vertical effective stress

Because $\sigma_{zz} = \sigma'_{zz} + \alpha p$, the vertical effective stress can easily be obtained from the expressions for the vertical total stress and the pore pressure. For the same values of the parameters the contours of the vertical effective stress are shown in Figure 6.19, for $ct/a^2 = 0.1$. For a very large value of time, say $ct/a^2 = 10000$, the pore

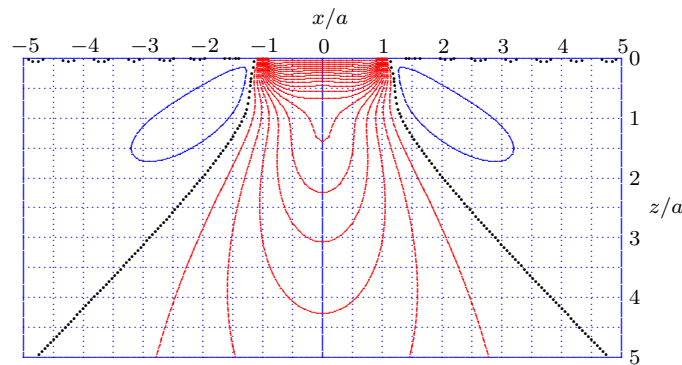

Figure 6.19: PSP : Vertical effective stress, $ct/a^2 = 0.1$.

pressures have been dissipated, and the vertical effective stress is practically equal to the vertical total stress, as shown in Figure 6.17.

Horizontal total stress

The horizontal total stress has been expressed in equation (6.62) in the form

$$\frac{\bar{\sigma}_{xx}}{2G} = - \int_0^\infty \{ [A_1 \xi^2 + B_1 \xi (2 - \phi - z\xi)] \exp(-z\xi) + A_2 (\xi^2 + \lambda^2) \exp(-z\sqrt{\xi^2 + \lambda^2}) \} \cos(x\xi) d\xi. \quad (6.129)$$

The constants A_1 , A_2 and B_1 have been given in equations (6.70), (6.69) and (6.71). In view of the character of the expressions for these constants the horizontal total stress is written as

$$\frac{\sigma_{xx}}{q} = \int_0^\infty S_{xx}(t) \sin(a\xi) \cos(x\xi) d\xi, \quad (6.130)$$

or, in the form of a Laplace transform,

$$\frac{\bar{\sigma}_{xx}}{q} = \int_0^\infty s_{xx}(t) \sin(a\xi) \cos(x\xi) d\xi, \quad (6.131)$$

where the function $s_{xx}(s)$ is the Laplace transform of the function $S_{xx}(t)$.

Using equations (6.129) and (6.131) the function $s_{xx}(s)$ is found to be, with $b = \eta/\phi'$ and $\lambda^2 = s/c$,

$$s_{xx}(s) = \frac{2}{\pi s \xi} \frac{\{b(1-z\xi)s/c + \xi\sqrt{\xi^2 + s/c}\} \exp(-z\xi) - (\xi^2 + s/c) \exp(-z\sqrt{\xi^2 + s/c})}{\xi^2 + bs/c - \xi\sqrt{\xi^2 + s/c}}. \quad (6.132)$$

The inverse Laplace transform will again be determined using Talbot's method,

$$S_{xx}(t) = \frac{2}{5t} \sum_{k=0}^{M-1} \Re\{\gamma_k s_{xx}(\delta_k/t)\}. \quad (6.133)$$

Substitution into equation (6.130) gives

$$\frac{\sigma_{xx}}{q} = \frac{2}{5t} \int_0^\infty \sum_{k=0}^{M-1} \Re\{\gamma_k s_{xx}(\delta_k/t)\} \sin(a\xi) \cos(x\xi) d\xi. \quad (6.134)$$

Introducing dimensionless variables $u = a\xi$ and $\rho = x/a$ this equation can be written as

$$\frac{\sigma_{xx}}{q} = \frac{2}{5} \int_0^\infty \sum_{k=0}^{M-1} \Re\{\gamma_k \frac{s_{xx}(\delta_k/t)}{at}\} \sin(u) \cos(\rho u) du. \quad (6.135)$$

From equation (6.132) it follows, using dimensionless variables $u = a\xi$, $\zeta = z/a$, and $\tau = ct/a^2$, that

$$\frac{s_{xx}(\delta_k/t)}{at} = \frac{2}{\pi u} \frac{\{b(1-\zeta u)\delta_k/\tau + u\sqrt{u^2 + \delta_k/\tau}\} \exp(-\zeta u) - (u^2 + \delta_k/t) \exp(-\zeta\sqrt{u^2 + \delta_k/\tau})}{\delta_k\{u^2 + b\delta_k/\tau - u\sqrt{u^2 + \delta_k/\tau}\}}. \quad (6.136)$$

Values of the parameter σ_{xx}/q can now be calculated using equations (6.135) and (6.136). The calculations can be performed by the program PSP.

Contours for the case $\nu = 0$, $\alpha = 1$, $S = 0$ are shown in Figures 6.20 and 6.21, for $ct/a^2 = 0.1$ and $ct/a^2 = 1000000$, respectively.

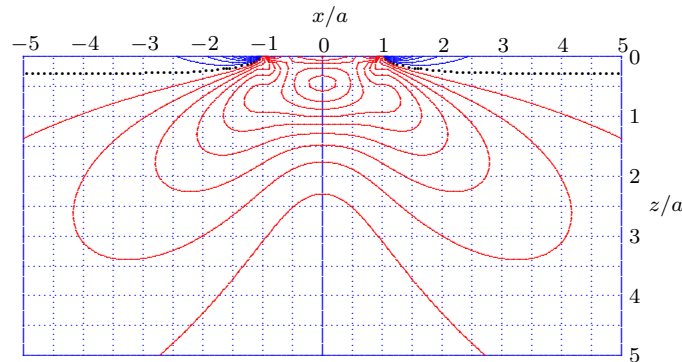

Figure 6.20: PSP : Horizontal total stress, $ct/a^2 = 0.1$.

The limiting values for $t \rightarrow \infty$ can be obtained using the Laplace transform property (Churchill, 1972)

$$\lim_{t \rightarrow \infty} F(t) = \lim_{s \rightarrow 0} s f(s). \quad (6.137)$$

Application of this theorem to the expressions (6.129) and (6.130) gives

$$\lim_{t \rightarrow \infty} \frac{\sigma_{xx}}{q} = \lim_{s \rightarrow 0} \frac{s \bar{\sigma}_{xx}}{q} = \frac{2}{\pi} \int_0^\infty \frac{(1-\xi z) \sin(a\xi) \cos(x\xi) \exp(-z\xi)}{\xi} d\xi. \quad (6.138)$$

For $t \rightarrow \infty$ the consolidation process is practically completed, the pore pressures are zero, and the total stresses should be equal to those in the elastic case. The expression (6.138) is indeed in agreement with a result from the theory of elasticity, for a strip load on an elastic half space. These results are shown in graphical form in Figure 6.22, as calculated by a program (PSE) for elastostatic stress computations. The agreement with the results shown in Figure 6.21 has been obtained only for a very large value of time. It appears that the consolidation process takes a very long time to obtain a steady state in the interior of the soil mass.

Figure 6.21: PSP : Horizontal total stress, $ct/a^2 = 1000000$.

Figure 6.22: Elastic solution : Strip load, Horizontal stress.

Horizontal effective stress

Because $\sigma_{xx} = \sigma'_{xx} + \alpha p$, the horizontal effective stress can easily be obtained from the expressions for the horizontal total stress and the pore pressure. For the same values of parameters the contours of the vertical effective stress are shown in Figure 6.23, for $ct/a^2 = 0.1$. For a very large value of time, $ct/a^2 = 1000000$, the

Figure 6.23: PSP : Horizontal effective stress, $ct/a^2 = 0.1$.

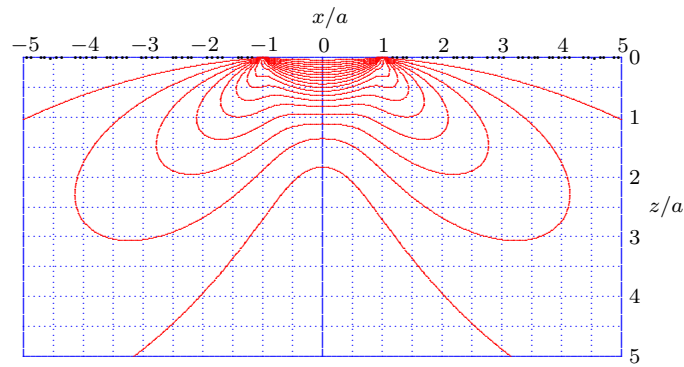
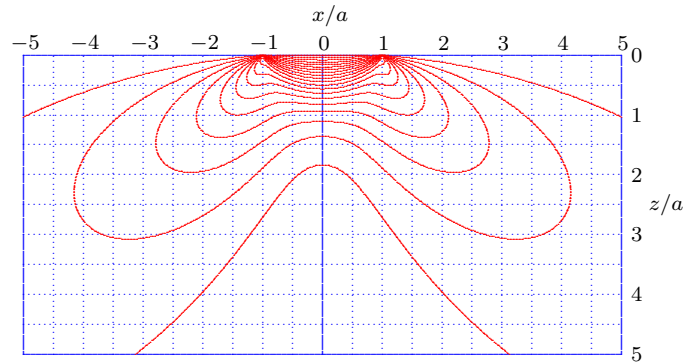
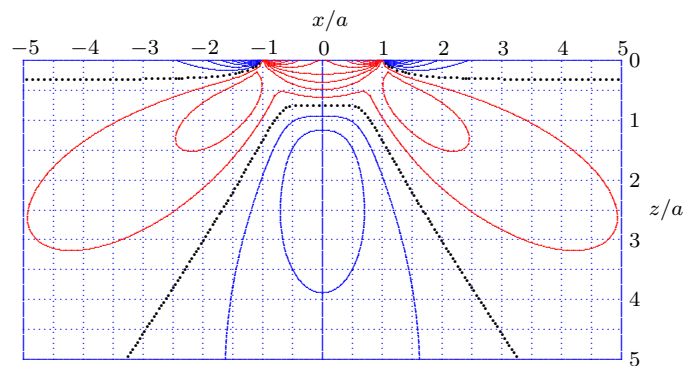
pore pressures have been dissipated, and the horizontal effective stress is practically equal to the horizontal total stress, as shown in Figure 6.21.

Chapter 7

PLANE STRAIN LAYER

7.1 Introduction

Following the presentation in the previous chapter of problems of plane strain deformations of a poroelastic half space, this chapter gives the solution for a layer of poroelastic material, supported by a smooth rigid bottom, and loaded on its upper surface by a strip load, see Figure 7.1. The problem was first considered by Gibson, Schiffman & Pu (1970), who gave the principles of the solution, and derived the analytic solution for the displacements of the free surface. In the present chapter the problem is generalized to the case including a compressible fluid and compressible particles, and the solution is elaborated for stresses and displacements throughout the layer, using the (approximate) numerical Laplace inversion method developed by Talbot (1979).

It may be mentioned that a variant of the problem, for a layer supported by a rough rigid bottom, was considered, using a fully numerical solution, by Christian, Boehmer & Martin (1972).

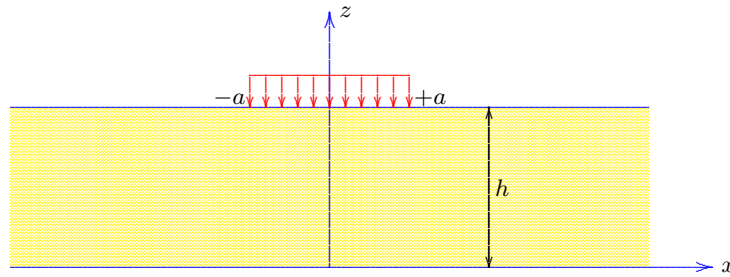

Figure 7.1: Strip load on poroelastic layer.

The thickness of the layer will be denoted by h , and the surface load is applied in the zone $-a < x < +a$, so that the total width of the loaded strip is $2a$.

7.2 Plane strain deformations

7.2.1 Basic equations

As in the case of problems of plane strain deformations in a poroelastic half plane, see section 6.2, the basic equations are the storage equation and the two equations of equilibrium in the two coordinate directions x and z . Again, the solution can most conveniently be derived using two displacement functions.

The two equilibrium equations can be expressed into these two displacement functions, see equations (6.20) and (6.21),

$$u_x = -\frac{\partial D}{\partial x} + z \frac{\partial F}{\partial x}, \quad (7.1)$$

$$u_z = -\frac{\partial D}{\partial z} + z \frac{\partial F}{\partial z} + (1 - 2\phi)F, \quad (7.2)$$

where ϕ is given by

$$\phi = \frac{\alpha^2 + S(K + \frac{4}{3}G)}{\alpha^2 + S(K + \frac{1}{3}G)}. \quad (7.3)$$

The volume strain ε can be expressed as

$$\varepsilon = -\nabla^2 D + 2(1 - \phi) \frac{\partial F}{\partial z}. \quad (7.4)$$

And the pore pressure can be expressed into the displacement functions D and F by the relation

$$\frac{\alpha p}{2G} = -\eta \nabla^2 D + \phi' \frac{\partial F}{\partial z}, \quad (7.5)$$

where

$$\phi' = \phi + 2\eta(1 - \phi), \quad \eta = \frac{1 - \nu}{1 - 2\nu} = \frac{K + \frac{4}{3}G}{2G}. \quad (7.6)$$

The differential equation for the displacement function F is

$$\nabla^2 F = 0, \quad (7.7)$$

The differential equation for the displacement function D is

$$\frac{\partial}{\partial t} \nabla^2 D = c \nabla^2 \nabla^2 D, \quad (7.8)$$

where the consolidation coefficient c is defined as

$$c = \frac{k(K + \frac{4}{3}G)}{[\alpha^2 + S(K + \frac{4}{3}G)]\gamma_f}. \quad (7.9)$$

The expressions for the total stresses now are, as in chapter 6,

$$\frac{\sigma_{xx}}{2G} = \varepsilon - \frac{\partial u_x}{\partial x} + \phi \frac{\partial F}{\partial z} = -\frac{\partial^2 D}{\partial z^2} - z \frac{\partial^2 F}{\partial x^2} + (2 - \phi) \frac{\partial F}{\partial z}, \quad (7.10)$$

$$\frac{\sigma_{zz}}{2G} = \varepsilon - \frac{\partial u_z}{\partial z} + \phi \frac{\partial F}{\partial z} = -\frac{\partial^2 D}{\partial x^2} - z \frac{\partial^2 F}{\partial z^2} + \phi \frac{\partial F}{\partial z}, \quad (7.11)$$

$$\frac{\sigma_{xz}}{2G} = -\frac{1}{2} \frac{\partial u_x}{\partial z} - \frac{1}{2} \frac{\partial u_z}{\partial x} = \frac{\partial^2 D}{\partial x \partial z} - z \frac{\partial^2 F}{\partial x \partial z} - (1 - \phi) \frac{\partial F}{\partial x}. \quad (7.12)$$

The isotropic total stress, $\sigma_0 = \frac{1}{3}(\sigma_{xx} + \sigma_{yy} + \sigma_{zz})$, can be expressed most simply as $\sigma_0 = -K\varepsilon + \alpha p$. This gives

$$\frac{\sigma_0}{2G} = \frac{2}{3}\varepsilon + \phi \frac{\partial F}{\partial z} = -\frac{2}{3}\nabla^2 D + \frac{1}{3}(4 - \phi) \frac{\partial F}{\partial z}. \quad (7.13)$$

7.3 Strip load on layer

For the problem of a strip load on a layer on a smooth rigid bottom, the boundary conditions are, when expressed by Laplace transforms,

$$z = 0 : \bar{u}_z = 0, \quad (7.14)$$

$$z = 0 : \frac{\partial \bar{p}}{\partial z} = 0, \quad (7.15)$$

$$z = 0 : \bar{\sigma}_{zx} = 0, \quad (7.16)$$

$$z = h : \bar{p} = 0, \quad (7.17)$$

$$z = h : \bar{\sigma}_{zx} = 0, \quad (7.18)$$

$$z = h : \bar{\sigma}_{zz} = \frac{2q}{\pi s} \int_0^\infty \frac{\sin(a\xi)}{\xi} \cos(x\xi) d\xi, \quad (7.19)$$

where q is the intensity of the surface load on the strip $-a < x < +a$.

Because of the symmetry of the load it can be expected that the displacements satisfy the symmetry properties

$$u_x(-x, z) = -u_x(x, z), \quad u_z(-x, z) = u_z(x, z). \quad (7.20)$$

7.3.1 General solution

In the two-dimensional case of symmetrical plane strain deformations the general solution of the differential equations (7.7) and (7.8) can be written in the form of Laplace transforms as

$$\begin{aligned} \bar{D} = \int_0^\infty \{A_1 \exp(z\xi) + A_2 \exp(z\sqrt{\xi^2 + \lambda^2})\} \cos(x\xi) d\xi \\ + \int_0^\infty \{A_3 \exp(-z\xi) + A_4 \exp(-z\sqrt{\xi^2 + \lambda^2})\} \cos(x\xi) d\xi, \end{aligned} \quad (7.21)$$

$$\bar{F} = \int_0^\infty B_1 \exp(z\xi) \cos(x\xi) d\xi + \int_0^\infty B_2 \exp(-z\xi) \cos(x\xi) d\xi. \quad (7.22)$$

where

$$\lambda^2 = s/c. \quad (7.23)$$

7.3.2 Conditions at the lower boundary

Because the boundary conditions at the lower boundary $z = 0$ are homogeneous, and for $z = 0$ all the functions become very simple, it seems advantageous to first consider these conditions.

Boundary condition (7.14) gives

$$(A_3 - A_1)\xi + (A_4 - A_2)\sqrt{\xi^2 + \lambda^2} + (1 - 2\phi)(B_1 + B_2) = 0. \quad (7.24)$$

Boundary condition (7.15) gives

$$\eta(A_4 - A_2)\lambda^2\sqrt{\xi^2 + \lambda^2} + \phi'(B_1 + B_2)\xi^2 = 0. \quad (7.25)$$

Boundary condition (7.16) gives

$$(A_3 - A_1)\xi^2 + (A_4 - A_2)\xi\sqrt{\xi^2 + \lambda^2} + (1 - \phi)(B_1 + B_2)\xi = 0. \quad (7.26)$$

It follows from these conditions that

$$B_1 + B_2 = 0, \quad B_2 = -B_1, \quad (7.27)$$

$$A_3 - A_1 = 0, \quad A_3 = A_1, \quad (7.28)$$

$$A_4 - A_2 = 0, \quad A_4 = A_2. \quad (7.29)$$

The general solution (7.21) can now be reduced to

$$\bar{D} = \int_0^\infty \{C_1 \cosh(z\xi) + C_2 \cosh(z\zeta)\} \cos(x\xi) d\xi, \quad (7.30)$$

where

$$\zeta = \sqrt{\xi^2 + \lambda^2} = \sqrt{\xi^2 + s/c}. \quad (7.31)$$

The general solution (7.22) can be reduced to

$$\bar{F} = \int_0^\infty C_3 \sinh(z\xi) \cos(x\xi) d\xi. \quad (7.32)$$

From these expressions the following derivatives can be determined.

$$\frac{\partial \bar{D}}{\partial x} = - \int_0^\infty \{C_1 \cosh(z\xi) + C_2 \cosh(z\zeta)\} \xi \sin(x\xi) d\xi, \quad (7.33)$$

$$\frac{\partial \bar{D}}{\partial z} = \int_0^\infty \{C_1 \xi \sinh(z\xi) + C_2 \zeta \sinh(z\zeta)\} \cos(x\xi) d\xi, \quad (7.34)$$

$$\frac{\partial^2 \bar{D}}{\partial x^2} = - \int_0^\infty \{C_1 \cosh(z\xi) + C_2 \cosh(z\zeta)\} \xi^2 \cos(x\xi) d\xi, \quad (7.35)$$

$$\frac{\partial^2 \bar{D}}{\partial z^2} = \int_0^\infty \{C_1 \xi^2 \cosh(z\xi) + C_2 \zeta^2 \cosh(z\zeta)\} \cos(x\xi) d\xi, \quad (7.36)$$

$$\nabla^2 \bar{D} = \int_0^\infty C_2 \lambda^2 \cosh(z\zeta) \cos(x\xi) d\xi, \quad (7.37)$$

$$\frac{\partial \nabla^2 \bar{D}}{\partial z} = \int_0^\infty C_2 \lambda^2 \zeta \sinh(z\zeta) \cos(x\xi) d\xi, \quad (7.38)$$

$$\frac{\partial^2 \bar{D}}{\partial x \partial z} = - \int_0^\infty \{C_1 \xi^2 \sinh(z\xi) + C_2 \xi \zeta \sinh(z\zeta)\} \sin(x\xi) d\xi, \quad (7.39)$$

$$\frac{\partial \bar{F}}{\partial x} = - \int_0^\infty C_3 \xi \sinh(z\xi) \sin(x\xi) d\xi. \quad (7.40)$$

$$\frac{\partial^2 \bar{F}}{\partial x^2} = - \int_0^\infty C_3 \xi^2 \sinh(z\xi) \cos(x\xi) d\xi. \quad (7.41)$$

$$\frac{\partial^2 \bar{F}}{\partial z^2} = \int_0^\infty C_3 \xi^2 \sinh(z\xi) \cos(x\xi) d\xi. \quad (7.42)$$

$$\frac{\partial \bar{F}}{\partial z} = \int_0^\infty C_3 \xi \cosh(z\xi) \cos(x\xi) d\xi. \quad (7.43)$$

$$\frac{\partial^2 \bar{F}}{\partial x \partial z} = - \int_0^\infty C_3 \xi^2 \cosh(z\xi) \sin(x\xi) d\xi. \quad (7.44)$$

Using these equations it can easily be verified that the boundary conditions (7.14), (7.15) and (7.16) are indeed satisfied.

7.3.3 Conditions at the upper boundary

Boundary condition (7.17) gives

$$-C_2 \eta (h\lambda)^2 \cosh(h\zeta) + C_3 h \phi'(h\xi) \cosh(h\xi) = 0,$$

or

$$C_3 h = C_2 \frac{\eta (h\lambda)^2 \cosh(h\zeta)}{\phi'(h\xi) \cosh(h\xi)}. \quad (7.45)$$

Boundary condition (7.18) gives

$$-C_1 (h\xi)^2 \sinh(h\xi) - C_2 (h\xi)(h\zeta) \sinh(h\zeta) + C_3 h (h\xi) \{(1 - \phi) \sinh(h\xi) + (h\xi) \cosh(h\xi)\} = 0,$$

or, with equation (7.45),

$$C_1 = C_2 \frac{R}{\phi'(h\xi) \sinh(h\xi) \cosh(h\xi)}, \quad (7.46)$$

where

$$R = \eta (h\lambda)^2 \cosh(h\zeta) \{(1 - \phi) \sinh(h\xi)/(h\xi) + \cosh(h\xi)\} - \phi'(h\zeta) \sinh(h\zeta) \cosh(h\xi). \quad (7.47)$$

Boundary condition (7.19) gives

$$C_1 \cosh(h\xi) + C_2 \cosh(h\zeta) - C_3 h \sinh(h\xi) + C_3 h \phi \cosh(h\xi)/(h\xi) = \frac{q}{\pi G s \xi^3} \sin(a\xi). \quad (7.48)$$

The four terms in this equation can be expressed into the constant C_2 by the following relations,

$$C_1 \cosh(h\xi) = C_2 \frac{R \cosh(h\xi)}{\phi'(h\xi) \sinh(h\xi) \cosh(h\xi)}, \quad (7.49)$$

$$C_2 \cosh(h\zeta) = C_2 \frac{\phi'(h\xi) \sinh(h\xi) \cosh(h\xi) \cosh(h\zeta)}{\phi'(h\xi) \sinh(h\xi) \cosh(h\xi)}, \quad (7.50)$$

$$C_3 h \sinh(h\xi) = C_2 \frac{\eta(h\lambda)^2 \sinh^2(h\xi) \cosh(h\zeta)}{\phi'(h\xi) \sinh(h\xi) \cosh(h\xi)}, \quad (7.51)$$

$$C_3 h \phi \cosh(h\xi)/(h\xi) = C_2 \frac{\phi \eta(h\lambda)^2 \sinh(h\xi) \cosh(h\xi) \cosh(h\zeta)/(h\xi)}{\phi'(h\xi) \sinh(h\xi) \cosh(h\xi)}, \quad (7.52)$$

It follows that

$$C_2 = \frac{q}{\pi G s \xi^3} \frac{\phi'(h\xi) \sinh(h\xi) \cosh(h\xi)}{Q} \sin(a\xi), \quad (7.53)$$

where

$$Q = R \cosh(h\xi) + \phi'(h\xi) \sinh(h\xi) \cosh(h\xi) \cosh(h\zeta) + \eta(h\lambda)^2 \sinh(h\xi) \cosh(h\zeta) \{\phi \cosh(h\xi)/(h\xi) - \sinh(h\xi)\}, \quad (7.54)$$

or, with equation (7.47), and using the property that $\cosh^2(h\xi) - \sinh^2(h\xi) = 1$,

$$Q = \eta(h\lambda)^2 \cosh(h\zeta) \{1 + \sinh(h\xi) \cosh(h\xi)/(h\xi)\} + \phi' \cosh(h\xi) \{(h\xi) \sinh(h\xi) \cosh(h\zeta) - (h\zeta) \sinh(h\zeta) \cosh(h\xi)\}. \quad (7.55)$$

With equations (7.45) and (7.46) it now follows that

$$C_1 = \frac{q}{\pi G s \xi^3} \frac{R}{Q} \sin(a\xi), \quad (7.56)$$

$$C_3 h = \frac{q}{\pi G s \xi^3} \frac{\eta(h\lambda)^2 \sinh(h\xi) \cosh(h\zeta)}{Q} \sin(a\xi). \quad (7.57)$$

This completes the solution in the form of Laplace and Fourier transforms.

7.3.4 The pore pressure

It follows from equation (7.5) that

$$\bar{p} = -\frac{2G\eta}{\alpha} \nabla^2 \bar{D} + \frac{2G\phi'}{\alpha} \frac{\partial \bar{F}}{\partial z}. \quad (7.58)$$

With equations (7.37) and (7.43) this gives

$$\bar{p} = -\frac{2G\eta}{\alpha} \int_0^\infty C_2 \lambda^2 \cosh(z\zeta) \cos(x\xi) d\xi + \frac{2G\phi'}{\alpha} \int_0^\infty C_3 \xi \cosh(z\xi) \cos(x\xi) d\xi. \quad (7.59)$$

Substituting the expressions (7.53) and (7.57) for the two constants C_2 and C_3 gives, with $\lambda^2 = s/c$,

$$\begin{aligned} \frac{\bar{p}}{q} = & \frac{2\eta\phi'h^2}{\pi c\alpha} \int_0^\infty \frac{\sinh(h\xi) \cosh(h\zeta)}{Q\xi(h\xi)} \cosh(z\xi) \cos(x\xi) \sin(a\xi) d\xi \\ & - \frac{2\eta\phi'h^2}{\pi c\alpha} \int_0^\infty \frac{\sinh(h\xi) \cosh(h\xi)}{Q\xi(h\xi)} \cosh(z\zeta) \cos(x\xi) \sin(a\xi) d\xi. \end{aligned} \quad (7.60)$$

This equation can also be written as

$$\frac{\bar{p}}{q} = \int_0^\infty g(s) \cos(x\xi) \sin(a\xi) d\xi, \quad (7.61)$$

where

$$g(s) = \frac{2\eta\phi'h^2}{\pi c\alpha} \frac{\cosh(h\zeta) \cosh(z\xi) - \cosh(h\xi) \cosh(z\zeta)}{Q\xi(h\xi)} \sinh(h\xi). \quad (7.62)$$

The function $g(s)$ is the Laplace transform of a function $G(t)$,

$$g(s) = \int_0^{\infty} G(t) \exp(-st) dt. \quad (7.63)$$

The inverse Laplace transform of equation (7.61) is

$$\frac{p}{q} = \int_0^{\infty} G(t) \cos(x\xi) \sin(a\xi) d\xi. \quad (7.64)$$

The mathematical problem now remaining is to determine the function $G(t)$ as the inverse Laplace transform of the function $g(s)$. It should be noted that the function $g(s)$ depends upon the parameter Q , which itself also depends upon the Laplace parameter s . The inverse Laplace transform will be determined using the numerical method of Talbot, which leads to an approximate result. When this has been determined the integral in equation (7.64) can be evaluated using Simpson's numerical integration method.

The algorithm to be used for the calculation of the inverse Laplace transform $G(t)$ is (Abata & Whitt, 2006)

$$G(t) = \frac{2}{5} \sum_{k=0}^{M-1} \Re\left\{\gamma_k \frac{g(\delta_k/t)}{t}\right\}, \quad (7.65)$$

where M is an integer indicating the number of terms in the approximation (e.g. $M = 10$ or $M = 20$), and where

$$\delta_0 = \frac{2M}{5}, \quad \delta_k = \frac{2k\pi}{5} [\cot(k\pi/M) + i], \quad 0 < k < M, \quad (7.66)$$

$$\gamma_0 = \frac{\exp(\delta_0)}{2}, \quad \gamma_k = \left\{1 + i(k\pi/M)(1 + [\cot(k\pi/M)]^2) - i \cot(k\pi/M)\right\} \exp(\delta_k), \quad 0 < k < M. \quad (7.67)$$

In the problem considered here

$$\frac{g(\delta_k/t)}{t} = \frac{2\eta\phi'h^2}{\pi c t \alpha} \frac{\cosh(h\sqrt{\xi^2 + \delta_k/ct}) \cosh(z\xi) - \cosh(h\xi) \cosh(z\sqrt{\xi^2 + \delta_k/ct})}{Q\xi(h\xi)} \sinh(h\xi). \quad (7.68)$$

For the numerical calculations it is convenient to introduce dimensionless variables $u = h\xi$, $x' = x/h$, $z' = z/h$, $a' = a/h$ and $\tau = ct/h^2$. Equation (7.68) then becomes

$$\frac{g(\delta_k/t)}{ht} = \frac{2\eta\phi'}{\pi\alpha\tau} \frac{\cosh(\sqrt{u^2 + \delta_k/\tau}) \cosh(z'u) - \cosh(u) \cosh(z'\sqrt{u^2 + \delta_k/\tau})}{Qu} \sinh(u), \quad (7.69)$$

and the integral (7.64) becomes

$$\frac{p}{q} = \frac{2}{5} \int_0^{\infty} \sum_{k=0}^{M-1} \Re\left\{\gamma_k \frac{g(\delta_k/t)}{ht}\right\} \cos(x'u) \frac{\sin(a'u)}{u} du, \quad (7.70)$$

where one of the factors u from the denominator of the expression (7.69) has been transferred to the integral (7.70).

The numerical procedures to calculate the values of the function given in equation (7.69) contain several factors $\cosh(u)$ and $\sinh(u)$, which will tend towards infinity if $u \rightarrow \infty$. The computations may therefore become inaccurate, which can perhaps be avoided by writing

$$\cosh(u) = e(1+d), \quad \sinh(u) = e(1-d), \quad (7.71)$$

where

$$e = \frac{1}{2} \exp(u), \quad d = \exp(-2d). \quad (7.72)$$

Equation (7.69) can now be written as

$$\frac{g(\delta_k/t)}{ht} = \frac{2\eta\phi'}{\pi\alpha\tau} \frac{\cosh(\sqrt{u^2 + \delta_k/\tau}) \cosh(z'u)/e - (1+d) \cosh(z'\sqrt{u^2 + \delta_k/\tau})}{Q'u} (1-d), \quad (7.73)$$

where $Q' = Qe^{-2}$, or

$$Q' = \eta(\delta_k/\tau) \cosh(\sqrt{u^2 + \delta_k/\tau}) \{e^{-2} + (1 - d^2)/u\} + \phi'(1 + d) \{u(1 - d) \cosh(\sqrt{u^2 + \delta_k/\tau}) - (\sqrt{u^2 + \delta_k/\tau}) \sinh(\sqrt{u^2 + \delta_k/\tau})(1 + d)\}. \quad (7.74)$$

The integral (7.70) can be calculated numerically by the program PSPL (Plane Strain Poroelastic Layer).

It may be noted that the parameters γ_k and δ_k are complex. In the numerical computation the parameters R and Q are also complex. It may also be noted that for small values of u : $\sin(a'u) \approx a'u$. This means that the integrand of equation (7.70) is finite for $u \rightarrow 0$.

Examples

For three values of the time parameter ct/h^2 the distribution of the pore pressures is shown in the figures 7.2, 7.3, and 7.4, shown below.

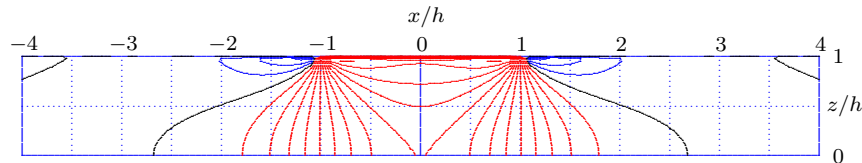

Figure 7.2: PSPL : Pore pressure, $ct/h^2 = 0.0001$.

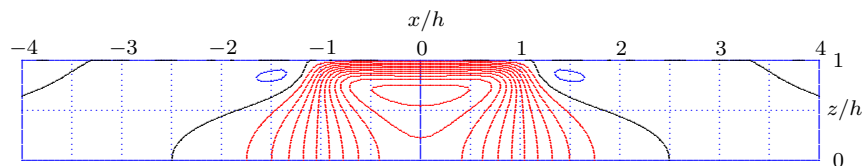

Figure 7.3: PSPL : Pore pressure, $ct/h^2 = 0.01$.

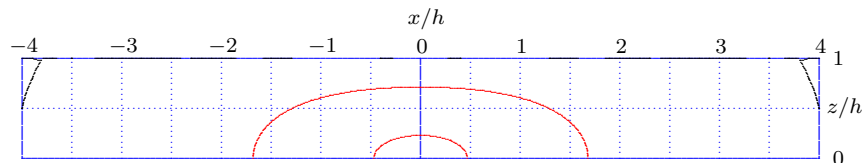

Figure 7.4: PSPL : Pore pressure, $ct/h^2 = 1$.

The maximum values of the pore pressure in these five figures are 0.6521, 0.5668, and 0.1059, respectively.

7.3.5 Initial pore pressure

As mentioned before, see section 1.9, and the previous chapter, the response of the pore pressure at the moment of loading should be equal to the response of an elastic material with the compression modulus K replaced by the undrained compression modulus K_u . In such an undrained analysis a practically infinite value for the compression modulus can be simulated by taking $\nu \rightarrow \frac{1}{2}$.

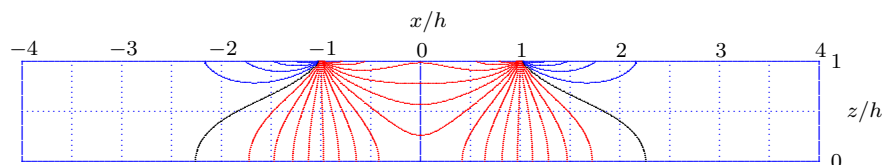

Figure 7.5: Initial pore pressures, from elastic solution.

For the present problem contours of the isotropic total stress in an elastic material with $\nu = \frac{1}{2}$ are shown in Figure 7.5. The maximum value of the pore pressure, calculated by a computer program for plane strain elastic computations (Filon), is $p/q = 0.7357$. Comparison with the results for a small value of time, as shown in Figure 7.2, indicates a good agreement, except in the immediate vicinity of the upper boundary, where consolidation has already reduced the pore pressures to zero.

7.3.6 The vertical total stress

It follows from equation (7.11) that

$$\frac{\bar{\sigma}_{zz}}{2G} = -\frac{\partial^2 \bar{D}}{\partial x^2} - z \frac{\partial^2 \bar{F}}{\partial z^2} + \phi \frac{\partial \bar{F}}{\partial z}, \quad (7.75)$$

With equations (7.35), (7.42) and (7.43) this is

$$\begin{aligned} \frac{\bar{\sigma}_{zz}}{2G} = & \int_0^\infty C_1 \xi^2 \cosh(z\xi) \cos(x\xi) d\xi + \int_0^\infty C_2 \xi^2 \cosh(z\xi) \cos(x\xi) d\xi \\ & - \int_0^\infty C_3 z \xi^2 \sinh(z\xi) \cos(x\xi) d\xi + \int_0^\infty \phi C_3 \xi \cosh(z\xi) \cos(x\xi) d\xi. \end{aligned} \quad (7.76)$$

Substituting the expressions (7.53), (7.56) and (7.57) into equation (7.76) gives

$$\begin{aligned} \frac{\bar{\sigma}_{zz}}{q} = & \frac{2}{\pi s} \int_0^\infty \frac{R \cosh(z\xi)}{Q\xi} \cos(x\xi) \sin(a\xi) d\xi \\ & + \frac{2}{\pi s} \int_0^\infty \frac{\phi'(h\xi) \sinh(h\xi) \cosh(h\xi) \cosh(z\xi)}{Q\xi} \cos(x\xi) \sin(a\xi) d\xi \\ & - \frac{2\eta h^2}{\pi c} \int_0^\infty \frac{(z/h) \sinh(h\xi) \sinh(z\xi) \cosh(h\xi)}{Q\xi} \cos(x\xi) \sin(a\xi) d\xi \\ & + \frac{2\phi\eta h^2}{\pi c} \int_0^\infty \frac{\sinh(h\xi) \cosh(z\xi) \cosh(h\xi)/(h\xi)}{Q\xi} \cos(x\xi) \sin(a\xi) d\xi. \end{aligned} \quad (7.77)$$

This equation can also be written as

$$\frac{\bar{\sigma}_{zz}}{q} = \int_0^\infty v(s) \cos(x\xi) \sin(a\xi) d\xi, \quad (7.78)$$

where, with equation (7.47), and rearranging terms,

$$\begin{aligned} v(s) = & \frac{2\eta h^2 \cosh(h\xi) \{ \cosh(h\xi) \cosh(z\xi) - (z/h) \sinh(h\xi) \sinh(z\xi) + \sinh(h\xi) \cosh(z\xi)/(h\xi) \}}{\pi c Q\xi} \\ & + \frac{2\phi' \cosh(h\xi) \{ (h\xi) \sinh(h\xi) \cosh(z\xi) - (h\xi) \sinh(h\xi) \cosh(z\xi) \}}{\pi s Q\xi}. \end{aligned} \quad (7.79)$$

It can easily be verified that this solution satisfies the boundary condition (7.19) for the vertical stress at the top of the layer, because for $z = h$ the expression (7.79) becomes

$$\begin{aligned} z = h : v(s) = & \frac{2\eta h^2 \cosh(h\xi) \{ 1 + \sinh(h\xi) \cosh(h\xi)/(h\xi) \}}{\pi c Q\xi} \\ & + \frac{2\phi' \cosh(h\xi) \{ (h\xi) \sinh(h\xi) \cosh(h\xi) - (h\xi) \sinh(h\xi) \cosh(h\xi) \}}{\pi s Q\xi}, \end{aligned} \quad (7.80)$$

and then using the expression (7.55) for the value of Q it follows that

$$z = h : v(s) = \frac{2}{\pi s \xi}, \quad (7.81)$$

which confirms that the boundary condition (7.19) is indeed satisfied.

The function $v(s)$ is the Laplace transform of a function $V(t)$,

$$v(s) = \int_0^\infty V(t) \exp(-st) dt. \quad (7.82)$$

The inverse Laplace transform of equation (7.78) is

$$\frac{\sigma_{zz}}{q} = \int_0^{\infty} V(t) \cos(x\xi) \sin(a\xi) d\xi. \quad (7.83)$$

The inverse Laplace transform $V(t)$ is again determined using Talbot's numerical method,

$$V(t) = \frac{2}{5} \sum_{k=0}^{M-1} \Re\left\{\gamma_k \frac{v(\delta_k/t)}{t}\right\}, \quad (7.84)$$

In this case

$$\begin{aligned} \frac{v(\delta_k/t)}{t} = \frac{2\eta h^2}{\pi ct} \frac{\cosh(h\xi)\{\cosh(h\xi)\cosh(z\xi) - (z/h)\sinh(h\xi)\sinh(z\xi) + \sinh(h\xi)\cosh(z\xi)/(h\xi)\}}{Q\xi} \\ + \frac{2\phi'}{\pi\delta_k} \frac{\cosh(h\xi)\{(h\xi)\sinh(h\xi)\cosh(z\xi) - (h\xi)\sinh(h\xi)\cosh(z\xi)\}}{Q\xi}. \end{aligned} \quad (7.85)$$

where

$$\zeta = \sqrt{\xi^2 + \lambda^2} = \sqrt{\xi^2 + s/c} = \sqrt{\xi^2 + \delta_k/ct}. \quad (7.86)$$

Using dimensionless variables $u = h\xi$, $x' = x/h$, $z' = z/h$, $a' = a/h$, $\tau = ct/h^2$ and $u' = \sqrt{u^2 + \delta_k/\tau}$ the integral (7.83) can be written as

$$\frac{\sigma_{zz}}{q} = \frac{2}{5} \int_0^{\infty} \sum_{k=0}^{M-1} \Re\left\{\gamma_k \frac{v(\delta_k/t)}{ht}\right\} \cos(x'u) \frac{\sin(a'u)}{u} du, \quad (7.87)$$

where the dimensionless form of equation (7.85) is

$$\begin{aligned} \frac{v(\delta_k/t)}{ht} = \frac{2\eta}{\pi\tau} \frac{\cosh(u')\{\cosh(u)\cosh(z'u) - z'\sinh(u)\sinh(z'u) + \sinh(u)\cosh(z'u)/(u)\}}{Q} \\ + \frac{2\phi'}{\pi\delta_k} \frac{\cosh(u)\{u\sinh(u)\cosh(z'u) - (u')\sinh(u')\cosh(z'u)\}}{Q}. \end{aligned} \quad (7.88)$$

It should be noted that the factor u in the denominator of equation (7.88) has been transferred to the integral (7.87). This integral can be calculated numerically by the program PSPL (Plane Strain Poroelastic Layer).

As before, the factors $\sinh(u)$ and $\cosh(u)$ in the program PSPL have been replaced by factors $1 - \exp(-2u)$ and $1 + \exp(2u)$ both in the denominator and the numerator, to improve the accuracy of the computations.

Examples

For three values of the time parameter ct/h^2 the distribution of vertical total stresses is shown in the figures 7.6, 7.7, and 7.8, shown below. The figures have been produced assuming that $\nu = 0$, $S = 0$ and $\alpha = 1$. The number of pixels in each direction has been taken as $NP = 100$. For smaller values of NP , say $NP = 20$, the accuracy is somewhat less, but the computations are faster, of course.

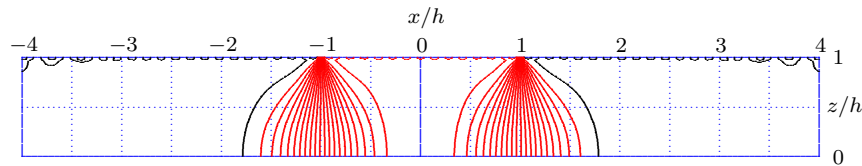
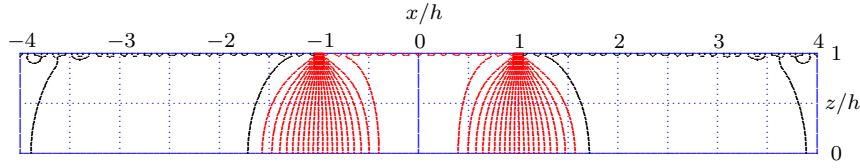
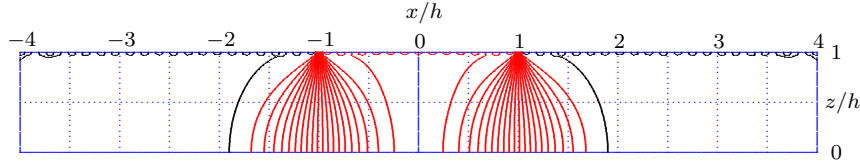

Figure 7.6: PSPL : Vertical total stress, $ct/h^2 = 0.01$.

The maximum values of the stress in these four figures are 1.0515, 1.0814, and 1.0286, respectively. As the maximum value of the stress can be expected to be 1.0000, the results indicate that the errors are about 5 %. These errors seem to be concentrated near the upper boundary, where some of the factors in the solution are very large, and the limiting values (0 or 1) are not easy to obtain from the numerical process.

It is interesting to observe that the vertical total stresses are practically independent of time, in agreement with a suggestion first made by Rendulic (1936).

Figure 7.7: PSPL : Vertical total stress, $ct/h^2 = 0.1$.Figure 7.8: PSPL : Vertical total stress, $ct/h^2 = 1$.

7.3.7 The elastic limit

It can be expected that for $t \rightarrow \infty$ the pore pressures will have completely dissipated. The solution then should be reduced to the solution of the problem of an infinite elastic strip (Filon's problem). This can be verified as follows.

The limiting value of the vertical normal stress in the poroelastic problem can be determined using the property of Laplace transforms (Churchill, 1972) that

$$\lim_{t \rightarrow \infty} \frac{\sigma_{zz}}{q} = \lim_{s \rightarrow 0} \frac{s \bar{\sigma}_{zz}}{q}. \quad (7.89)$$

With equation (7.78) this gives

$$\lim_{t \rightarrow \infty} \frac{\sigma_{zz}}{q} = \lim_{s \rightarrow 0} \int_0^\infty s v(s) \cos(x\xi) \sin(a\xi) d\xi. \quad (7.90)$$

For $s = 0$ it follows from equation (7.86) that $\zeta = \xi$, and from equation (7.79) it then follows that

$$v(s) = \frac{2\eta h^2 \cosh(h\xi) \{ \cosh(h\xi) \cosh(z\xi) - (z/h) \sinh(h\xi) \sinh(z\xi) + \sinh(h\xi) \cosh(z\xi) / (h\xi) \}}{\pi c Q \xi}, \quad (7.91)$$

where, from equation (7.55) with $s \rightarrow 0$,

$$Q = \frac{\eta h^2 s}{c} \cosh(h\xi) \{ 1 + \sinh(h\xi) \cosh(h\xi) / (h\xi) \}. \quad (7.92)$$

Using the dimensionless variables $u = h\xi$, $z' = z/h$, $x' = x/h$, and $a' = a/h$, so that $d\xi/\xi = du/u$, it now

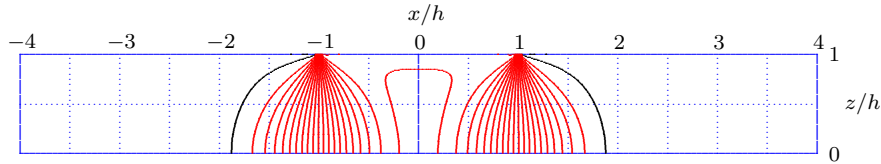

Figure 7.9: Filon's problem, vertical stress.

follows from equation (7.90) that

$$\lim_{t \rightarrow \infty} \frac{\sigma_{zz}}{q} = \frac{2}{\pi} \frac{\sinh(u) \cosh(z'u) + u \cosh(u) \cosh(z'u) - z'u \sinh(u) \sinh(z'u)}{u^2 + u \sinh(u) \cosh(u)} \cos(x'u) \sin(a'u) du. \quad (7.93)$$

Except for some differences in notation this is precisely the solution given by Sneddon (1951), which was first derived by Filon (1903). The results are shown in Figure 7.9, as contours of the vertical stress. As expected, the general shape of the contours is very similar to the shape of the contours obtained earlier in this chapter for the poroelastic solution.

7.3.8 The horizontal total stress

It follows from equation (7.10) that

$$\frac{\bar{\sigma}_{xx}}{2G} = -\frac{\partial^2 \bar{D}}{\partial z^2} - z \frac{\partial^2 \bar{F}}{\partial x^2} + (2 - \phi) \frac{\partial \bar{F}}{\partial z}, \quad (7.94)$$

With equations (7.36), (7.41) and (7.43) this gives

$$\begin{aligned} \frac{\bar{\sigma}_{xx}}{2G} = & -\int_0^\infty C_1 \xi^2 \cosh(z\xi) \cos(x\xi) d\xi - \int_0^\infty C_2 \zeta^2 \cosh(z\zeta) \cos(x\xi) d\xi \\ & + \int_0^\infty C_3 z \xi^2 \sinh(z\xi) \cos(x\xi) d\xi + (2 - \phi) \int_0^\infty C_3 \xi \cosh(z\xi) \cos(x\xi) d\xi. \end{aligned} \quad (7.95)$$

Substituting the expressions (7.53), (7.56) and (7.57) into equation (7.95) gives

$$\begin{aligned} \frac{\bar{\sigma}_{xx}}{q} = & -\frac{2}{\pi s} \int_0^\infty \frac{R \cosh(z\xi)}{Q\xi} \cos(x\xi) \sin(a\xi) d\xi \\ & + \frac{2}{\pi s} \int_0^\infty \frac{\phi'(h\xi) \zeta^2 \sinh(h\xi) \cosh(h\xi) \cosh(z\zeta)}{Q\xi^3} \cos(x\xi) \sin(a\xi) d\xi \\ & + \frac{2\eta h^2}{\pi c} \int_0^\infty \frac{(z/h) \sinh(h\xi) \sinh(z\xi) \cosh(h\zeta)}{Q\xi} \cos(x\xi) \sin(a\xi) d\xi \\ & + \frac{2(2 - \phi)\eta h^2}{\pi c} \int_0^\infty \frac{\sinh(h\xi) \cosh(z\xi) \cosh(h\zeta)/(h\xi)}{Q\xi} \cos(x\xi) \sin(a\xi) d\xi. \end{aligned} \quad (7.96)$$

This equation can also be written as

$$\frac{\bar{\sigma}_{xx}}{q} = \int_0^\infty v(s) \cos(x\xi) \sin(a\xi) d\xi, \quad (7.97)$$

where, with equation (7.47), and rearranging terms,

$$\begin{aligned} v(s) = & \frac{2\eta h^2 \cosh(h\zeta) \{(z/h) \sinh(h\xi) \sinh(z\xi) - \cosh(h\xi) \cosh(z\xi) + \sinh(h\xi) \cosh(z\xi)/(h\xi)\}}{\pi c Q\xi} \\ & + \frac{2\phi' \cosh(h\xi) \{(h\zeta) \sinh(h\zeta) \cosh(z\xi) - (h\zeta^2/\xi) \sinh(h\xi) \cosh(z\zeta)\}}{\pi s Q\xi}. \end{aligned} \quad (7.98)$$

The function $v(s)$ is the Laplace transform of a function $V(t)$,

$$v(s) = \int_0^\infty V(t) \exp(-st) dt. \quad (7.99)$$

The inverse Laplace transform of equation (7.97) is

$$\frac{\sigma_{xx}}{q} = \int_0^\infty V(t) \cos(x\xi) \sin(a\xi) d\xi. \quad (7.100)$$

The inverse Laplace transform $V(t)$ of the function $v(s)$ can be determined (approximately) using Talbot's numerical method,

$$V(t) = \frac{2}{5} \sum_{k=0}^{M-1} \Re \left\{ \gamma_k \frac{v(\delta_k/t)}{t} \right\}. \quad (7.101)$$

In this case

$$\begin{aligned} \frac{v(\delta_k/t)}{t} = & \frac{2\eta h^2 \cosh(h\zeta) \{(z/h) \sinh(h\xi) \sinh(z\xi) - \cosh(h\xi) \cosh(z\xi) + \sinh(h\xi) \cosh(z\xi)/(h\xi)\}}{\pi c t Q\xi} \\ & + \frac{2\phi' \cosh(h\xi) \{(h\zeta) \sinh(h\zeta) \cosh(z\xi) - (h\zeta^2/\xi) \sinh(h\xi) \cosh(z\zeta)\}}{\pi \delta_k Q\xi}, \end{aligned} \quad (7.102)$$

where

$$\zeta = \sqrt{\xi^2 + \lambda^2} = \sqrt{\xi^2 + s/c} = \sqrt{\xi^2 + \delta_k/ct}. \quad (7.103)$$

Using dimensionless variables $u = h\xi$, $x' = x/h$, $z' = z/h$, $a' = a/h$, $\tau = ct/h^2$ and $u' = \sqrt{u^2 + \delta_k/\tau}$ the integral (7.100) can be written as

$$\frac{\sigma_{xx}}{q} = \frac{2}{5} \int_0^\infty \sum_{k=0}^{M-1} \Re\left\{\gamma_k \frac{v(\delta_k/t)}{ht}\right\} \cos(x'u) \frac{\sin(a'u)}{u} du, \quad (7.104)$$

where the dimensionless form of equation (7.102) is

$$\begin{aligned} \frac{v(\delta_k/t)}{ht} = & \frac{2\eta \cosh(u') \{z' \sinh(u) \sinh(z'u) - \cosh(u) \cosh(z'u) + \sinh(u) \cosh(z'u)/u\}}{\pi\tau Q} \\ & + \frac{2\phi' \cosh(u) \{u' \sinh(u') \cosh(z'u) - (u')^2 \sinh(u) \cosh(z'u)/u\}}{\pi\delta_k Q}. \end{aligned} \quad (7.105)$$

It should be noted that the factor u in the denominator of equation (7.105) has been transferred to the integral (7.104). This integral can be calculated numerically by the program PSPL (Plane Strain Poroelastic Layer). The results for two values of time are shown in Figure 7.10 and Figure 7.11, again for $\nu = 0$, $S = 0$, $\alpha = 1$ and $NP = 100$.

As before, the factors $\sinh(u)$ and $\cosh(u)$ in the program PSPL have been replaced by factors $1 - \exp(-2u)$ and $1 + \exp(2u)$ both in the denominator and the numerator, to improve the accuracy of the computations.

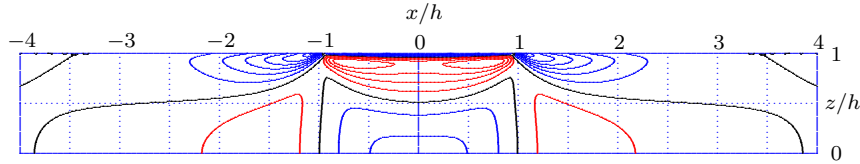

Figure 7.10: PSPL : Horizontal total stress, $ct/h^2 = 0.001$.

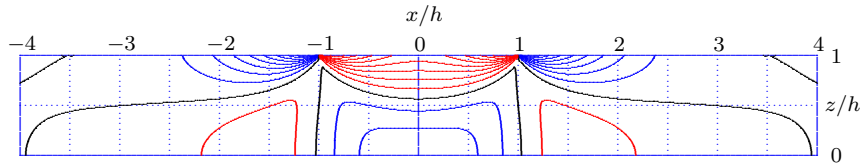

Figure 7.11: PSPL : Horizontal total stress, $ct/h^2 = 10$.

7.3.9 The elastic limit

As before, it can be expected that for $t \rightarrow \infty$ the pore pressures will have completely dissipated, so that the solution will be reduced to the solution of Filon's problem of an infinite elastic strip. This can be verified as follows.

The limiting value of the horizontal normal stress in the poroelastic problem can be determined using the property of Laplace transforms (Churchill, 1972) that

$$\lim_{t \rightarrow \infty} \frac{\sigma_{xx}}{q} = \lim_{s \rightarrow 0} \frac{s \bar{\sigma}_{xx}}{q}. \quad (7.106)$$

With equation (7.97) this gives

$$\lim_{t \rightarrow \infty} \frac{\sigma_{xx}}{q} = \lim_{s \rightarrow 0} \int_0^\infty s v(s) \cos(x\xi) \sin(a\xi) d\xi. \quad (7.107)$$

From equation (7.103) it follows that for $s = 0$: $\zeta = \xi$, and then equation (7.98) reduces to

$$v(s) = \frac{2\eta h^2 \cosh(h\xi) \{-\cosh(h\xi) \cosh(z\xi) + (z/h) \sinh(h\xi) \sinh(z\xi) + \sinh(h\xi) \cosh(z\xi)/(h\xi)\}}{\pi c Q\xi}, \quad (7.108)$$

where, from equation (7.92),

$$Q = \frac{\eta h^2 s}{c} \cosh(h\xi) \{1 + \sinh(h\xi) \cosh(h\xi)/(h\xi)\}. \quad (7.109)$$

Using the dimensionless variables $u = h\xi$, $z' = z/h$, $x' = x/h$, and $a' = a/h$, so that $d\xi/\xi = du/u$, it now

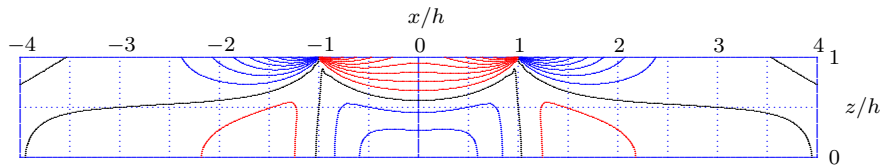

Figure 7.12: Filon's problem, horizontal stress.

follows from equation (7.107) that

$$\lim_{t \rightarrow \infty} \frac{\sigma_{xx}}{q} = \frac{2}{\pi} \frac{\sinh(u) \cosh(z'u) - u \cosh(u) \cosh(z'u) + z'u \sinh(u) \sinh(z'u)}{u^2 + u \sinh(u) \cosh(u)} \cos(x'u) \sin(a'u) du. \quad (7.110)$$

This is in agreement with the solution given by Sneddon (1951), see also Filon (1903). The results are shown in Figure 7.12, as contours of the horizontal stress. As expected, the general shape of the contours is very similar to the shape of the contours obtained earlier in this chapter from the poroelastic solution.

7.3.10 The shear stress

It follows from equation (7.12) that

$$\frac{\bar{\sigma}_{xz}}{2G} = \frac{\partial^2 \bar{D}}{\partial x \partial z} - z \frac{\partial^2 \bar{F}}{\partial x \partial z} - (1 - \phi) \frac{\partial \bar{F}}{\partial x}. \quad (7.111)$$

With equations (7.39), (7.44) and (7.40) this gives

$$\begin{aligned} \frac{\bar{\sigma}_{xz}}{2G} = & - \int_0^\infty C_1 \xi^2 \sinh(z\xi) \sin(x\xi) d\xi - \int_0^\infty C_2 z \xi \sinh(z\xi) \sin(x\xi) d\xi \\ & + \int_0^\infty C_3 z \xi^2 \cosh(z\xi) \sin(x\xi) d\xi + (1 - \phi) \int_0^\infty C_3 \xi \sinh(z\xi) \sin(x\xi) d\xi. \end{aligned} \quad (7.112)$$

Substituting the expressions (7.53), (7.56) and (7.57) into equation (7.112) gives

$$\begin{aligned} \frac{\bar{\sigma}_{xz}}{q} = & - \frac{2}{\pi s} \int_0^\infty \frac{R \sinh(z\xi)}{Q\xi} \sin(x\xi) \sin(a\xi) d\xi \\ & - \frac{2}{\pi s} \int_0^\infty \frac{\phi'(h\zeta) \sinh(h\xi) \cosh(h\xi) \sinh(z\xi)}{Q\xi} \sin(x\xi) \sin(a\xi) d\xi \\ & + \frac{2\eta h^2}{\pi c} \int_0^\infty \frac{(z/h) \sinh(h\xi) \cosh(z\xi) \cosh(h\zeta)}{Q\xi} \sin(x\xi) \sin(a\xi) d\xi \\ & + \frac{2(1 - \phi)\eta h^2}{\pi c} \int_0^\infty \frac{\sinh(h\xi) \sinh(z\xi) \cosh(h\zeta)/(h\xi)}{Q\xi} \sin(x\xi) \sin(a\xi) d\xi. \end{aligned} \quad (7.113)$$

This equation can also be written as

$$\frac{\bar{\sigma}_{xz}}{q} = \int_0^\infty v(s) \sin(x\xi) \sin(a\xi) d\xi, \quad (7.114)$$

where, with equation (7.47), and rearranging terms,

$$\begin{aligned} v(s) = & \frac{2\eta h^2 \cosh(h\zeta) \{(z/h) \sinh(h\xi) \cosh(z\xi) - \cosh(h\xi) \sinh(z\xi)\}}{\pi c Q\xi} \\ & + \frac{2\phi'(h\zeta) \cosh(h\xi) \{\sinh(h\zeta) \sinh(z\xi) - \sinh(h\xi) \sinh(z\xi)\}}{\pi s Q\xi}. \end{aligned} \quad (7.115)$$

The function $v(s)$ is the Laplace transform of a function $V(t)$,

$$v(s) = \int_0^{\infty} V(t) \exp(-st) dt. \quad (7.116)$$

The inverse Laplace transform of equation (7.114) is

$$\frac{\sigma_{xz}}{q} = \int_0^{\infty} V(t) \sin(x\xi) \sin(a\xi) d\xi. \quad (7.117)$$

The inverse Laplace transform $V(t)$ of the function $v(s)$ can be determined (approximately) using Talbot's numerical method,

$$V(t) = \frac{2}{5} \sum_{k=0}^{M-1} \Re\left\{ \gamma_k \frac{v(\delta_k/t)}{t} \right\}. \quad (7.118)$$

In this case

$$\begin{aligned} \frac{v(\delta_k/t)}{t} = \frac{2\eta h^2 \cosh(h\zeta) \{ (z/h) \sinh(h\xi) \cosh(z\xi) - \cosh(h\xi) \sinh(z\xi) \}}{\pi ct Q\xi} \\ + \frac{2\phi' (h\zeta) \cosh(h\xi) \{ \sinh(h\zeta) \sinh(z\xi) - \sinh(h\xi) \sinh(z\xi) \}}{\pi \delta_k Q\xi}, \end{aligned} \quad (7.119)$$

where

$$\zeta = \sqrt{\xi^2 + \lambda^2} = \sqrt{\xi^2 + s/c} = \sqrt{\xi^2 + \delta_k/ct}. \quad (7.120)$$

Using dimensionless variables $u = h\xi$, $x' = x/h$, $z' = z/h$, $a' = a/h$, $\tau = ct/h^2$ and $u' = \sqrt{u^2 + \delta_k/\tau}$ the integral (7.117) can be written as

$$\frac{\sigma_{xz}}{q} = \frac{2}{5} \int_0^{\infty} \sum_{k=0}^{M-1} \Re\left\{ \gamma_k \frac{v(\delta_k/t)}{ht} \right\} \sin(x'u) \frac{\sin(a'u)}{u} du, \quad (7.121)$$

where the dimensionless form of equation (7.119) is

$$\begin{aligned} \frac{v(\delta_k/t)}{ht} = \frac{2\eta \cosh(u') \{ z' \sinh(u) \cosh(z'u) - \cosh(u) \sinh(z'u) \}}{\pi \tau Q} \\ + \frac{2\phi' u' \cosh(u) \{ \sinh(u') \sinh(z'u) - \sinh(u) \sinh(z'u') \}}{\pi \delta_k Q}. \end{aligned} \quad (7.122)$$

It should be noted that the factor u in the denominator of equation (7.122) has again been transferred to the integral (7.121). This integral can be calculated numerically by the program PSPL (Plane Strain Poroelastic Layer). The results for two values of time are shown in Figure 7.13 and Figure 7.14, again for $\nu = 0$, $S = 0$, $\alpha = 1$ and $NP = 100$. As before, the factors $\sinh(u)$ and $\cosh(u)$ in the program PSPL have been replaced by factors $1 - \exp(-2u)$ and $1 + \exp(2u)$ both in the denominator and the numerator, to improve the accuracy of the computations.

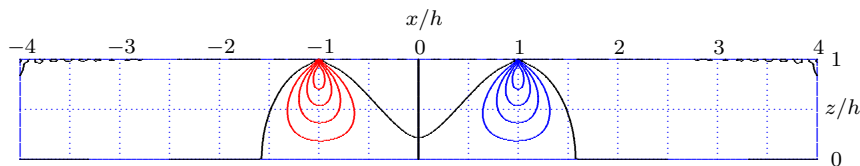
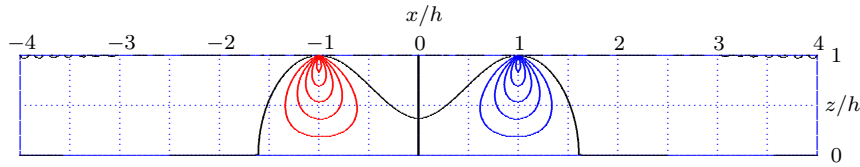

Figure 7.13: PSPL : Shear stress, $ct/h^2 = 0.001$.

Figure 7.14: PSPL : Shear stress, $ct/h^2 = 10$.

7.3.11 The elastic limit

As in earlier sections on the vertical and horizontal total stress, it can be expected that for $t \rightarrow \infty$ the pore pressures will have completely dissipated, so that the solution will then be reduced to the solution of Filon's problem of an infinite elastic strip. This can be verified as follows.

The limiting value of the shear stress in the poroelastic problem can be determined using the property of Laplace transforms (Churchill, 1972) that

$$\lim_{t \rightarrow \infty} \frac{\sigma_{xz}}{q} = \lim_{s \rightarrow 0} \frac{s \bar{\sigma}_{xz}}{q}. \quad (7.123)$$

With equation (7.114) this gives

$$\lim_{t \rightarrow \infty} \frac{\sigma_{xz}}{q} = \lim_{s \rightarrow 0} \int_0^{\infty} s v(s) \cos(x\xi) \sin(a\xi) d\xi. \quad (7.124)$$

For $s = 0$ it follows from equation (7.120) that $\zeta = \xi$, and from equation (7.115) it then follows that

$$v(s) = \frac{2\eta h^2 \cosh(h\xi) \{(z/h) \sinh(h\xi) \cosh(z\xi) - \cosh(h\xi) \sinh(z\xi)\}}{\pi c Q \xi}, \quad (7.125)$$

where, from equation (7.92),

$$Q = \frac{\eta h^2 s}{c} \cosh(h\xi) \{1 + \sinh(h\xi) \cosh(h\xi)/(h\xi)\}. \quad (7.126)$$

Using the dimensionless variables $u = h\xi$, $z' = z/h$, $x' = x/h$, and $a' = a/h$, so that $d\xi/\xi = du/u$, it now

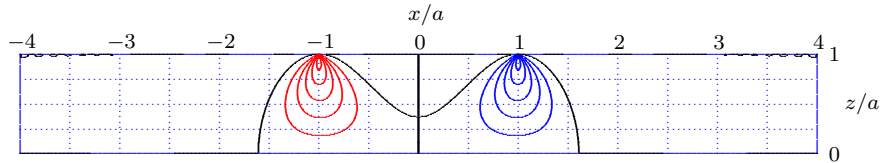

Figure 7.15: Filon's problem, Shear stress.

follows from equation (7.124) that

$$\lim_{t \rightarrow \infty} \frac{\sigma_{xz}}{q} = -\frac{2}{\pi} \frac{\cosh(u) \sinh(z'u) - z' \sinh(u) \cosh(z'u)}{u + \sinh(u) \cosh(u)} \sin(x'u) \sin(a'u) du. \quad (7.127)$$

This is in agreement with the solution given by Sneddon (1951), see also Filon (1903). The results are shown in Figure 7.15, as contours of the shear stress. As expected, the general shape of the contours is very similar to the shape in the figures obtained earlier in this chapter from the poroelastic solution.

7.3.12 The isotropic total stress

It follows from equation (7.13) that the Laplace transform of the isotropic total stress is

$$\frac{\bar{\sigma}_0}{2G} = -\frac{2}{3} \nabla^2 \bar{D} + \frac{1}{3} (4 - \phi) \frac{\partial \bar{F}}{\partial z}. \quad (7.128)$$

With equations (7.37) and (7.43) this gives

$$\frac{\bar{\sigma}_0}{2G} = -\frac{2}{3} \int_0^{\infty} C_2 \lambda^2 \cosh(z\zeta) \cos(x\xi) d\xi + \frac{1}{3} (4 - \phi) \int_0^{\infty} C_3 \xi \cosh(z\xi) \cos(x\xi) d\xi. \quad (7.129)$$

Substituting the expressions (7.53) and (7.57) into equation (7.129) gives

$$\begin{aligned} \frac{\bar{\sigma}_0}{q} = & -\frac{4\phi'h^2}{3\pi c} \int_0^\infty \frac{\sinh(h\xi) \cosh(h\xi) \cosh(z\xi)}{Q\xi(h\xi)} \sin(a\xi) \cos(x\xi) d\xi \\ & + \frac{2\eta(4-\phi)h^2}{3\pi c} \int_0^\infty \frac{\sinh(h\xi) \cosh(z\xi) \cosh(h\xi)}{Q\xi(h\xi)} \sin(a\xi) \cos(x\xi) d\xi. \end{aligned} \quad (7.130)$$

This equation can also be written as

$$\frac{\bar{\sigma}_0}{q} = \int_0^\infty v(s) \sin(a\xi) \cos(x\xi) d\xi, \quad (7.131)$$

where

$$v(s) = -\frac{4\phi'h^2}{3\pi c} \frac{\sinh(h\xi) \cosh(h\xi) \cosh(z\xi)}{Q\xi(h\xi)} + \frac{2\eta(4-\phi)h^2}{3\pi c} \frac{\sinh(h\xi) \cosh(z\xi) \cosh(h\xi)}{Q\xi(h\xi)}. \quad (7.132)$$

The function $v(s)$ is the Laplace transform of a function $V(t)$,

$$v(s) = \int_0^\infty V(t) \exp(-st) dt. \quad (7.133)$$

The inverse Laplace transform of equation (7.131) is

$$\frac{\sigma_0}{q} = \int_0^\infty V(t) \cos(x\xi) \sin(a\xi) d\xi. \quad (7.134)$$

The inverse Laplace transform $V(t)$ of the function $v(s)$ can be determined (approximately) using Talbot's numerical method,

$$V(t) = \frac{2}{5} \sum_{k=0}^{M-1} \Re\left\{ \gamma_k \frac{v(\delta_k/t)}{t} \right\}. \quad (7.135)$$

In this case

$$\frac{v(\delta_k/t)}{t} = -\frac{4\phi'h^2}{3\pi ct} \frac{\sinh(h\xi) \cosh(h\xi) \cosh(z\xi)}{Q\xi(h\xi)} + \frac{2\eta(4-\phi)h^2}{3\pi ct} \frac{\sinh(h\xi) \cosh(z\xi) \cosh(h\xi)}{Q\xi(h\xi)}. \quad (7.136)$$

where

$$\zeta = \sqrt{\xi^2 + \lambda^2} = \sqrt{\xi^2 + s/c} = \sqrt{\xi^2 + \delta_k/ct}. \quad (7.137)$$

Using dimensionless variables $u = h\xi$, $x' = x/h$, $z' = z/h$, $a' = a/h$, $\tau = ct/h^2$ and $u' = \sqrt{u^2 + \delta_k/\tau}$ the integral (7.134) can be written as

$$\frac{\sigma_0}{q} = \frac{2}{5} \int_0^\infty \sum_{k=0}^{M-1} \Re\left\{ \gamma_k \frac{v(\delta_k/t)}{ht} \right\} \cos(x'u) \frac{\sin(a'u)}{u} du, \quad (7.138)$$

where the dimensionless form of equation (7.136) is

$$\frac{v(\delta_k/t)}{ht} = -\frac{4\phi'}{3\pi\tau} \frac{\sinh(u) \cosh(u) \cosh(z'u)}{Qu} + \frac{2\eta(4-\phi)}{3\pi\tau} \frac{\sinh(u) \cosh(z'u) \cosh(u)}{Qu}. \quad (7.139)$$

It should be noted that a factor u in the denominator of equation (7.139) has been transferred to the integral (7.138). This integral can be calculated numerically by the program PSPL (Plane Strain Poroelastic Layer). The results for three values of time are shown in Figure 7.16, Figure 7.17, and Figure 7.18, again for $\nu = 0$, $S = 0$, $\alpha = 1$ and $NP = 100$.

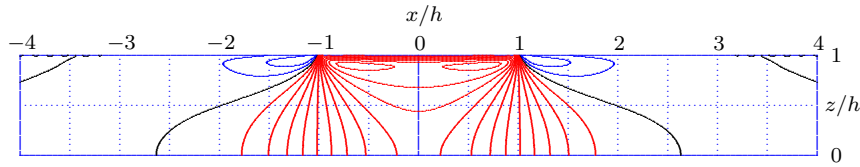
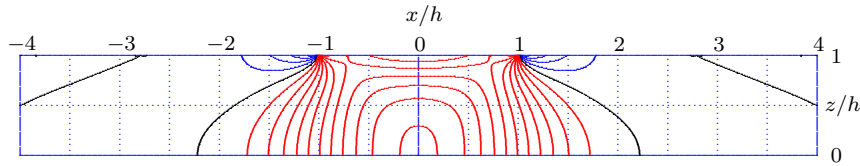
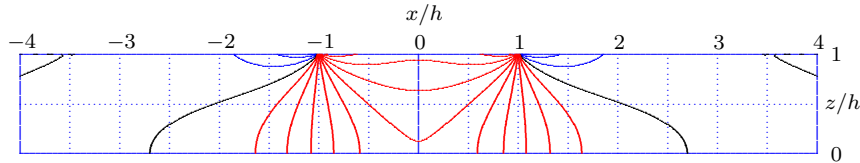
Figure 7.16: PSPL : Isotropic total stress, $ct/h^2 = 0.001$.Figure 7.17: PSPL : Isotropic total stress, $ct/h^2 = 0.1$.Figure 7.18: PSPL : Isotropic total stress, $ct/h^2 = 10$.

7.3.13 The elastic limit

The limiting value of the isotropic total stress if the pore pressures have been fully dissipated, for $t \rightarrow \infty$ can be determined, using the property of Laplace transforms (Churchill, 1972) that

$$\lim_{t \rightarrow \infty} \frac{\sigma_0}{q} = \lim_{s \rightarrow 0} \frac{s \bar{\sigma}_0}{q}. \quad (7.140)$$

With equation (7.131) this gives

$$\lim_{t \rightarrow \infty} \frac{\sigma_0}{q} = \lim_{s \rightarrow 0} \int_0^\infty s v(s) \cos(x\xi) \sin(a\xi) d\xi. \quad (7.141)$$

For $s = 0$ it follows from equation (7.137) that $\zeta = \xi$, and from equation (7.132) it then follows that

$$v(s) = -\frac{4\phi'h^2 - 2\eta(4 - \phi)h^2}{3\pi c} \frac{\sinh(h\xi) \cosh(h\xi) \cosh(z\xi)}{Q\xi(h\xi)}. \quad (7.142)$$

where

$$Q = \frac{\eta h^2 s}{c} \cosh(h\xi) \{1 + \sinh(h\xi) \cosh(h\xi)/(h\xi)\}. \quad (7.143)$$

Using the dimensionless variables $u = h\xi$, $z' = z/h$, $x' = x/h$, and $a' = a/h$, so that $d\xi/\xi = du/u$, it now

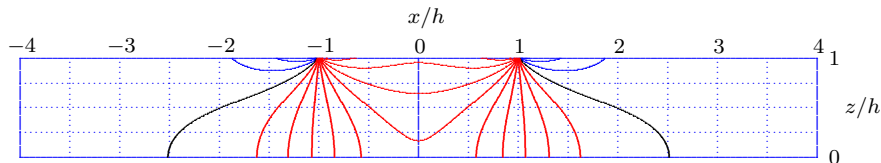
Figure 7.19: Elastic layer, Isotropic stress, $\nu = 0$.

follows from equation (7.141) that

$$\lim_{t \rightarrow \infty} \frac{\sigma_0}{q} = -\frac{2(1 + \nu)}{3\pi(1 - \nu)} \frac{\sinh(u) \cosh(z'u)}{u + \sinh(u) \cosh(u)} \cos(x'u) \sin(a'u) du. \quad (7.144)$$

This is in agreement with the solution given by Sneddon (1951), see also Filon (1903). The results are shown in Figure 7.19, as contours of the isotropic total stress. As expected, the general shape of the contours is very similar to the shape in the figures obtained earlier in this chapter for the poroelastic solution.

7.4 The vertical displacement

In the previous sections the pore pressure and the stresses have been calculated. The displacements are also of interest, of course. These are considered in this section.

The Laplace transform of the vertical displacement is given by the Laplace transform of equation (7.2),

$$\bar{u}_z = -\frac{\partial \bar{D}}{\partial z} + z \frac{\partial \bar{F}}{\partial z} + (1 - 2\phi)\bar{F}. \quad (7.145)$$

The three terms in this expression are given by equations (7.34), (7.43) and (7.32),

$$\frac{\partial \bar{D}}{\partial z} = \int_0^\infty \{C_1 \xi \sinh(z\xi) + C_2 \zeta \sinh(z\zeta)\} \cos(x\xi) d\xi, \quad (7.146)$$

$$\frac{\partial \bar{F}}{\partial z} = \int_0^\infty C_3 \xi \cosh(z\xi) \cos(x\xi) d\xi, \quad (7.147)$$

$$\bar{F} = \int_0^\infty C_3 \sinh(z\xi) \cos(x\xi) d\xi. \quad (7.148)$$

The three constants C_1 , C_2 and C_3 are given by equations (7.56), (7.53) and (7.57),

$$C_1 = \frac{q}{\pi G s \xi^3} \frac{R}{Q} \sin(a\xi), \quad (7.149)$$

$$C_2 = \frac{q}{\pi G s \xi^3} \frac{\phi'(h\xi) \sinh(h\xi) \cosh(h\xi)}{Q} \sin(a\xi), \quad (7.150)$$

$$C_3 h = \frac{q}{\pi G s \xi^3} \frac{\eta(h\lambda)^2 \sinh(h\xi) \cosh(h\zeta)}{Q} \sin(a\xi), \quad (7.151)$$

where the expressions Q and R are defined in equations (7.55) and (7.47),

$$Q = \eta(h\lambda)^2 \cosh(h\zeta) \{1 + \sinh(h\xi) \cosh(h\xi)/(h\xi)\} \\ + \phi' \cosh(h\xi) \{ (h\xi) \sinh(h\xi) \cosh(h\zeta) - (h\zeta) \sinh(h\zeta) \cosh(h\xi) \}, \quad (7.152)$$

$$R = \eta(h\lambda)^2 \cosh(h\zeta) \{ (1 - \phi) \sinh(h\xi)/(h\xi) + \cosh(h\xi) \} - \phi'(h\zeta) \sinh(h\zeta) \cosh(h\xi). \quad (7.153)$$

The vertical displacement u_z will be denoted by $-w$, because it can be expected that the vertical displacement is in the direction of the load on the surface. Using the expressions for the constants C_1 , C_2 and C_3 it follows from equation (7.145) that this can be written as

$$\frac{\bar{w}G}{hq} = \frac{1}{\pi s} \int_0^\infty \frac{R \sinh(z\xi)}{Q h \xi^2} \sin(a\xi) \cos(x\xi) d\xi, \\ + \frac{1}{\pi s} \int_0^\infty \frac{\phi'(h\zeta) \sinh(z\zeta) \sinh(h\xi) \cosh(h\xi)}{Q h \xi^2} \sin(a\xi) \cos(x\xi) d\xi, \\ - \frac{\eta h^2}{\pi c} \int_0^\infty \frac{(z/h) \sinh(h\xi) \cosh(h\zeta) \cosh(z\xi)}{Q h \xi^2} \sin(a\xi) \cos(x\xi) d\xi, \\ - \frac{\eta(1 - 2\phi)h^2}{\pi c} \int_0^\infty \frac{\cosh(h\zeta) \sinh(z\xi) \sinh(h\xi)}{Q h^2 \xi^3} \sin(a\xi) \cos(x\xi) d\xi. \quad (7.154)$$

Substitution of equation (7.153) into equation (7.154) now gives, after some rearrangement of terms,

$$\frac{\bar{w}G}{hq} = \int_0^\infty b(s) \sin(a\xi) \cos(x\xi) d\xi, \quad (7.155)$$

where

$$b(s) = \frac{\phi \eta h^2 \sinh(z\xi) \cosh(h\zeta) \sinh(h\xi)}{\pi c} \frac{1}{Q(h^2 \xi^3)} \\ + \frac{\eta h^2 \cosh(h\zeta) [\sinh(z\xi) \cosh(h\xi) - (z/h) \sinh(h\xi) \cosh(z\xi)]}{\pi c} \frac{1}{Q h \xi^2} \\ + \frac{1}{\pi s} \frac{\phi'(h\zeta) \cosh(h\xi) [\sinh(z\zeta) \sinh(h\xi) - \sinh(z\xi) \sinh(h\zeta)]}{Q h \xi^2}. \quad (7.156)$$

The function $b(s)$ is the Laplace transform of a function $B(t)$,

$$b(s) = \int_0^{\infty} B(t) \exp(-st) dt. \quad (7.157)$$

The inverse Laplace transform of equation (7.155) is

$$\frac{wG}{hq} = \int_0^{\infty} B(t) \sin(a\xi) \cos(x\xi) d\xi. \quad (7.158)$$

The Talbot algorithm for the calculation of the inverse Laplace transform $B(t)$ is

$$B(t) = \frac{2}{5} \sum_{k=0}^{M-1} \Re\left\{ \gamma_k \frac{b(\delta_k/t)}{t} \right\}, \quad (7.159)$$

where M is an integer indicating the number of terms in the approximation (e.g. $M = 10$ or $M = 20$), and where

$$\delta_0 = \frac{2M}{5}, \quad \delta_k = \frac{2k\pi}{5} [\cot(k\pi/M) + i], \quad 0 < k < M, \quad (7.160)$$

$$\gamma_0 = \frac{\exp(\delta_0)}{2}, \quad \gamma_k = \left\{ 1 + i(k\pi/M)(1 + [\cot(k\pi/M)]^2) - i \cot(k\pi/M) \right\} \exp(\delta_k), \quad 0 < k < M. \quad (7.161)$$

In the problem considered here

$$\begin{aligned} \frac{b(\delta_k/t)}{t} &= \frac{\phi\eta h^2 \sinh(z\xi) \cosh(h\sqrt{\xi^2 + \delta_k/ct}) \sinh(h\xi)}{\pi ct Q(h^2\xi)^3} \\ &+ \frac{\eta h^2 \cosh(h\sqrt{\xi^2 + \delta_k/ct}) [\sinh(z\xi) \cosh(h\xi) - (z/h) \sinh(h\xi) \cosh(z\xi)]}{\pi ct Qh\xi^2} \\ &+ \frac{\phi'}{\pi\delta_k} \frac{(h\sqrt{\xi^2 + \delta_k/ct}) \cosh(h\xi) [\sinh(z\sqrt{\xi^2 + \delta_k/ct}) \sinh(h\xi) - \sinh(z\xi) \sinh(h\sqrt{\xi^2 + \delta_k/ct})]}{Qh\xi^2}. \end{aligned} \quad (7.162)$$

For the numerical calculations it is convenient to introduce dimensionless variables $u = h\xi$, $x' = x/h$, $z' = z/h$, $a' = a/h$ and $\tau = ct/h^2$. The integral (7.158) then becomes

$$\frac{wG}{hq} = \frac{2}{5} \int_0^{\infty} \sum_{k=0}^{M-1} \Re\left\{ \gamma_k \frac{b(\delta_k/t)}{ht} \right\} \frac{\sin(a'u)}{u} \cos(x'u) du, \quad (7.163)$$

where, with (7.162),

$$\begin{aligned} \frac{b(\delta_k/t)}{ht} &= \frac{\phi\eta \sinh(z'u) \cosh(\sqrt{u^2 + \delta_k/\tau}) \sinh(u)}{\pi\tau Qu^2} \\ &+ \frac{\eta \cosh(\sqrt{u^2 + \delta_k/\tau}) [\sinh(u) \cosh(u) - z' \sinh(u) \cosh(z'u)]}{\pi\tau Qu} \\ &+ \frac{\phi'}{\pi\delta_k} \frac{(\sqrt{u^2 + \delta_k/\tau}) \cosh(u) [\sinh(z'\sqrt{u^2 + \delta_k/\tau}) \sinh(u) - \sinh(z'u) \sinh(\sqrt{u^2 + \delta_k/\tau})]}{Qu}, \end{aligned} \quad (7.164)$$

and where Q is defined by equation (7.152).

It may be noted that a factor u has been transferred from the expression (7.164) to the integral (7.163), so that then the factor $\sin(a'u)/u$ is finite for $u = 0$, and the integral may be easier to calculate.

As before, when considering the calculation of the pore pressure, the numerical procedures to calculate the values of the functions given in equations (7.152) and (7.164) contain several factors $\cosh(u)$ and $\sinh(u)$, which will tend towards infinity if $u \rightarrow \infty$. The computations may therefore become inaccurate, which can perhaps be avoided by writing

$$\cosh(u) = e(1 + d), \quad \sinh(u) = e(1 - d), \quad (7.165)$$

where

$$e = \frac{1}{2} \exp(u), \quad d = \exp(-2d). \quad (7.166)$$

Contours of the vertical displacement, calculated by the program PSPL, are shown in Figures 7.20, 7.21 and 7.22 for three values of ct/h^2 . The maximum values of the parameter wG/hq in the three figures is 0.261150,

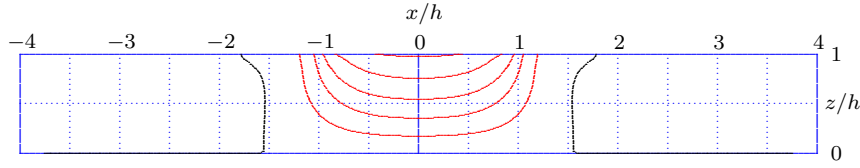

Figure 7.20: PSPL : Vertical displacement, $ct/h^2 = 0.001$.

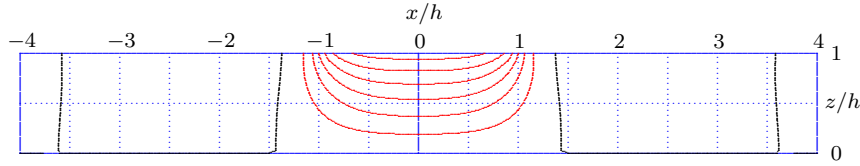

Figure 7.21: PSPL : Vertical displacement, $ct/h^2 = 0.1$.

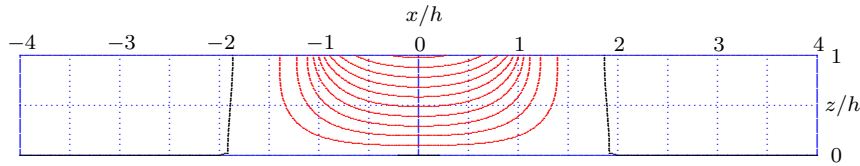

Figure 7.22: PSPL : Vertical displacement, $ct/h^2 = 10$.

0.328960 and 0.508750.

7.5 The vertical displacement of the surface

The vertical displacements of the surface $z = h$ are of special interest, of course. These are considered in this section.

The Laplace transform of the vertical displacement is given by the Laplace transform of equation (7.2),

$$\bar{u}_z = -\frac{\partial \bar{D}}{\partial z} + z \frac{\partial \bar{F}}{\partial z} + (1 - 2\phi)\bar{F}. \quad (7.167)$$

The three terms in this expression are given by equations (7.34), (7.43) and (7.32),

$$\frac{\partial \bar{D}}{\partial z} = \int_0^\infty \{C_1 \xi \sinh(z\xi) + C_2 \zeta \sinh(z\zeta)\} \cos(x\xi) d\xi, \quad (7.168)$$

$$\frac{\partial \bar{F}}{\partial z} = \int_0^\infty C_3 \xi \cosh(z\xi) \cos(x\xi) d\xi, \quad (7.169)$$

$$\bar{F} = \int_0^\infty C_3 \sinh(z\xi) \cos(x\xi) d\xi. \quad (7.170)$$

The three constants C_1 , C_2 and C_3 are given by equations (7.56), (7.53) and (7.57),

$$C_1 = \frac{q}{\pi G s \xi^3} \frac{R}{Q} \sin(a\xi), \quad (7.171)$$

$$C_2 = \frac{q}{\pi G s \xi^3} \frac{\phi'(h\xi) \sinh(h\xi) \cosh(h\xi)}{Q} \sin(a\xi), \quad (7.172)$$

$$C_3 h = \frac{q}{\pi G s \xi^3} \frac{\eta(h\lambda)^2 \sinh(h\xi) \cosh(h\xi)}{Q} \sin(a\xi), \quad (7.173)$$

where the expressions Q and R are defined in equations (7.55) and (7.47),

$$Q = \eta(h\lambda)^2 \cosh(h\zeta) \{1 + \sinh(h\xi) \cosh(h\xi)/(h\xi)\} + \phi' \cosh(h\xi) \{ (h\xi) \sinh(h\xi) \cosh(h\zeta) - (h\zeta) \sinh(h\zeta) \cosh(h\xi) \}, \quad (7.174)$$

$$R = \eta(h\lambda)^2 \cosh(h\zeta) \{ (1 - \phi) \sinh(h\xi)/(h\xi) + \cosh(h\xi) \} - \phi' (h\zeta) \sinh(h\zeta) \cosh(h\xi). \quad (7.175)$$

The vertical displacement of the surface $z = h$ is now denoted by $-w$, the minus sign indicating that the displacement is expected to be in negative z -direction. It follows from equation (7.167) that this is

$$\frac{\bar{w}G}{hq} = \int_0^\infty \left\{ \frac{f_1 + f_2 + f_3 + f_4}{\pi s Q} \right\} \frac{\sinh(h\xi)}{h\xi} \frac{\sin(a\xi)}{\xi} \cos(x\xi) d\xi, \quad (7.176)$$

where

$$f_1 = R, \quad (7.177)$$

$$f_2 = \phi' (h\zeta) \sinh(h\zeta) \cosh(h\xi), \quad (7.178)$$

$$f_3 = -\eta(h\lambda)^2 \cosh(h\xi) \cosh(h\zeta), \quad (7.179)$$

$$f_4 = -(1 - 2\phi)\eta(h\lambda)^2 \cosh(h\zeta) \sinh(h\xi)/(h\xi). \quad (7.180)$$

It follows that

$$f_1 + f_2 = \eta(h\lambda)^2 \cosh(h\zeta) \{ (1 - \phi) \sinh(h\xi)/(h\xi) + \cosh(h\xi) \}, \quad (7.181)$$

$$f_1 + f_2 + f_3 = (1 - \phi)\eta(h\lambda)^2 \cosh(h\zeta) \frac{\sinh(h\xi)}{h\xi}, \quad (7.182)$$

$$f_1 + f_2 + f_3 + f_4 = \phi\eta(h\lambda)^2 \cosh(h\zeta) \frac{\sinh(h\xi)}{h\xi}. \quad (7.183)$$

Equation (7.176) can now be written as

$$\frac{\bar{w}G}{hq} = \int_0^\infty b(s) \frac{\sin(as)}{s} \cos(xs) ds, \quad (7.184)$$

where

$$b(s) = \frac{\phi\eta h^2 \cosh(h\zeta) \sinh^2(h\xi)}{\pi c Q(h\xi)^2}. \quad (7.185)$$

It may be noted that equation (7.185) can also be obtained by taking the limiting value of equation (7.156) for $z = h$.

The function $b(s)$ is the Laplace transform of a function $B(t)$,

$$b(s) = \int_0^\infty B(t) \exp(-st) dt. \quad (7.186)$$

The inverse Laplace transform of equation (7.184) is

$$\frac{wG}{hq} = \int_0^\infty B(t) \frac{\sin(at)}{t} \cos(xt) dt. \quad (7.187)$$

The Talbot algorithm for the calculation of the inverse Laplace transform $B(t)$ is

$$B(t) = \frac{2}{5} \sum_{k=0}^{M-1} \Re \left\{ \gamma_k \frac{b(\delta_k/t)}{t} \right\}, \quad (7.188)$$

where M is an integer indicating the number of terms in the approximation (e.g. $M = 10$ or $M = 20$), and where

$$\delta_0 = \frac{2M}{5}, \quad \delta_k = \frac{2k\pi}{5} [\cot(k\pi/M) + i], \quad 0 < k < M, \quad (7.189)$$

$$\gamma_0 = \frac{\exp(\delta_0)}{2}, \quad \gamma_k = \left\{ 1 + i(k\pi/M)(1 + [\cot(k\pi/M)]^2) - i \cot(k\pi/M) \right\} \exp(\delta_k), \quad 0 < k < M. \quad (7.190)$$

In the problem considered here

$$\frac{b(\delta_k/t)}{t} = \frac{\phi\eta h^2 \cosh(h\sqrt{\xi^2 + \delta_k/ct}) \sinh^2(h\xi)}{\pi ct Q(h\xi)^2}. \quad (7.191)$$

For the numerical calculations it is convenient to introduce dimensionless variables $u = h\xi$, $x' = x/h$, $a' = a/h$ and $\tau = ct/h^2$. The integral (7.187) then becomes

$$\frac{wG}{hq} = \frac{2}{5} \int_0^\infty \sum_{k=0}^{M-1} \Re\left\{ \gamma_k \frac{b(\delta_k/t)}{ht} \right\} \frac{\sin(a'u)}{u} \cos(x'u) du, \quad (7.192)$$

where, with (7.191),

$$\frac{b(\delta_k/t)}{ht} = \frac{\phi\eta \cosh(\sqrt{u^2 + \delta_k/\tau}) \sinh^2(u)}{\pi\tau Qu^2}, \quad (7.193)$$

and where Q is defined by equation (7.174).

As before, when considering the calculation of the pore pressure, the numerical procedures to calculate the values of the function given in equation (7.193) contain several factors $\cosh(u)$ and $\sinh(u)$, which will tend towards infinity if $u \rightarrow \infty$. The computations may therefore become inaccurate, which can perhaps be avoided by writing

$$\cosh(u) = e(1 + d), \quad \sinh(u) = e(1 - d), \quad (7.194)$$

where

$$e = \frac{1}{2} \exp(u), \quad d = \exp(-2d). \quad (7.195)$$

Equation (7.193) can now be written as

$$\frac{b(\delta_k/t)}{ht} = \frac{\phi\eta \cosh(\sqrt{u^2 + \delta_k/\tau})(1 - d)^2}{\pi\tau Q'u^2}, \quad (7.196)$$

where $Q' = Qe^2$, or

$$Q' = \eta(\delta_k/\tau) \cosh(\sqrt{u^2 + \delta_k/\tau}) \{ e^{-2} + (1 - d^2)/u \} + \phi'(1 + d) \{ u(1 - d) \cosh(\sqrt{u^2 + \delta_k/\tau}) - (\sqrt{u^2 + \delta_k/\tau}) \sinh(\sqrt{u^2 + \delta_k/\tau})(1 + d) \}. \quad (7.197)$$

The vertical displacement of the center of the loaded surface ($x = 0$) is shown, as a function of ct/h^2 in Figure 7.23, for the case that $\nu = 0$, $\alpha = 1$, $S = 0$ and $a/h = 1$. The final value of the displacement

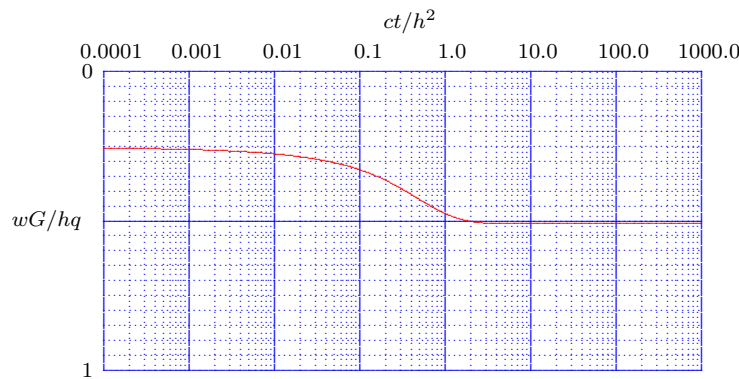

Figure 7.23: PSPL : Surface displacement.

should be in agreement with the result of an elastic analysis of the problem (Filon's problem), as given by Sneddon (1951). This value is $wG/hq = 0.506$. The initial value of the displacement can be obtained from an undrained analysis, taking $\nu = 0.5$, which gives $wG/hq = 0.253$. These values are in good agreement with the data shown in Figure 7.23. The results are also in good agreement with the results obtained, using an analytical solution, by Gibson, Schiffman & Pu (1970).

7.6 Concluding remarks

It may be observed, by running the program PSPL for various values of Poisson's ratio ν , that the total stresses σ_{zz} , σ_{xx} and σ_{xz} are practically independent of this value, a fact that is also true for the elastic solution (Filon's problem). This can be understood by noting that in all these problems the boundary conditions at the upper and lower boundary express that the shear stress vanishes. Thus, there is no way of generating significant horizontal stresses or shear stresses from the boundaries. As an alternative to the problem considered in this chapter, the problem of a strip load on a poroelastic layer on a fully fixed horizontal bottom, with both displacement components being zero, may be considered. It can be expected that the horizontal stresses in that case are much larger, especially for large values of Poisson's ratio. This has indeed been found by Christian, Boehmer & Martin (1972), using a numerical solution.

AXIALLY SYMMETRIC HALF SPACE PROBLEMS

8.1 Introduction

This chapter presents the solution of problems of axially symmetric consolidation of a poroelastic half space, with a given normal load on the surface. As for the plane strain problems considered in chapter 6, the solution method uses the displacement functions introduced by McNamee & Gibson (1960), with the functions being generalized to take into account the compressibility of the pore fluid and the solid particles.

As an example the solution for a uniform load over a circular area will be considered. Some initial results for this problem were given by McNamee & Gibson (1960), for the surface displacements in case of incompressible constituents. Additional results were announced in this paper, but were never published. In this chapter the solution is extended to a more general porous medium, with compressible constituents, and solutions are given for the vertical displacements of the surface, and the pore pressure and the stress components throughout the half space.

As in the original paper by McNamee & Gibson (1960) the problem is solved using Laplace and Hankel transformations. It appears that the inverse Laplace transform can be obtained in closed form for certain quantities, but for the components of total stress a numerical inversion method is needed. The inverse Hankel transforms are also determined numerically.

Notations and sign conventions are as defined in Chapter 1. This means that compressive stresses are considered positive.

8.2 Axially symmetric deformations

8.2.1 Basic equations

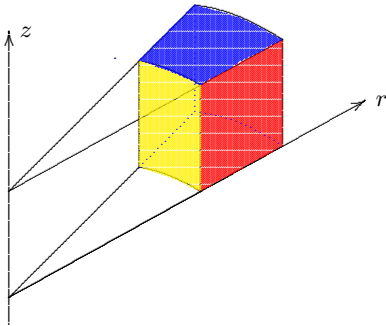

Figure 8.1: Axially symmetric element.

The basic equations of axially symmetric consolidation of a homogeneous elastic porous medium are the storage equation and the equations of equilibrium in the two coordinate directions r and z , see Figure 8.1. In the case of axially symmetric deformations the storage equation (1.36) is, allowing for a linearly compressible fluid and linearly compressible solid particles,

$$\alpha \frac{\partial \varepsilon}{\partial t} + S \frac{\partial p}{\partial t} = \frac{k}{\gamma_f} \left(\frac{\partial^2 p}{\partial r^2} + \frac{1}{r} \frac{\partial p}{\partial r} + \frac{\partial^2 p}{\partial z^2} \right), \quad (8.1)$$

where k is the permeability of the porous material, γ_f is the volumetric weight of the fluid, p is the pore pressure, and α is the Biot coefficient,

$$\alpha = 1 - C_s/C_m, \quad (8.2)$$

where C_s is the compressibility of the particle material, and C_m is the compressibility of the porous medium as a whole, the inverse of its compression modulus, $C_m = 1/K$. Finally, the parameter S is the storativity, defined as

$$S = nC_f + (\alpha - n)C_s, \quad (8.3)$$

where C_f is the compressibility of the pore fluid and C_s is the compressibility of the particle material.

As mentioned before, in the classical theory, applicable for very soft soils, the compressibilities C_f and C_s are assumed to be so small compared to the compressibility of the soil C_m that they can be disregarded, $C_f = C_s = 0$. In that case $\alpha = 1$ and $S = 0$.

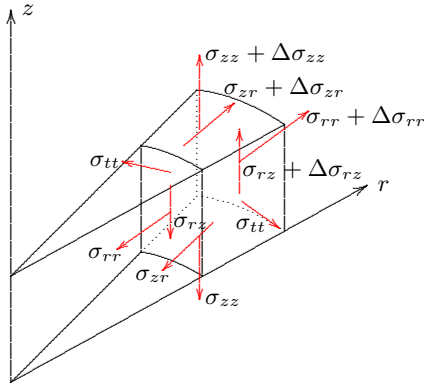

Figure 8.2: Equilibrium of element.

The two equations of equilibrium are, in terms of the total stresses,

$$\frac{\partial \sigma_{rr}}{\partial r} + \frac{\sigma_{rr} - \sigma_{tt}}{r} + \frac{\partial \sigma_{zr}}{\partial z} = 0, \quad (8.4)$$

$$\frac{\partial \sigma_{zz}}{\partial z} + \frac{\partial \sigma_{rz}}{\partial r} + \frac{\sigma_{rz}}{r} = 0. \quad (8.5)$$

The total stresses can be decomposed into the effective stresses and the pore pressure by Terzaghi's relations,

$$\sigma_{rr} = \sigma'_{rr} + \alpha p, \quad \sigma_{rz} = \sigma'_{rz}, \quad (8.6)$$

$$\sigma_{zz} = \sigma'_{zz} + \alpha p, \quad \sigma_{zr} = \sigma'_{zr}, \quad (8.7)$$

The effective stresses can be expressed into the displacement components u_r and u_z by Hooke's law for the case of axial symmetry,

$$\sigma'_{rr} = -(K - \frac{2}{3}G)\varepsilon - 2G\frac{\partial u_r}{\partial r}, \quad (8.8)$$

$$\sigma'_{tt} = -(K - \frac{2}{3}G)\varepsilon - 2G\frac{u_r}{r}, \quad (8.9)$$

$$\sigma'_{zz} = -(K - \frac{2}{3}G)\varepsilon - 2G\frac{\partial u_z}{\partial z}, \quad (8.10)$$

$$\sigma'_{rz} = \sigma'_{zr} = -G\left(\frac{\partial u_r}{\partial z} + \frac{\partial u_z}{\partial r}\right), \quad (8.11)$$

$$\sigma'_{rt} = \sigma'_{tr} = 0, \quad (8.12)$$

$$\sigma'_{zt} = \sigma'_{tz} = 0. \quad (8.13)$$

where K and G are the compression modulus and the shear modulus of the porous medium, the displacement components in the directions of the coordinates r and z are denoted as u_r and u_z , and the volume strain is

$$\varepsilon = \frac{\partial u_r}{\partial r} + \frac{u_r}{r} + \frac{\partial u_z}{\partial z}. \quad (8.14)$$

The sign convention for the stresses is that compressive stresses are considered positive (as for the pore pressure), which is standard practice in soil mechanics. For this reason the expressions for Hooke's law, equations (8.8) – (8.11) contain a minus sign.

The equations of equilibrium can be expressed in terms of the displacements and the pore pressure as

$$\left(K + \frac{1}{3}G\right)\frac{\partial \varepsilon}{\partial r} + G\left(\nabla^2 u_r - \frac{u_r}{r^2}\right) - \alpha\frac{\partial p}{\partial r} = 0, \quad (8.15)$$

$$\left(K + \frac{1}{3}G\right)\frac{\partial \varepsilon}{\partial z} + G\nabla^2 u_z - \alpha\frac{\partial p}{\partial z} = 0, \quad (8.16)$$

or, in a more convenient form, suggested by McNamee & Gibson (1960),

$$(2\eta - 1)G\frac{\partial \varepsilon}{\partial r} + G\left(\nabla^2 u_r - \frac{u_r}{r^2}\right) - \alpha\frac{\partial p}{\partial r} = 0, \quad (8.17)$$

$$(2\eta - 1)G\frac{\partial \varepsilon}{\partial z} + G\nabla^2 u_z - \alpha\frac{\partial p}{\partial z} = 0, \quad (8.18)$$

where in this case of axial symmetry

$$\nabla^2 = \frac{\partial^2}{\partial r^2} + \frac{1}{r}\frac{\partial}{\partial r} + \frac{\partial^2}{\partial z^2}, \quad (8.19)$$

and where, as before, see equation (6.16),

$$\eta = \frac{1 - \nu}{1 - 2\nu} = \frac{K + \frac{4}{3}G}{2G}. \quad (8.20)$$

Again it will appear to be mathematically most convenient to express the elastic constants by the shear modulus G and the dimensionless coefficient η , rather than another combination of elastic coefficients, such as E and ν or K and G .

8.2.2 Displacement functions

It can be derived, by differentiating equation (8.17) with respect to r , multiplying equation (8.17) by $1/r$, differentiating equation (8.18) with respect to z , and then adding the three resulting equations, that

$$\nabla^2(2\eta G\varepsilon - \alpha p) = 0. \quad (8.21)$$

It follows that one may write

$$\frac{\alpha p}{2G} = \eta\varepsilon + \phi \frac{\partial F}{\partial z}, \quad (8.22)$$

where ϕ is a constant that will be specified later, and F is any harmonic function,

$$\nabla^2 F = 0. \quad (8.23)$$

Furthermore, it is assumed that the two equilibrium equations can be satisfied by writing

$$u_r = -\frac{\partial D}{\partial r} + z \frac{\partial F}{\partial r}, \quad (8.24)$$

$$u_z = -\frac{\partial D}{\partial z} + z \frac{\partial F}{\partial z} + (1 - 2\phi)F, \quad (8.25)$$

where ϕ is the same constant as introduced in equation (8.22), but still unknown.

The volume strain ε now is

$$\varepsilon = -\nabla^2 D + 2(1 - \phi) \frac{\partial F}{\partial z}. \quad (8.26)$$

With equation (8.22) it now follows that the pore pressure can be expressed into the displacement functions D and F by the relation

$$\frac{\alpha p}{2G} = -\eta \nabla^2 D + \phi' \frac{\partial F}{\partial z}, \quad (8.27)$$

where

$$\phi' = \phi + 2\eta(1 - \phi). \quad (8.28)$$

It can easily be verified that the equilibrium equations (8.17) and (8.18) are identically satisfied, provided that the function F is indeed harmonic, as specified in equation (8.23). The constant ϕ remains undetermined at this stage.

The differential equation for the displacement function D can be obtained by substitution of equations (8.26) and (8.27) into the storage equation (8.1). In this process the coefficient ϕ is now chosen such that the coefficient of the term $\partial^2 F / \partial t \partial z$ vanishes, so that the differential equation for D remains as simple as possible. This leads to the same condition for ϕ as in the previous chapter, see equation (6.25),

$$\phi = \frac{\alpha^2 + S(K + \frac{4}{3}G)}{\alpha^2 + S(K + \frac{1}{3}G)}. \quad (8.29)$$

The final differential equation for the function D is

$$\frac{\partial}{\partial t} \nabla^2 D = c \nabla^2 \nabla^2 D, \quad (8.30)$$

where the consolidation coefficient c is defined as

$$c = \frac{k(K + \frac{4}{3}G)}{[\alpha^2 + S(K + \frac{4}{3}G)]\gamma_f}. \quad (8.31)$$

The expressions for the total stresses are now found to be

$$\frac{\sigma_{rr}}{2G} = \varepsilon - \frac{\partial u_r}{\partial r} + \phi \frac{\partial F}{\partial z} = -\nabla^2 D + \frac{\partial^2 D}{\partial r^2} - z \frac{\partial^2 F}{\partial r^2} + (2 - \phi) \frac{\partial F}{\partial z}, \quad (8.32)$$

$$\frac{\sigma_{tt}}{2G} = \varepsilon - \frac{u_r}{r} + \phi \frac{\partial F}{\partial z} = -\nabla^2 D + \frac{1}{r} \frac{\partial D}{\partial r} - \frac{z}{r} \frac{\partial F}{\partial r} + (2 - \phi) \frac{\partial F}{\partial z}, \quad (8.33)$$

$$\frac{\sigma_{zz}}{2G} = \varepsilon - \frac{\partial u_z}{\partial z} + \phi \frac{\partial F}{\partial z} = -\nabla^2 D + \frac{\partial^2 D}{\partial z^2} - z \frac{\partial^2 F}{\partial z^2} + \phi \frac{\partial F}{\partial z}, \quad (8.34)$$

$$\frac{\sigma_{rz}}{2G} = -\frac{1}{2} \frac{\partial u_r}{\partial z} - \frac{1}{2} \frac{\partial u_z}{\partial r} = \frac{\partial^2 D}{\partial r \partial z} - z \frac{\partial^2 F}{\partial r \partial z} - (1 - \phi) \frac{\partial F}{\partial r}. \quad (8.35)$$

The isotropic total stress is

$$\frac{\sigma_0}{2G} = -\frac{2}{3} \nabla^2 D + \frac{1}{3} (4 - \phi) \frac{\partial F}{\partial z}. \quad (8.36)$$

For the case $\alpha = 1$ and $C = 0$ (i.e. incompressible fluid and incompressible particles) it follows that $\phi = 1$. The equations then reduce to the equations first given in the paper by McNamee & Gibson (1960).

8.3 Disk load on half space

In this section some problems of axially symmetric deformation of the half space $z \geq 0$ will be considered. The boundary conditions are supposed to be that the surface $z = 0$ is fully drained ($p = 0$) and free of shear stress ($\sigma_{zr} = 0$), and loaded by a given distribution of normal stresses σ_{zz} , see Figure 8.3. It is assumed that these

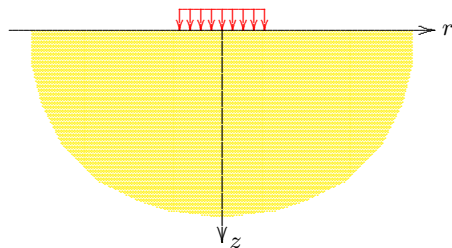

boundary conditions can be expressed by the Laplace transforms

$$z = 0 : \bar{p} = 0, \quad (8.37)$$

$$z = 0 : \bar{\sigma}_{zr} = 0, \quad (8.38)$$

$$z = 0 : \bar{\sigma}_{zz} = 2G g(r), \quad (8.39)$$

Figure 8.3: Uniform load on circular area. This will be denoted as a *disk load*.

where $g(r)$ is a given function of the radial coordinate, in particular a function describing a uniform load over a circular area of radius a .

8.3.1 General solution

For the half space $z \geq 0$ with axial symmetry the general solution of the differential equations (8.23) and (8.30) can be written as the Laplace transforms

$$\bar{D} = \int_0^\infty \{A_1 \exp(-z\xi) + A_2 \exp(-z\sqrt{\xi^2 + \lambda^2})\} J_0(r\xi) d\xi, \quad (8.40)$$

$$\bar{F} = \int_0^\infty B_1 \exp(-z\xi) J_0(r\xi) d\xi, \quad (8.41)$$

where

$$\lambda^2 = s/c. \quad (8.42)$$

The solutions (8.40) and (8.41) have been obtained by omitting the terms that are unbounded at infinity (for $z \rightarrow \infty$).

From these two solutions the following derivatives can be derived

$$\frac{1}{r} \frac{\partial \bar{D}}{\partial r} = - \int_0^\infty \{A_1 \xi^2 \exp(-z\xi) + A_2 \xi^2 \exp(-z\sqrt{\xi^2 + \lambda^2})\} \frac{J_1(r\xi)}{\xi r} d\xi, \quad (8.43)$$

$$\frac{\partial^2 \bar{D}}{\partial r^2} = - \int_0^\infty \{A_1 \xi^2 \exp(-z\xi) + A_2 \xi^2 \exp(-z\sqrt{\xi^2 + \lambda^2})\} \left\{ J_0(r\xi) - \frac{J_1(r\xi)}{r\xi} \right\} d\xi, \quad (8.44)$$

$$\frac{\partial^2 \bar{D}}{\partial z^2} = \int_0^\infty \{A_1 \xi^2 \exp(-z\xi) + A_2 (\xi^2 + \lambda^2) \exp(-z\sqrt{\xi^2 + \lambda^2})\} J_0(r\xi) d\xi, \quad (8.45)$$

$$\nabla^2 \bar{D} = \int_0^\infty \{A_2 \lambda^2 \exp(-z\sqrt{\xi^2 + \lambda^2})\} J_0(r\xi) d\xi, \quad (8.46)$$

$$\frac{\partial^2 \bar{D}}{\partial r \partial z} = \int_0^\infty \{A_1 \xi^2 \exp(-z\xi) + A_2 \xi \sqrt{\xi^2 + \lambda^2} \exp(-z\sqrt{\xi^2 + \lambda^2})\} J_1(r\xi) d\xi, \quad (8.47)$$

$$\frac{\partial \bar{F}}{\partial r} = \int_0^\infty -B_1 \xi \exp(-z\xi) J_1(r\xi) d\xi, \quad (8.48)$$

$$\frac{\partial^2 \bar{F}}{\partial r \partial z} = \int_0^\infty B_1 \xi^2 \exp(-z\xi) J_1(r\xi) d\xi, \quad (8.49)$$

$$\frac{\partial \bar{F}}{\partial z} = \int_0^\infty -B_1 \xi \exp(-z\xi) J_0(r\xi) d\xi, \quad (8.50)$$

$$\frac{\partial^2 \bar{F}}{\partial z^2} = \int_0^\infty B_1 \xi^2 \exp(-z\xi) J_0(r\xi) d\xi. \quad (8.51)$$

The boundary conditions will next be used to determine the three constants A_1 , A_2 and B_1 .

It follows from the Laplace transform of equation (8.27) that

$$\frac{\alpha \bar{p}}{2G} = - \int_0^\infty \{A_2 \eta \lambda^2 \exp(-z\sqrt{\xi^2 + \lambda^2}) + B_1 \phi' \xi \exp(-z\xi)\} J_0(r\xi) d\xi. \quad (8.52)$$

The first boundary condition, equation (8.37), now gives

$$A_2 \eta \lambda^2 + B_1 \phi' \xi = 0. \quad (8.53)$$

Furthermore, it follows from the Laplace transform of equation (8.35) that

$$\begin{aligned} \frac{\bar{\sigma}_{zr}}{2G} = \int_0^\infty \{ & A_1 \xi^2 \exp(-z\xi) + A_2 \xi \sqrt{\xi^2 + \lambda^2} \exp(-z\sqrt{\xi^2 + \lambda^2}) + \\ & B_1 \xi (1 - \phi - z\xi) \exp(-z\xi) \} J_1(r\xi) d\xi. \end{aligned} \quad (8.54)$$

The second boundary condition, equation (8.38), now gives

$$A_1 \xi^2 + A_2 \xi \sqrt{\xi^2 + \lambda^2} + B_1 \xi (1 - \phi) = 0. \quad (8.55)$$

Finally, it follows from the Laplace transform of equation (8.34) that

$$\frac{\bar{\sigma}_{zz}}{2G} = \int_0^\infty \{A_1 \xi^2 \exp(-z\xi) + A_2 \xi^2 \exp(-z\sqrt{\xi^2 + \lambda^2}) - B_1 \xi (\phi + z\xi) \exp(-z\xi)\} J_0(r\xi) d\xi. \quad (8.56)$$

The third boundary condition, equation (8.39), now gives

$$\int_0^\infty \{A_1 \xi^2 + A_2 \xi^2 - B_1 \phi \xi\} J_0(r\xi) d\xi = g(r). \quad (8.57)$$

It follows from equation (8.53) that

$$B_1 \xi = -A_2 \eta \lambda^2 / \phi'. \quad (8.58)$$

And then it follows from equation (8.55) that

$$A_1 \xi^2 = -A_2 (\xi \sqrt{\xi^2 + \lambda^2} - \eta \lambda^2 (1 - \phi) / \phi'). \quad (8.59)$$

Using equations (8.58) and (8.59) it follows that equation (8.57) can be written as

$$\int_0^\infty A_2 \{ \xi^2 + \eta \lambda^2 / \phi' - \xi \sqrt{\xi^2 + \lambda^2} \} J_0(r\xi) d\xi = g(r). \quad (8.60)$$

The integral equation (8.60) is in the form of a Hankel transform. Its inverse gives

$$A_2 = \frac{\xi}{\xi^2 + \eta \lambda^2 / \phi' - \xi \sqrt{\xi^2 + \lambda^2}} \int_0^\infty r g(r) J_0(\xi r) dr. \quad (8.61)$$

The two other constants, A_1 and B_1 , can now be determined from the equations (8.59) and (8.58),

$$A_1 = -\frac{\xi\sqrt{\xi^2 + \lambda^2} - \eta\lambda^2(1 - \phi)/\phi'}{\xi(\xi^2 + \eta\lambda^2/\phi' - \xi\sqrt{\xi^2 + \lambda^2})} \int_0^\infty rg(r)J_0(\xi r) dr, \quad (8.62)$$

$$B_1 = -\frac{\eta\lambda^2/\phi'}{\xi^2 + \eta\lambda^2/\phi' - \xi\sqrt{\xi^2 + \lambda^2}} \int_0^\infty rg(r)J_0(\xi r) dr. \quad (8.63)$$

This completes the general solution of the problem.

8.3.2 The other stresses

For future reference it is convenient to give here the expressions for the Laplace transforms of the radial total stress and the tangential total stress.

It follows from the Laplace transform of equation (8.32) that

$$\frac{\bar{\sigma}_{rr}}{2G} = -\nabla^2 \bar{D} + \frac{\partial^2 \bar{D}}{\partial r^2} - z \frac{\partial^2 \bar{F}}{\partial r^2} + (2 - \phi) \frac{\partial \bar{F}}{\partial z}. \quad (8.64)$$

Using the expressions for the displacement functions and their derivatives, equations (8.40) – (8.51), this now gives

$$\begin{aligned} \frac{\bar{\sigma}_{rr}}{2G} = & -\int_0^\infty \{[A_1\xi^2 + B_1\xi(2 - \phi - z\xi)] \exp(-z\xi) + A_2(\xi^2 + \lambda^2) \exp(-z\sqrt{\xi^2 + \lambda^2})\} J_0(r\xi) d\xi \\ & + \int_0^\infty \{(A_1\xi - B_1z\xi)\xi \exp(-z\xi) + A_2\xi^2 \exp(-z\sqrt{\xi^2 + \lambda^2})\} \frac{J_1(r\xi)}{r\xi} d\xi. \end{aligned} \quad (8.65)$$

The Laplace transform of equation (8.33) is

$$\frac{\bar{\sigma}_{tt}}{2G} = -\nabla^2 \bar{D} + \frac{1}{r} \frac{\partial \bar{D}}{\partial r} - \frac{z}{r} \frac{\partial \bar{F}}{\partial r} + (2 - \phi) \frac{\partial \bar{F}}{\partial z}. \quad (8.66)$$

Using the equations (8.40) – (8.51) this now gives

$$\begin{aligned} \frac{\bar{\sigma}_{tt}}{2G} = & -\int_0^\infty \{(2 - \phi)B_1\xi \exp(-z\xi) + A_2\lambda^2 \exp(-z\sqrt{\xi^2 + \lambda^2})\} J_0(r\xi) d\xi \\ & - \int_0^\infty \{(A_1\xi - B_1z\xi)\xi \exp(-z\xi) + A_2\xi^2 \exp(-z\sqrt{\xi^2 + \lambda^2})\} \frac{J_1(r\xi)}{r\xi} d\xi. \end{aligned} \quad (8.67)$$

It follows from addition of equations (8.56), (8.65) and (8.67) that

$$\frac{\bar{\sigma}_0}{2G} = -\frac{1}{3} \int_0^\infty \{2A_2\lambda^2 \exp(-z\sqrt{\xi^2 + \lambda^2}) + (4 - \phi)B_1\xi \exp(-z\xi)\} J_0(r\xi) d\xi. \quad (8.68)$$

This result can also be derived from equation (8.36).

8.3.3 Results for a disk load

For the case of a uniform load q over a circular region of radius a , applied at time $t = 0$, a disk load, the boundary condition for the vertical normal stress is

$$z = 0 : \frac{\sigma_{zz}}{2G} = \begin{cases} q/2G, & r < a, \\ 0, & r > a. \end{cases} \quad (8.69)$$

The Laplace transform of this condition is

$$z = 0 : \frac{\bar{\sigma}_{zz}}{2G} = g(r) = \begin{cases} q/2Gs, & r < a, \\ 0, & r > a. \end{cases} \quad (8.70)$$

The representation of this function by a Hankel integral is

$$\int_0^\infty rg(r)J_0(\xi r)dr = \frac{qa}{2Gs\xi}J_1(\xi a). \quad (8.71)$$

Substitution into equation (8.61) gives

$$A_2 = \frac{qa}{2Gs} \frac{1}{\xi^2 + \eta\lambda^2/\phi' - \xi\sqrt{\xi^2 + \lambda^2}} J_1(\xi a). \quad (8.72)$$

Using equations (8.59) and (8.58) the other two constants are found to be

$$B_1 = -\frac{qa}{2Gs} \frac{\eta\lambda^2/\phi'\xi}{\xi^2 + \eta\lambda^2/\phi' - \xi\sqrt{\xi^2 + \lambda^2}} J_1(\xi a), \quad (8.73)$$

$$A_1 = -\frac{qa}{2Gs} \frac{\sqrt{\xi^2 + \lambda^2}/\xi - \eta\lambda^2(1-\phi)/\phi'\xi^2}{\xi^2 + \eta\lambda^2/\phi' - \xi\sqrt{\xi^2 + \lambda^2}} J_1(\xi a). \quad (8.74)$$

8.3.4 Vertical displacement of the surface

One of the most interesting quantities to be elaborated is the vertical displacement w of the surface $z = 0$. It follows from equation (8.25) that this can be written as

$$\bar{w} = -\frac{\partial \bar{D}}{\partial z} + (1-2\phi)\bar{F} = \int_0^\infty \{A_1\xi + A_2\sqrt{\xi^2 + \lambda^2} + (1-2\phi)B_1\}J_0(r\xi)d\xi. \quad (8.75)$$

Using the expressions (8.72), (8.73), (8.74) and the equality $\lambda^2 = s/c$ this gives

$$\bar{w} = \frac{qa\eta\phi}{2Gc\phi'} \int_0^\infty \frac{1/\xi}{\xi^2 + \eta\lambda^2/\phi' - \xi\sqrt{\xi^2 + \lambda^2}} J_1(\xi a)J_0(\xi r)d\xi. \quad (8.76)$$

Limit for large values of time

For large values of time it can be expected that the pore pressures have vanished, so that the displacements should be in agreement with the well known results for this problem from the classical theory of elasticity. In order to verify this property a theorem from Laplace transform theory may be used, that states that the limiting value of the vertical displacement of the surface $z = 0$ for large values of time can be obtained using the property (Churchill, 1972)

$$w_\infty = \lim_{t \rightarrow \infty} w = \lim_{s \rightarrow 0} s\bar{w}. \quad (8.77)$$

Application of this theorem to equation (8.76) gives, using the definitions of η , ϕ and ϕ' ,

$$w_\infty = \frac{qa(1-\nu)}{G} \int_0^\infty \frac{1}{\xi} J_1(\xi a)J_0(\xi r)d\xi, \quad (8.78)$$

or, using a well known Hankel integral transform, see the equations (11.4.33) and (11.4.34) in Abramowitz & Stegun (1964),

$$w_\infty = \frac{2qa(1-\nu)}{\pi G} \begin{cases} E(r^2/a^2), & r < a, \\ (r/a) \{E(a^2/r^2) - (1 - a^2/r^2)K(a^2/r^2)\}, & r > a, \end{cases} \quad (8.79)$$

where $K(x)$ and $E(x)$ are complete elliptic integrals of the first and second kind, respectively. This result is in agreement with results from the theory of elasticity, see e.g. Timoshenko & Goodier (1970).

The maximum displacement w_m occurs at the center $r = 0$. Because $E(0) = \pi/2$ it follows that this maximum is

$$w_m = \frac{qa(1-\nu)}{G}. \quad (8.80)$$

Limit for small values of time

Another useful theorem from Laplace transform theory (Churchill, 1972) is

$$\lim_{t \rightarrow 0} w = \lim_{s \rightarrow \infty} s\bar{w}. \quad (8.81)$$

Application of this theorem to equation (8.76) gives

$$w_0 = \frac{qa\phi}{2G} \int_0^\infty \frac{1}{\xi} J_1(\xi a) J_0(\xi r) d\xi. \quad (8.82)$$

Comparison with equation (8.78) shows that this expression is of the same form as the final displacement w_∞ , a property already noted by De Josselin de Jong (1957). Actually, in this case $w_0/w_\infty = \phi/2(1-\nu)$. It can be shown, using the definition of ϕ , that this factor is always smaller than 1, except when $K/G \rightarrow \infty$ (or $\nu = 0.5$), when it approaches 1. Thus, except when the soil is incompressible, the initial displacements are always smaller than the final displacements, as could be expected.

Displacements as a function of time

With equation (8.80) the expression for the Laplace transform of the vertical displacement, equation (8.76), can be written as

$$\frac{\bar{w}}{w_m} = \int_0^\infty f(s) \frac{J_1(\xi a)}{\xi} J_0(\xi r) d\xi, \quad (8.83)$$

where

$$f(s) = \frac{1}{2(1-\nu)} \frac{\eta\phi/\phi'}{c[\xi^2 + \eta\lambda^2/\phi' - \xi\sqrt{\xi^2 + \lambda^2}]}. \quad (8.84)$$

Because $\lambda^2 = s/c$ this function can be written as

$$f(s) = \frac{1}{2(1-\nu)} \frac{b\phi}{u^2 + bs - u\sqrt{s + u^2}}, \quad (8.85)$$

where $b = \eta/\phi'$ and $u^2 = c\xi^2$. It can be shown, from the definitions of η and ϕ' , that $b > 1$.

Using the definitions of the parameters b and ϕ the function $f(s)$ can also be written as

$$f(s) = \frac{1}{2u} \left\{ \frac{1}{\sqrt{s + u^2} - u} - \frac{1}{\sqrt{s + u^2} + du} \right\}, \quad (8.86)$$

where $d = (b-1)/b = 1 - 1/b$, with $0 < d < 1$, because $b > 1$.

The inverse Laplace transform of the two terms in this expression can be found using equation (37) from the table of standard Laplace transforms by Churchill (1972). This gives

$$F(\xi, t) = \frac{1}{2} \left\{ 1 + \operatorname{erf}(\sqrt{c\xi^2 t}) + d \exp[-(1-d^2)c\xi^2 t] \operatorname{erfc}(\sqrt{d^2 c\xi^2 t}) \right\}, \quad (8.87)$$

where the parameter u^2 has been replaced by its original value $u^2 = c\xi^2$.

It now follows that the inverse Laplace transformation of the expression (8.83) is

$$\frac{w}{w_m} = \int_0^\infty F(\xi, t) \frac{J_1(\xi a)}{\xi} J_0(\xi r) d\xi, \quad (8.88)$$

where the function $F(\xi, t)$ is given by equation (8.87), and w_m is the maximum vertical displacement, for $r = 0$ and $t \rightarrow \infty$, see equation (8.80). It seems unlikely that the Hankel integral transform (8.88) can be evaluated in closed form for arbitrary values of r and t . Therefore a numerical integration scheme will be used.

For $t \rightarrow \infty$ and $t \rightarrow 0$ the limiting values of $F(\xi, t)$ are constants, independent of ξ , and then the integrals can be evaluated in closed form. It follows from inspection of equation (8.87) that these limiting values are

$$\lim_{t \rightarrow \infty} F(\xi, t) = 1, \quad \lim_{t \rightarrow 0} F(\xi, t) = (1+d)/2 = \phi/2(1-\nu). \quad (8.89)$$

These values are in agreement with the results obtained in equations (8.78) and (8.82). It appears that the function $F(\xi, t)$ varies from $\phi/2(1-\nu)$ to 1, as time progresses from $t = 0$ to $t \rightarrow \infty$. If $\nu = 0$ and the particles and the fluid are incompressible (so that $\phi = 1$), the immediate response at time $t = 0$ is just one half of the ultimate response at $t \rightarrow \infty$, a result already obtained by De Josselin de Jong (1957).

Numerical analysis

For a numerical evaluation of the integral in equation (8.88) it is most convenient to introduce dimensionless parameters

$$x = a\xi, \quad \rho = r/a, \quad \tau = ct/a^2. \tag{8.90}$$

The integral then can be written as

$$\frac{w}{w_m} = \int_0^\infty F(x, \tau) \frac{J_1(x)}{x} J_0(x\rho) dx, \tag{8.91}$$

where

$$F(x, \tau) = \frac{1}{2} \left\{ 1 + \operatorname{erf}(\sqrt{x^2\tau}) + d \exp[-(1 - d^2)x^2\tau] [1 - \operatorname{erf}(\sqrt{d^2x^2\tau})] \right\}. \tag{8.92}$$

It may be noted that $x = 0$ is not a singularity of the integrand in equation (8.91), because the function $J_1(x)$ is of order $O(x)$ for $x \rightarrow 0$. A numerical integration of the integral (8.91) can be performed by limiting the upper bound of the integral by a sufficiently large value L , say $L = 500$, and then subdividing the integration range between $x = 0$ and $x = L$ into a large number N of intervals of equal length, and using Simpson's integration rule. It is suggested to take $N = 5000$, although a smaller number may also lead to acceptable results.

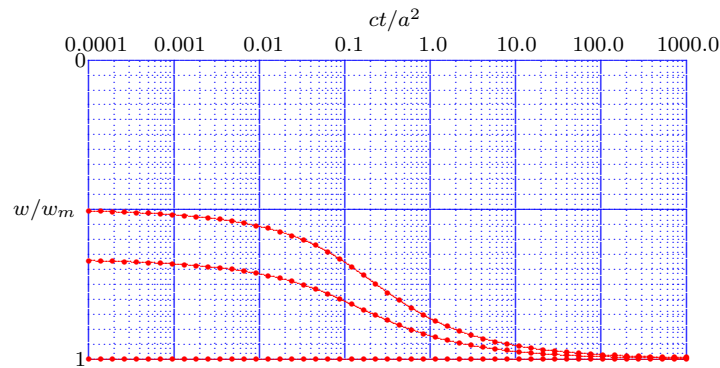

Figure 8.4: Vertical displacement of surface, $r/a = 0$, $\nu = 0, 0.25, 0.5$.

The results of a numerical integration are shown in Figure 8.4, for the case that $\alpha = 0$, $C = 0$, $r/a = 0$, and for three values of ν . The data confirm that for $t \rightarrow \infty$ the displacement approaches the maximum value w_m , and that for $\nu = 0$ and $t = 0$ the displacement is 50 % of that final value. The dots in the figure indicate the results obtained when using a numerical inversion of the Laplace transform, with Talbot's method, rather than the analytical Laplace inversion given above. It appears that these results can not be distinguished from the ones using the analytical inverse, equation (8.87), which provides support for the accuracy of the Talbot method.

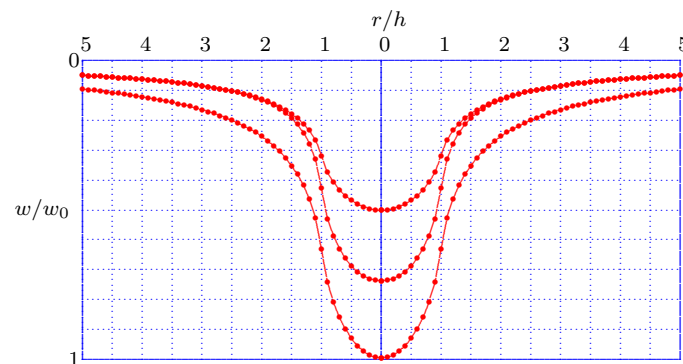

Figure 8.5: Vertical displacement of surface, $ct/a^2 = 0.000001, 0.2, 1000$.

Figure 8.5 shows the vertical displacements of the surface as a function of the radial coordinate r/a , for three values of time: $ct/a^2 = 0.000001$, $ct/a^2 = 0.2$ and $ct/a^2 = 1000$. Again, the dots in the figure indicate the results obtained when using a numerical inversion of the Laplace transform, using Talbot's method.

8.3.5 Pore pressure

The general expression for the Laplace transform of the pore pressure is, according to equation (8.52),

$$\frac{\alpha \bar{p}}{2G} = - \int_0^\infty \{A_2 \eta \lambda^2 \exp(-z \sqrt{\xi^2 + \lambda^2}) + B_1 \phi' \xi \exp(-z \xi)\} J_0(r \xi) d\xi. \quad (8.93)$$

Inserting the expressions (8.72) and (8.73) for the constants A_2 and B_1 gives

$$\frac{\bar{p}}{q} = \int_0^\infty g(s) J_1(\xi a) J_0(\xi r) d\xi, \quad (8.94)$$

where

$$g(s) = \int_0^\infty G(t) \exp(-st) dt = \frac{a\eta}{c\alpha} \frac{\exp(-z\xi) - \exp(-z\sqrt{\xi^2 + s/c})}{\xi^2 + bs/c - \xi\sqrt{\xi^2 + s/c}}, \quad (8.95)$$

where $b = \eta/\phi'$, and $\lambda^2 = s/c$, in agreement with the definition (8.42).

Because it seems unlikely that the integral (8.94) can be evaluated in closed form, a numerical integration procedure will be used for the calculation of the Hankel integral. For this purpose it is most convenient to use dimensionless variables. These are introduced as

$$x = a\xi, \quad \zeta = z/a, \quad \rho = r/a, \quad \tau = ct/a^2, \quad \sigma = sa^2/c. \quad (8.96)$$

The integral (8.94) is then transformed into

$$\frac{\bar{p}}{q} = \int_0^\infty g(\sigma) J_1(x) J_0(\rho x) dx, \quad (8.97)$$

where now

$$g(\sigma) = \int_0^\infty G(\tau) \exp(-\sigma\tau) d\tau = \frac{\eta}{\alpha} \frac{\exp(-\zeta x) - \exp(-\zeta\sqrt{x^2 + \sigma})}{x^2 + b\sigma - x\sqrt{x^2 + \sigma}}. \quad (8.98)$$

The inverse Laplace transforms of the expressions in equation (8.98) are given in Appendix A. Using equations (A.11) and (A.13) the function $g(\sigma)$ can be written as

$$g(\sigma) = \frac{\eta}{(2b-1)\alpha} \{\exp(-\zeta x) f_2(x, \sigma) - f_1(x, \zeta, \sigma)\}. \quad (8.99)$$

It now follows that the inverse Laplace transformation is, with equations (A.12) and (A.14),

$$G(\tau) = \frac{\eta}{(2b-1)\alpha} \{\exp(-\zeta x) F_2(x, \tau) - F_1(x, \zeta, \tau)\}. \quad (8.100)$$

With equation (8.97) it follows that the pore pressure can be expressed as

$$\frac{p}{q} = \int_0^\infty G(\tau) J_1(x) J_0(\rho x) dx. \quad (8.101)$$

This Hankel integral transform may be evaluated numerically. The physical parameters now are the dimensionless radial distance $\rho = r/a$, the dimensionless depth $\zeta = z/a$, and the dimensionless time ct/a^2 . The integration parameter is x .

Contours of the pore pressure ratio p/q are shown in Figure 8.6 for $ct/a^2 = 0.0001$. The physical parameters were chosen as $\nu = 0$, $\alpha = 1$, $C = 0$. The interval between successive contours is $\Delta(p/q) = 0.05$. The maximum value of the pore pressure in this case is 0.911613. It can be seen from the figure that the consolidation process for such a small value of time is concentrated near the loaded part of the surface, as could be expected.

Figures 8.7 and 8.8 show the contours for $ct/a^2 = 0.01$ and $ct/a^2 = 1$. Then the consolidation process has been more advanced, with the maximum pore pressure being reduced to 0.776675, respectively 0.089985.

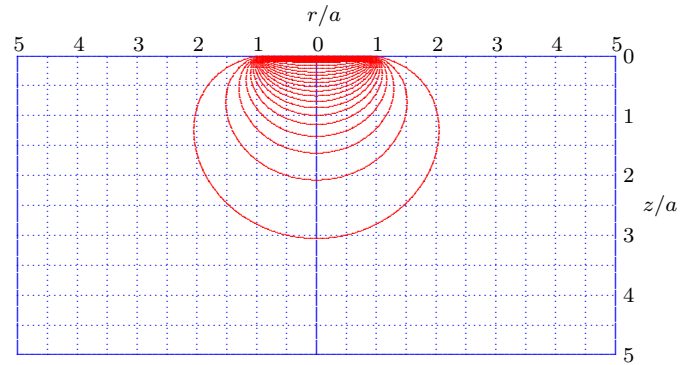
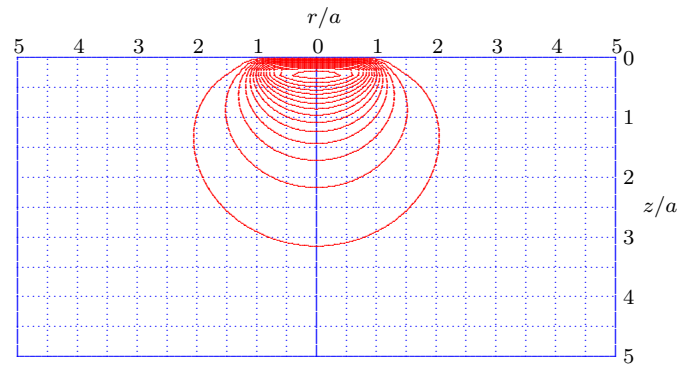
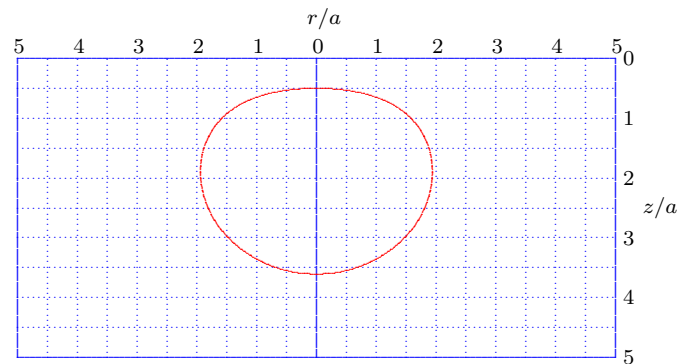
Figure 8.6: ASP : Pore pressure (Analytic), $ct/a^2 = 0.0001$.Figure 8.7: ASP : Pore pressure (Analytic), $ct/a^2 = 0.01$.Figure 8.8: ASP : Pore pressure (Analytic), $ct/a^2 = 1$.

8.3.6 Isotropic total stress

The isotropic total stress is often considered an important quantity, because its behaviour in time can be considered as characteristic for the coupling of the pore water pressure with the soil deformations. It can be related to the displacement functions D and F by equation (8.36),

$$\frac{\sigma_0}{2G} = -\frac{2}{3}\nabla^2 D + \frac{1}{3}(4 - \phi)\frac{\partial F}{\partial z}. \quad (8.102)$$

Using the expressions (8.46) and (8.50), and the expressions (8.61) and (8.63) for the constants A_2 and B_1 one obtains

$$\frac{\bar{\sigma}_0}{q} = \int_0^\infty m(s)J_1(\xi a)J_0(\xi r) d\xi, \quad (8.103)$$

where

$$m(s) = \int_0^\infty M(t)\exp(-st)dt = \frac{a}{3c} \frac{(4 - \phi)b\exp(-z\xi) - 2\exp(-z\sqrt{\xi^2 + s/c})}{\xi^2 + bs/c - \xi\sqrt{\xi^2 + \lambda^2}}, \quad (8.104)$$

with $b = \eta/\phi'$ and $\lambda^2 = s/c$.

Introducing dimensionless parameters $x = a\xi$, $\zeta = z/a$, $\rho = r/a$, $\tau = ct/a^2$ and $\sigma = a^2s/c$, equation (8.103) can be written as

$$\frac{\bar{\sigma}_0}{q} = \int_0^\infty m(\sigma)J_1(x)J_0(\rho x) dx, \quad (8.105)$$

where now

$$m(\sigma) = \int_0^\infty M(\tau)\exp(-\sigma\tau)d\tau = \frac{1}{3} \frac{(4 - \phi)b\exp(-\zeta x) - 2\exp(-\zeta\sqrt{x^2 + \sigma})}{x^2 + b\sigma - x\sqrt{x^2 + \sigma}}, \quad (8.106)$$

where, as before, $d = 1 - 1/b$, with $0 \leq d \leq 1$.

The inverse Laplace transforms of the expressions in equation (8.106) are given in Appendix A. Using equations (A.11) and (A.13) the function $m(\sigma)$ can be written as

$$m(\sigma) = \frac{1}{3(2b - 1)} \{(4 - \phi)b\exp(-\zeta x)f_2(x, \sigma) - 2f_1(x, \zeta, \sigma)\}. \quad (8.107)$$

It now follows that the inverse Laplace transformation is, with equations (A.12) and (A.14),

$$M(\tau) = \frac{1}{3(2b - 1)} \{(4 - \phi)b\exp(-\zeta x)F_2(x, \tau) - 2F_1(x, \zeta, \tau)\}. \quad (8.108)$$

With equation (8.103) it follows that the isotropic total stress can be expressed as

$$\frac{\sigma_0}{q} = \int_0^\infty M(\tau)J_1(x)J_0(\rho x) dx. \quad (8.109)$$

This Hankel integral transform may be evaluated numerically. The physical parameters in the solution are the dimensionless radial distance $\rho = r/a$, the dimensionless depth $\zeta = z/a$, and the dimensionless time ct/a^2 . The integration parameter is x .

A graphical representation of the distribution of the isotropic total stress can be produced using the computer program ASP. Contours of the stress ratio σ/q are shown in Figure 8.9 for $ct/a^2 = 0.0001$. The physical parameters were chosen as $\nu = 0$, $\alpha = 1$, $C = 0$. The interval between successive contours is $\Delta(\sigma/q) = 0.05$. The maximum value of the isotropic total stress in this case is 0.911613. This value is equal to the pore pressure, which indicates that the effective stresses are still very small.

Figures 8.10 and 8.11 show the contours for $ct/a^2 = 0.01$ and $ct/a^2 = 1$. The maximum isotropic total stress then is 0.799404, respectively 0.638941.

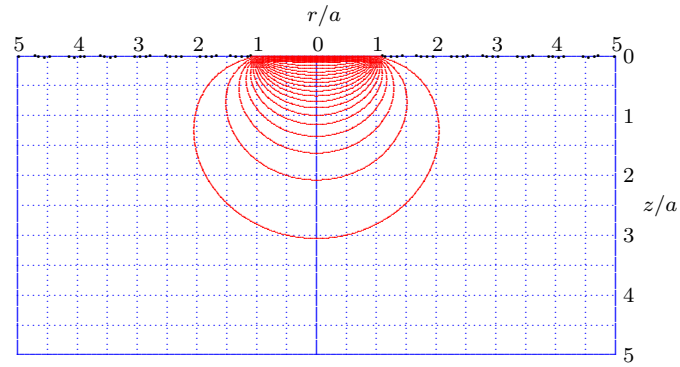

Figure 8.9: ASP : Isotropic total stress, $ct/a^2 = 0.0001$.

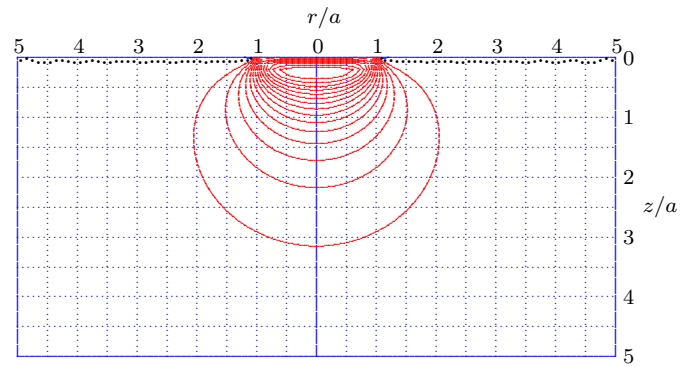

Figure 8.10: ASP : Isotropic total stress, $ct/a^2 = 0.01$.

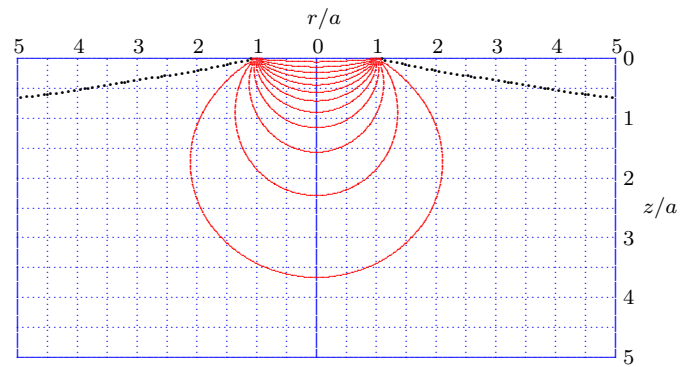

Figure 8.11: ASP : Isotropic total stress, $ct/a^2 = 1$.

8.3.7 Isotropic effective stress

The isotropic effective stress can be expressed into the volume change ε by

$$\sigma'_0 = -K\varepsilon. \quad (8.110)$$

With equation (8.26) it follows that

$$\frac{\sigma'_0}{2G} = (\eta - \frac{2}{3}) \{ \nabla^2 D - 2(1 - \phi) \frac{\partial F}{\partial z} \}. \quad (8.111)$$

Using the expressions (8.46) and (8.50), and the expressions (8.61) and (8.63) for the constants A_2 and B_1 one obtains

$$\frac{\bar{\sigma}'_0}{q} = \int_0^\infty h(s) J_1(a\xi) J_0(r\xi) d\xi, \quad (8.112)$$

where

$$h(s) = \int_0^\infty H(t) \exp(-st) dt = \frac{a(\eta - \frac{2}{3})}{c} \frac{\exp(-z\sqrt{\xi^2 + s/c}) - 2b(1 - \phi) \exp(-z\xi)}{\xi^2 + bs/c - \xi\sqrt{\xi^2 + \lambda^2}}, \quad (8.113)$$

where, as before, $b = \eta/\phi'$ and $\lambda^2 = s/c$.

Introducing dimensionless parameters $x = a\xi$, $\zeta = z/a$, $\rho = r/a$, $\tau = ct/a^2$ and $\sigma = a^2s/c$, equation (8.112) can be written as

$$\frac{\bar{\sigma}'_0}{q} = \int_0^\infty h(\sigma) J_1(x) J_0(\rho x) dx, \quad (8.114)$$

where now

$$h(\sigma) = \int_0^\infty H(\tau) \exp(-\sigma\tau) d\tau = (\eta - \frac{2}{3}) \frac{\exp(-\zeta\sqrt{x^2 + \sigma}) - 2b(1 - \phi) \exp(-\zeta x)}{x^2 + b\sigma - x\sqrt{x^2 + \sigma}}, \quad (8.115)$$

where, as before, $d = 1 - 1/b$, with $0 \leq d \leq 1$.

The inverse Laplace transforms of the expressions in equation (8.115) are given in Appendix A. Using equations (A.11) and (A.13) the function $h(\sigma)$ can be written as

$$h(\sigma) = \frac{\eta - \frac{2}{3}}{2b - 1} \{ f_1(x, \zeta, \sigma) - 2b(1 - \phi) \exp(-\zeta x) f_2(x, \sigma) - 2 \}. \quad (8.116)$$

It now follows that the inverse Laplace transformation is, with equations (A.12) and (A.14),

$$H(\tau) = \frac{\eta - \frac{2}{3}}{2b - 1} \{ F_1(x, \zeta, \tau) - 2b(1 - \phi) \exp(-\zeta x) F_2(x, \tau) \}. \quad (8.117)$$

With equation (8.114) it follows that the isotropic effective stress can be expressed as

$$\frac{\sigma'_0}{q} = \int_0^\infty H(\tau) J_1(x) J_0(\rho x) dx. \quad (8.118)$$

This Hankel integral transform may be evaluated numerically. It may be noted that the isotropic effective stress can also be calculated as the difference of the isotropic total stress and the pore pressure, of course.

A graphical representation of the distribution of the isotropic effective total stress can be produced using the computer program ASP. Contours of the stress ratio σ'/q are shown in Figure 8.12 for $ct/a^2 = 0.0001$. The physical parameters were chosen as $\nu = 0$, $\alpha = 1$, $C = 0$. The interval between successive contours is $\Delta(\sigma/q) = 0.05$. The maximum value of the isotropic effective stress in this case is 0.365028, but the figure indicates that non-zero effective stresses occur only near the loaded boundary segment for such small values of time.

Figures 8.13 and 8.14 show the contours for $ct/a^2 = 0.01$ and $ct/a^2 = 1$. The maximum isotropic total stress then is 0.489983, respectively 0.651797.

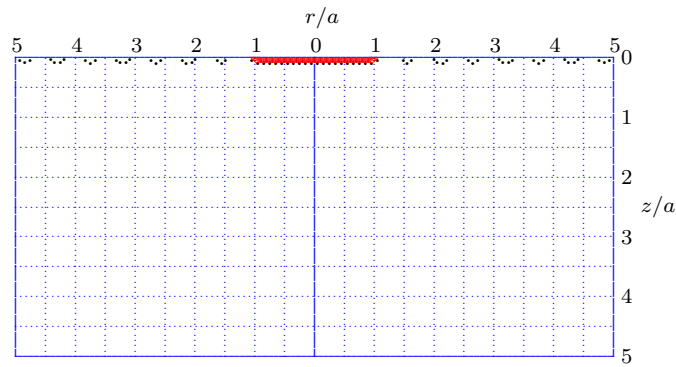
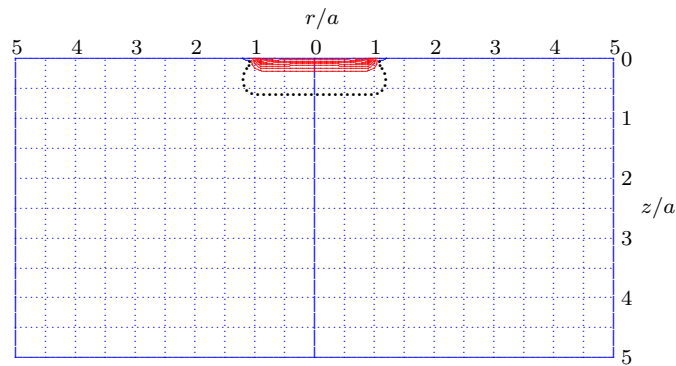
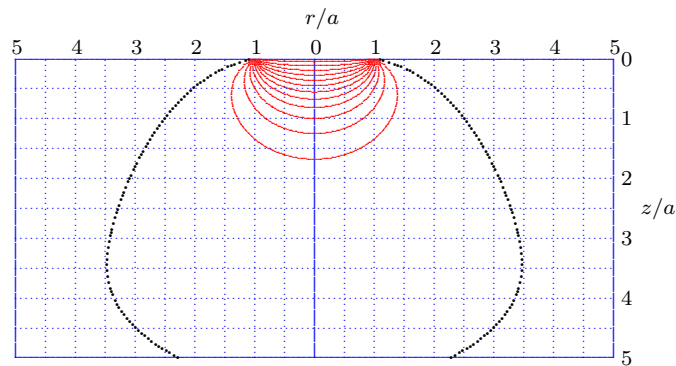
Figure 8.12: ASP : Isotropic effective stress, $ct/a^2 = 0.0001$.Figure 8.13: ASP : Isotropic effective stress, $ct/a^2 = 0.01$.Figure 8.14: ASP : Isotropic effective stress, $ct/a^2 = 1$.

8.3.8 Initial pore pressure

In problems such as the one considered here, with a load that is applied in a single step at time $t = 0$, it follows from the basics of the theory of consolidation that the behaviour of the porous material at the moment of loading can be considered to be a linear elastic response with the compression modulus K replaced by the undrained compression modulus K_u , defined as

$$K_u = K + \alpha^2/S, \quad (8.119)$$

and the initial value of the pore pressure is

$$t = 0 : p = \frac{\alpha\sigma_0}{\alpha^2 + KS}, \quad (8.120)$$

see Chapter 1, equations (1.57) and (1.59).

In case of a porous material with incompressible particles, saturated with an incompressible fluid $\alpha = 1$ and $S = 0$, it follows that the undrained compression modulus $K_u \rightarrow \infty$, and the initial pore pressure equals the isotropic total stress. In such an undrained analysis an infinite value for the compression modulus can be simulated by taking $\nu \rightarrow \frac{1}{2}$.

For the present problem contours of the isotropic total stress in an elastic material with $\nu = \frac{1}{2}$ are shown in Figure 8.15. The maximum value of the stress, calculated by a computer program (ASE) for axially

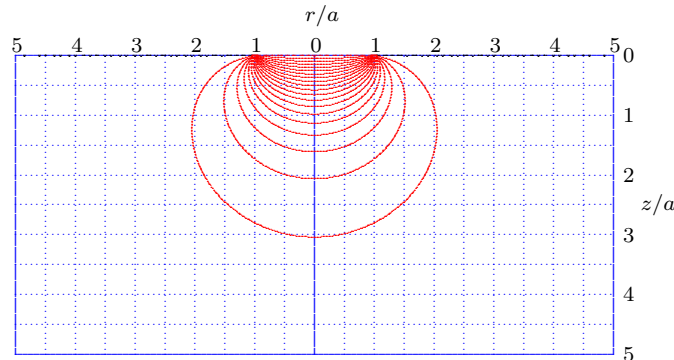

Figure 8.15: Disk load, Isotropic stress, $\nu = 0.5$.

symmetric elastic computations, is about $\sigma_0/q = 1.028$, which is slightly larger than the theoretical value 1, probably because of the approximations in the numerical integration of a Hankel integral transform.

The results of a computation of the pore pressures in a porous material, with $\alpha = 1$, $S = 0$, $\nu = 0$, and a very small value of time, have been shown already in Figure 8.6. The agreement is very good, except in the immediate vicinity of the loaded area, where drainage has already reduced the pore pressure to zero.

8.3.9 Numerical inversion of the Laplace transforms

Because for other stress components, to be considered later, analytic inversion of the Laplace transformation seems to be impossible, a numerical inversion method may be considered. In order to check the applicability of such a numerical inversion technique this will first be used for the contours of the pore pressure, which have already been evaluated earlier in this chapter, using an analytic Laplace inversion.

The numerical inversion method to be used is Talbot's method (Talbot, 1979). This method will be used for the numerical inversion of the function $g(\sigma)$, appearing in the analysis of the pore pressure, see equation (8.99),

$$g(\sigma) = \frac{\eta}{(2b-1)\alpha} \{ \exp(-\zeta x) f_2(x, \sigma) - f_1(x, \zeta, \sigma) \}. \quad (8.121)$$

A convenient algorithm for the calculation of the inverse Laplace transform $G(\tau)$ is (Abate & Whitt, 2006)

$$G(\tau) = \frac{2}{5\tau} \sum_{k=0}^{M-1} \Re\{\gamma_k g(\delta_k/\tau)\}, \quad (8.122)$$

where M is an integer indicating the number of terms in the approximation (e.g. $M = 10$ or $M = 20$), and where

$$\delta_0 = \frac{2M}{5}, \quad \delta_k = \frac{2k\pi}{5} [\cot(k\pi/M) + i], \quad 0 < k < M, \quad (8.123)$$

$$\gamma_0 = \frac{\exp(\delta_0)}{2}, \quad \gamma_k = \left\{ 1 + i(k\pi/M)(1 + [\cot(k\pi/M)]^2) - i \cot(k\pi/M) \right\} \exp(\delta_k), \quad 0 < k < M. \quad (8.124)$$

It may be noted that for $k > 0$ the coefficients δ_k and γ_k are complex. It should also be noted that the coefficients depend only upon the value of M , and thus have to be calculated just once. It has been shown (Abate & Whitt, 2006) that the Talbot approximation usually is accurate to about $0.6 M$ significant digits, so that choosing $M = 10$ should give very accurate results.

The pore pressure can be expressed as given in equation (8.101),

$$\frac{p}{q} = \int_0^\infty G(\tau) J_1(x) J_0(\rho x) dx. \quad (8.125)$$

This Hankel integral transform is evaluated numerically. The physical parameters are the dimensionless radial distance $\rho = r/a$, the dimensionless depth $\zeta = z/a$, and the dimensionless time $\tau = ct/a^2$. The integration parameter is x .

For given values of ρ , ζ and τ it is necessary to calculate M values of the function $G(\tau)$ numerically. This involves some complex algebra, but this should not pose serious difficulties for modern software. The integral over the variable x in equation (8.125) has been computed numerically, using Simpson's algorithm. The semi-infinite interval $0 < x < \infty$ may be restricted to the interval $0 < x < L$, where L can be determined iteratively, starting from an initial guess, say $L = 200$. This interval is subdivided for the numerical integration into N equal parts, where N is a suitably large number, say $N = 1000$. All computations have been carried out using the program ASP, written in C++. Although the program allows for arbitrary values ν , α and KS , the product of the compression modulus of the soil and its storativity, the examples have been calculated, as before, for a soil with incompressible particles and containing an incompressible pore fluid, so that Biot's coefficient $\alpha = 1$ and the storativity $S = 0$. The value of Poisson's ratio has been assumed to be $\nu = 0$.

The results of the program ASP for computations using analytical and numerical inversion of the Laplace transform are shown, for the case $\tau = 0.1$, in Figures 8.16 and 8.17. The number of terms in the Talbot

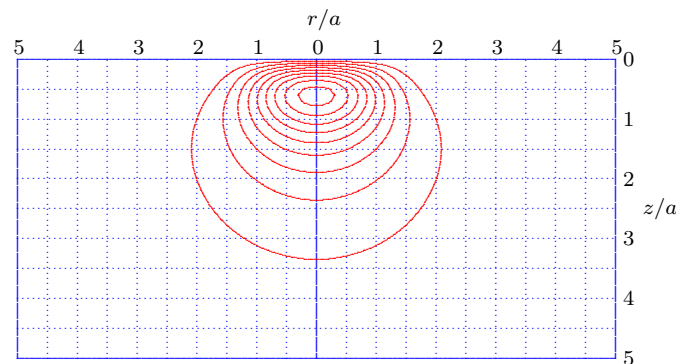

Figure 8.16: ASP : Pore pressure (Analytic), $ct/a^2 = 0.1$.

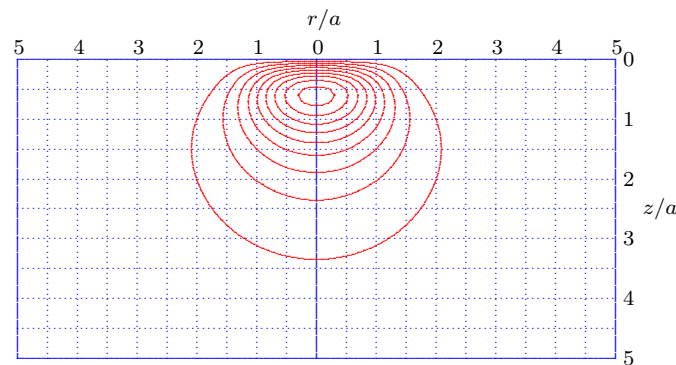

Figure 8.17: ASP : Pore pressure (Talbot), $ct/a^2 = 0.1$.

method has been taken equal to 10. The maximum value of p/q is 0.474817, in both cases. The figures indicate that the results can not be distinguished from each other.

8.3.10 Vertical total stress

The vertical total stress has been expressed in equation (8.56) in the form

$$\frac{\bar{\sigma}_{zz}}{2G} = \int_0^\infty \{A_1 \xi^2 \exp(-z\xi) + A_2 \xi^2 \exp(-z\sqrt{\xi^2 + \lambda^2}) - B_1 \xi(\phi + z\xi) \exp(-z\xi)\} J_0(r\xi) d\xi. \quad (8.126)$$

In view of the nature of the expressions for the constants A_1 , A_2 and B_1 , see equations (8.74), (8.72) and (8.73), the vertical total stress is written as

$$\frac{\sigma_{zz}}{q} = F(t) = \int_0^\infty S_{zz}(t) J_1(\xi a) J_0(\xi r) d\xi, \quad (8.127)$$

or, in the form of a Laplace transform,

$$\frac{\bar{\sigma}_{zz}}{q} = f(s) = \int_0^\infty s_{zz}(s) J_1(\xi a) J_0(\xi r) d\xi. \quad (8.128)$$

From equations (8.126) and (8.128) the function $s_{zz}(s)$ is found to be, with $b = \eta/\phi'$ and $\lambda^2 = s/c$,

$$s_{zz}(s) = \frac{a}{s} \frac{\xi^2 \exp(-z\sqrt{\xi^2 + s/c}) + \{b(1 + z\xi)s/c - \xi\sqrt{\xi^2 + s/c}\} \exp(-z\xi)}{\xi^2 + bs/c - \xi\sqrt{\xi^2 + s/c}}. \quad (8.129)$$

The inverse Laplace transform will be obtained using Talbot's method,

$$S_{zz}(t) = \frac{2}{5t} \sum_{k=0}^{M-1} \Re\{\gamma_k s_{zz}(\delta_k/t)\}. \quad (8.130)$$

Substitution into equation (8.127) gives

$$\frac{\sigma_{zz}}{q} = \frac{2}{5t} \int_0^\infty \sum_{k=0}^{M-1} \Re\{\gamma_k s_{zz}(\delta_k/t)\} J_1(\xi a) J_0(\xi r) d\xi. \quad (8.131)$$

Introducing dimensionless variables $x = a\xi$ and $\rho = r/a$ this equation can be written as

$$\frac{\sigma_{zz}}{q} = \frac{2}{5} \int_0^\infty \sum_{k=0}^{M-1} \Re\left\{ \frac{\gamma_k s_{zz}(\delta_k/t)}{at} \right\} J_1(x) J_0(\rho x) dx. \quad (8.132)$$

It follows from equation (8.129) that

$$\frac{s_{zz}(\delta_k/t)}{at} = \frac{\xi^2 \exp(-z\sqrt{\xi^2 + \delta_k/ct}) + \{b(1 + z\xi)\delta_k/ct - \xi\sqrt{\xi^2 + \delta_k/ct}\} \exp(-z\xi)}{\delta_k\{\xi^2 + b\delta_k/ct - \xi\sqrt{\xi^2 + \delta_k/ct}\}}, \quad (8.133)$$

or, using dimensionless variables $x = a\xi$, $\zeta = z/a$, and $\tau = ct/a^2$,

$$\frac{s_{zz}(\delta_k/t)}{at} = \frac{x^2 \exp(-\zeta\sqrt{x^2 + \delta_k/\tau}) + \{b(1 + \zeta x)\delta_k/\tau - x\sqrt{x^2 + \delta_k/\tau}\} \exp(-\zeta x)}{\delta_k\{x^2 + b\delta_k/\tau - x\sqrt{x^2 + \delta_k/\tau}\}}, \quad (8.134)$$

Values of the parameter σ_{zz}/q can now be calculated using equations (8.132) and (8.134). The calculations can be performed by the program ASP.

Contours for the case $\nu = 0$, $\alpha = 1$, $KS = 0$ are shown in Figures 8.18 and 8.19, for $ct/a^2 = 0.1$ and $ct/a^2 = 10000$, respectively. In both cases the maximum value is $\sigma_{zz}/q = 1.015437$.

The limiting values for $t \rightarrow \infty$ can be obtained using the Laplace transform property (Churchill, 1972)

$$\lim_{t \rightarrow \infty} F(t) = \lim_{s \rightarrow 0} s f(s). \quad (8.135)$$

Application of this theorem to the expressions (8.126) and (8.127) gives

$$\lim_{t \rightarrow \infty} \frac{\sigma_{zz}}{q} = \lim_{s \rightarrow 0} \frac{s \bar{\sigma}_{zz}}{q} = \int_0^\infty a(1 + \xi z) J_0(\xi r) J_1(\xi a) \exp(-\xi z) d\xi. \quad (8.136)$$

For $t \rightarrow \infty$ the consolidation process is practically completed, the pore pressures are zero, and the total stresses should be equal to those in the elastic case. The expression (8.136) is indeed in agreement with a result from the theory of elasticity, for a uniform load on a circular area of an elastic half space. These results are shown in graphical form in Figure 8.20, as calculated by a program (ASE) for elastostatic stress computations. Indeed the stresses appear to be the same as those in Figure 8.19. Actually, there appears to be little difference with the stresses at short values of time as well, as shown in Figure 8.18. The vertical total stresses appear not to change much during the consolidation process. This is an interesting observation, that will be used in later chapters to obtain approximate solutions, and to deduce numerical (finite element) solutions.

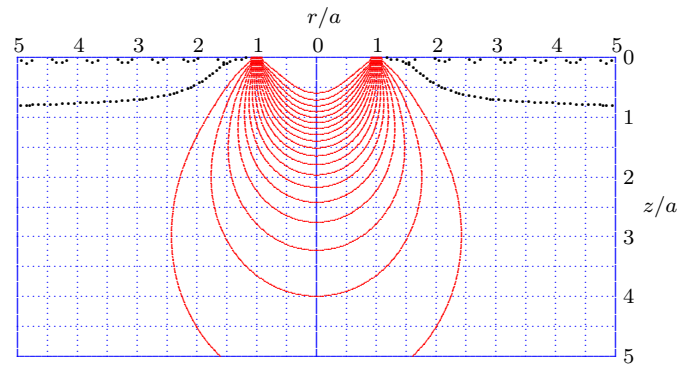
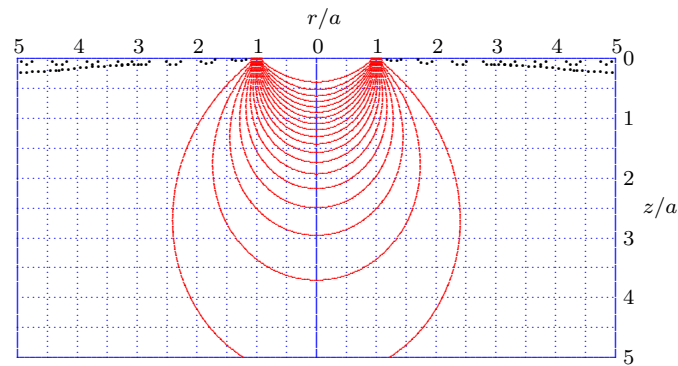
Figure 8.18: ASP : Vertical total stress, $ct/a^2 = 0.1$.Figure 8.19: ASP : Vertical total stress, $ct/a^2 = 10000$.

8.3.11 Vertical effective stress

Because $\sigma_{zz} = \sigma'_{zz} + \alpha p$, the vertical effective stress can easily be obtained from the expressions for the vertical total stress and the pore pressure. For the same values of parameters the contours of the vertical effective stress are shown in Figure 8.21, for $ct/a^2 = 0.1$. For a very large value of time, $ct/a^2 = 10000$, the pore pressures have been dissipated, and the vertical effective stress is equal to the vertical total stress, as shown in Figure 8.19.

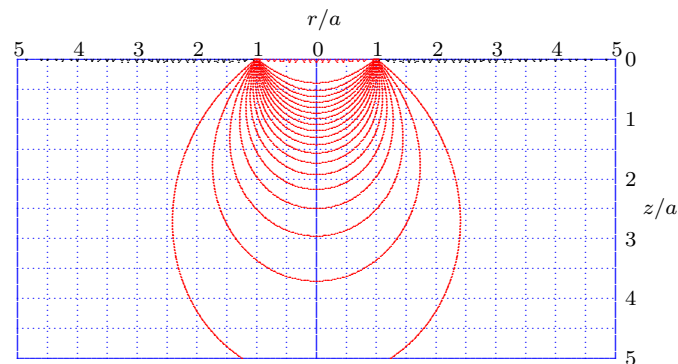
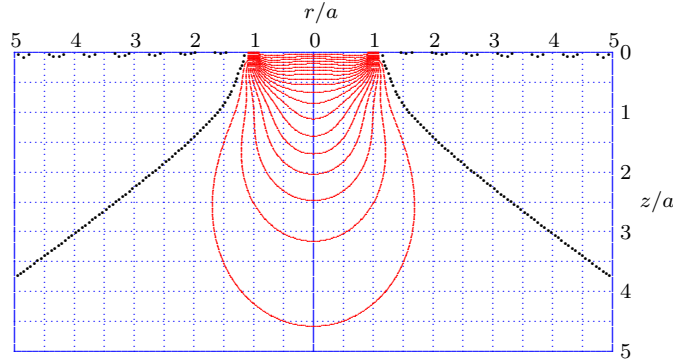

Figure 8.20: Disk load, Vertical stress.

Figure 8.21: ASP : Vertical effective stress, $ct/a^2 = 0.1$.

8.3.12 Radial total stress

The radial total stress has been expressed in equation (8.65) in the form

$$\begin{aligned} \frac{\bar{\sigma}_{rr}}{2G} = & - \int_0^\infty \{ [A_1 \xi^2 + B_1 \xi (2 - \phi - z\xi)] \exp(-z\xi) + A_2 (\xi^2 + \lambda^2) \exp(-z\sqrt{\xi^2 + \lambda^2}) \} J_0(r\xi) d\xi \\ & + \int_0^\infty \{ (A_1 \xi^2 - B_1 z \xi^2) \exp(-z\xi) + A_2 \xi^2 \exp(-z\sqrt{\xi^2 + \lambda^2}) \} \frac{J_1(r\xi)}{r\xi} d\xi. \end{aligned} \quad (8.137)$$

The constants A_1 , A_2 and B_1 have been given in equations (8.74), (8.72) and (8.73). In view of the character of the expressions for these constants the radial total stress is written as

$$\frac{\sigma_{rr}}{q} = \int_0^\infty S_{rr}(t) J_1(\xi a) J_0(\xi r) d\xi + \int_0^\infty T_{rr}(t) J_1(\xi a) \frac{J_1(\xi r)}{\xi r} d\xi, \quad (8.138)$$

or, in the form of Laplace transforms,

$$\frac{\bar{\sigma}_{rr}}{q} = \int_0^\infty s_{rr}(s) J_1(\xi a) J_0(\xi r) d\xi + \int_0^\infty t_{rr}(s) J_1(\xi a) \frac{J_1(\xi r)}{\xi r} d\xi, \quad (8.139)$$

where the functions $s_{rr}(s)$ and $t_{rr}(s)$ are the Laplace transforms of $S_{rr}(t)$ and $T_{rr}(t)$.

Elaborating equation (8.137) with the given values of the constants A_1 , A_2 and B_1 shows that the functions $s_{rr}(s)$ and $t_{rr}(s)$ are, with $b = \eta/\phi'$ and $\lambda^2 = s/c$,

$$s_{rr}(s) = \frac{a}{s} \frac{-(\xi^2 + s/c) \exp(-z\sqrt{\xi^2 + s/c}) + \{\xi\sqrt{\xi^2 + s/c} + (bs/c)(1 - z\xi)\} \exp(-z\xi)}{\xi^2 + bs/c - \xi\sqrt{\xi^2 + s/c}}, \quad (8.140)$$

$$t_{rr}(s) = \frac{a}{s} \frac{\xi^2 \exp(-z\sqrt{\xi^2 + s/c}) - \{\xi\sqrt{\xi^2 + s/c} - (bs/c)(1 - \phi + z\xi)\} \exp(-z\xi)}{\xi^2 + bs/c - \xi\sqrt{\xi^2 + s/c}}. \quad (8.141)$$

Again the inverse Laplace transforms will be performed using Talbot's method,

$$S_{rr}(t) = \frac{2}{5t} \sum_{k=0}^{M-1} \Re\{\gamma_k s_{rr}(\delta_k/t)\}, \quad T_{rr}(t) = \frac{2}{5t} \sum_{k=0}^{M-1} \Re\{\gamma_k t_{rr}(\delta_k/t)\}. \quad (8.142)$$

Substitution of these two expressions into equation (8.139) gives

$$\begin{aligned} \frac{\sigma_{rr}}{q} = & \frac{2}{5t} \int_0^\infty \sum_{k=0}^{M-1} \Re\{\gamma_k s_{rr}(\delta_k/t)\} J_1(\xi a) J_0(\xi r) d\xi + \\ & \frac{2}{5t} \int_0^\infty \sum_{k=0}^{M-1} \Re\{\gamma_k t_{rr}(\delta_k/t)\} J_1(\xi a) \frac{J_1(\xi r)}{\xi r} d\xi. \end{aligned} \quad (8.143)$$

Using dimensionless variables $x = a\xi$ and $\rho = r/a$ this equation can be written as

$$\frac{\sigma_{rr}}{q} = \frac{2}{5} \int_0^\infty \sum_{k=0}^{M-1} \Re\left\{ \frac{\gamma_k s_{rr}(\delta_k/t)}{at} \right\} J_1(x) J_0(\rho x) dx + \frac{2}{5} \int_0^\infty \sum_{k=0}^{M-1} \Re\left\{ \frac{\gamma_k t_{rr}(\delta_k/t)}{at} \right\} J_1(x) \frac{J_1(\rho x)}{\rho x} dx. \quad (8.144)$$

It follows from equations (8.140) and (8.141) that

$$\frac{s_{rr}(\delta_k/t)}{at} = \frac{-(\xi^2 + \delta_k/ct) \exp(-z\sqrt{\xi^2 + \delta_k/ct}) + \{\xi\sqrt{\xi^2 + \delta_k/ct} + (b\delta_k/ct)(1 - z\xi)\} \exp(-z\xi)}{\delta_k\{\xi^2 + b\delta_k/ct - \xi\sqrt{\xi^2 + \delta_k/ct}\}}, \quad (8.145)$$

$$\frac{t_{rr}(\delta_k/t)}{at} = \frac{\xi^2 \exp(-z\sqrt{\xi^2 + \delta_k/ct}) - \{\xi\sqrt{\xi^2 + \delta_k/ct} - (b\delta_k/ct)(1 - \phi + z\xi)\} \exp(-z\xi)}{\delta_k\{\xi^2 + b\delta_k/ct - \xi\sqrt{\xi^2 + \delta_k/ct}\}}. \quad (8.146)$$

Using dimensionless variables $x = a\xi$, $\zeta = z/a$ and $\tau = ct/a^2$ these equations can be written as

$$\frac{s_{rr}(\delta_k/t)}{at} = \frac{-(x^2 + \delta_k/\tau) \exp(-\zeta\sqrt{x^2 + \delta_k/\tau}) + \{x\sqrt{x^2 + \delta_k/\tau} + (b\delta_k/\tau)(1 - \zeta x)\} \exp(-\zeta x)}{\delta_k\{x^2 + b\delta_k/\tau - x\sqrt{x^2 + \delta_k/\tau}\}}, \quad (8.147)$$

$$\frac{t_{rr}(\delta_k/t)}{at} = \frac{x^2 \exp(-\zeta\sqrt{x^2 + \delta_k/\tau}) - \{x\sqrt{x^2 + \delta_k/\tau} - (b\delta_k/\tau)(1 - \phi + \zeta x)\} \exp(-\zeta x)}{\delta_k\{x^2 + b\delta_k/\tau - x\sqrt{x^2 + \delta_k/\tau}\}}. \quad (8.148)$$

Values of the parameter σ_{rr}/q can now be calculated using equations (8.144), (8.147) and (8.148). The calculations can be performed by the program ASP. Contours for the case $\nu = 0$, $\alpha = 1$, $KC = 0$ are shown in Figures 8.22 and 8.23, for $ct/a^2 = 0.1$ and $ct/a^2 = 10000$, respectively. For $ct/a^2 = 10000$ the consolidation

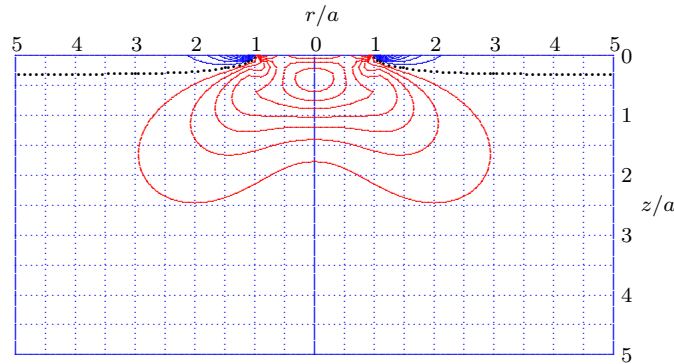

Figure 8.22: ASP : Radial total stress, $ct/a^2 = 0.1$.

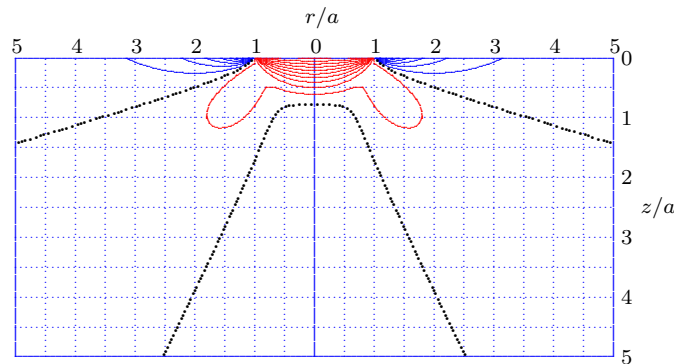

Figure 8.23: ASP : Radial total stress, $ct/a^2 = 10000$.

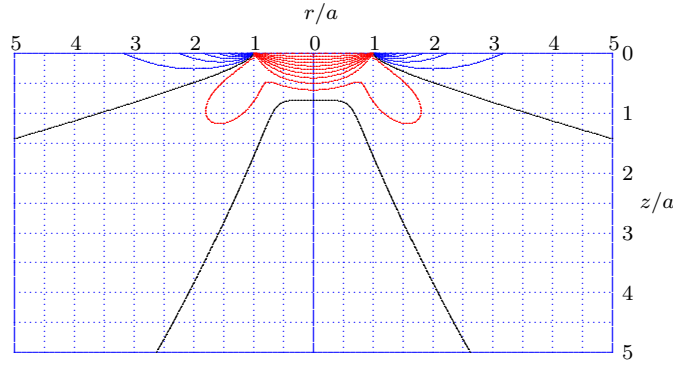

Figure 8.24: Disk load, Radial stress.

process is practically completed, the pore pressures are zero, and the total stresses should be equal to those in the elastic case. The results obtained using a program for elastic stress computations are shown in Figure 8.24. Indeed the stresses appear to be very similar to those in Figure 8.23.

As in the case of the vertical total stress, see the previous paragraph, it is interesting to check whether the formal solution of the consolidation problem tends towards the elastic solution if $t \rightarrow \infty$, when the pore pressures have been completely dissipated. This can be achieved by determining the limit of the radial stress for $t \rightarrow \infty$ by the property of the Laplace transform that

$$\lim_{t \rightarrow \infty} \frac{\sigma_{rr}}{q} = \lim_{s \rightarrow 0} \frac{s \bar{\sigma}_{rr}}{q}. \quad (8.149)$$

Actually, the elastic solution of the problem indicates that the left hand side of this equation is

$$\lim_{t \rightarrow \infty} \frac{\sigma_{rr}}{q} = a \int_0^\infty \left\{ (1 - z\xi) J_0(r\xi) - (1 - 2\nu - z\xi) \frac{J_1(r\xi)}{r\xi} \right\} J_1(a\xi) \exp(-z\xi) d\xi. \quad (8.150)$$

It follows from equation (8.139) that the condition (8.149) would be satisfied if

$$\lim_{s \rightarrow 0} \frac{s s_{rr}}{a} = (1 - z\xi) \exp(-z\xi), \quad (8.151)$$

and

$$\lim_{s \rightarrow 0} \frac{s t_{rr}}{a} = -(1 - 2\nu - z\xi) \exp(-z\xi). \quad (8.152)$$

It can be verified from the solution of the consolidation problem, as expressed by equations (8.140) and (8.141), that the conditions (8.151) and (8.152) are indeed satisfied. In proving that the second condition is satisfied it must be noted that the definitions of the parameters b , η , ϕ and ϕ' imply that

$$\frac{1 - 2b + 2b\phi}{1 - 2b} = 2\nu - 1. \quad (8.153)$$

Using this result the first two terms in the right hand side of equation (8.152) may be obtained.

8.3.13 Tangential total stress

The tangential total stress has been expressed in equation (8.67) in the form

$$\begin{aligned} \frac{\bar{\sigma}_{tt}}{2G} = & - \int_0^\infty \left\{ (2 - \phi) B_1 \xi \exp(-z\xi) + A_2 \lambda^2 \exp(-z\sqrt{\xi^2 + \lambda^2}) \right\} J_0(r\xi) d\xi \\ & - \int_0^\infty \left\{ (A_1 \xi^2 - B_1 z \xi^2) \exp(-z\xi) + A_2 \xi^2 \exp(-z\sqrt{\xi^2 + \lambda^2}) \right\} \frac{J_1(r\xi)}{r\xi} d\xi. \end{aligned} \quad (8.154)$$

The constants A_1 , A_2 and B_1 have been given in equations (8.74), (8.72) and (8.73). In view of the character of the expressions for these constants the tangential total stress is written as

$$\frac{\sigma_{tt}}{q} = \int_0^\infty S_{tt}(t) J_1(\xi a) J_0(\xi r) d\xi + \int_0^\infty T_{tt}(t) J_1(\xi a) \frac{J_1(\xi r)}{\xi r} d\xi, \quad (8.155)$$

or, in the form of Laplace transforms,

$$\frac{\bar{\sigma}_{tt}}{q} = \int_0^\infty s_{tt}(s) J_1(\xi a) J_0(\xi r) d\xi + \int_0^\infty t_{tt}(s) J_1(\xi a) \frac{J_1(\xi r)}{\xi r} d\xi, \quad (8.156)$$

where the functions $s_{tt}(s)$ and $t_{tt}(s)$ are the Laplace transforms of $S_{tt}(t)$ and $T_{tt}(t)$.

Elaborating equation (8.154) with the given values of the constants A_1 , A_2 and B_1 shows that the functions $s_{tt}(s)$ and $t_{tt}(s)$ are, with $b = \eta/\phi'$ and $\lambda^2 = s/c$,

$$s_{tt}(s) = \frac{a}{s} \frac{-(s/c) \exp(-z\sqrt{\xi^2 + s/c}) + (2 - \phi)(bs/c) \exp(-z\xi)}{\xi^2 + bs/c - \xi\sqrt{\xi^2 + s/c}}, \quad (8.157)$$

$$t_{tt}(s) = -\frac{a}{s} \frac{\xi^2 \exp(-z\sqrt{\xi^2 + s/c}) - \{\xi\sqrt{\xi^2 + s/c} - (bs/c)(1 - \phi + z\xi) \exp(-z\xi)\}}{\xi^2 + bs/c - \xi\sqrt{\xi^2 + s/c}}. \quad (8.158)$$

Again the inverse Laplace transforms will be performed using Talbot's method,

$$S_{tt}(t) = \frac{2}{5t} \sum_{k=0}^{M-1} \Re\{\gamma_k s_{tt}(\delta_k/t)\}, \quad T_{tt}(t) = \frac{2}{5t} \sum_{k=0}^{M-1} \Re\{\gamma_k t_{tt}(\delta_k/t)\}. \quad (8.159)$$

Substitution of these two expressions into equation (8.156) gives

$$\begin{aligned} \frac{\sigma_{tt}}{q} = \frac{2}{5t} \int_0^\infty \sum_{k=0}^{M-1} \Re\{\gamma_k s_{tt}(\delta_k/t)\} J_1(\xi a) J_0(\xi r) d\xi + \\ \frac{2}{5t} \int_0^\infty \sum_{k=0}^{M-1} \Re\{\gamma_k t_{tt}(\delta_k/t)\} J_1(\xi a) \frac{J_1(\xi r)}{\xi r} d\xi. \end{aligned} \quad (8.160)$$

Using dimensionless variables $x = a\xi$ and $\rho = r/a$ this equation can be written as

$$\begin{aligned} \frac{\sigma_{tt}}{q} = \frac{2}{5} \int_0^\infty \sum_{k=0}^{M-1} \Re\left\{\frac{\gamma_k s_{tt}(\delta_k/t)}{at}\right\} J_1(x) J_0(\rho x) dx + \\ \frac{2}{5} \int_0^\infty \sum_{k=0}^{M-1} \Re\left\{\frac{\gamma_k t_{tt}(\delta_k/t)}{at}\right\} J_1(x) \frac{J_1(\rho x)}{\rho x} dx. \end{aligned} \quad (8.161)$$

It follows from equations (8.157) and (8.158) that

$$\frac{s_{tt}(\delta_k/t)}{at} = \frac{-(\delta_k/ct) \exp(-z\sqrt{\xi^2 + \delta_k/ct}) + (2 - \phi)(b\delta_k/ct) \exp(-z\xi)}{\delta_k\{\xi^2 + b\delta_k/ct - \xi\sqrt{\xi^2 + \delta_k/ct}\}}, \quad (8.162)$$

$$\frac{t_{tt}(\delta_k/t)}{at} = -\frac{\xi^2 \exp(-z\sqrt{\xi^2 + \delta_k/ct}) - \{\xi\sqrt{\xi^2 + \delta_k/ct} - (b\delta_k/ct)(1 - \phi + z\xi)\} \exp(-z\xi)}{\delta_k\{\xi^2 + b\delta_k/ct - \xi\sqrt{\xi^2 + \delta_k/ct}\}}. \quad (8.163)$$

Using dimensionless variables $x = a\xi$, $\zeta = z/a$ and $\tau = ct/a^2$ these equations can be written as

$$\frac{s_{tt}(\delta_k/t)}{at} = \frac{-(\delta_k/\tau) \exp(-\zeta\sqrt{x^2 + \delta_k/\tau}) + (2 - \phi)(b\delta_k/\tau) \exp(-\zeta x)}{\delta_k\{x^2 + b\delta_k/\tau - x\sqrt{x^2 + \delta_k/\tau}\}}, \quad (8.164)$$

$$\frac{t_{tt}(\delta_k/t)}{at} = -\frac{x^2 \exp(-\zeta\sqrt{x^2 + \delta_k/\tau}) - \{x\sqrt{x^2 + \delta_k/\tau} - (b\delta_k/\tau)(1 - \phi + \zeta x)\} \exp(-\zeta x)}{\delta_k\{x^2 + b\delta_k/\tau - x\sqrt{x^2 + \delta_k/\tau}\}}. \quad (8.165)$$

Values of the parameter σ_{tt}/q can now be calculated using equations (8.161), (8.164) and (8.165). The calculations can be performed by the program ASP. Contours for the case $\nu = 0$, $\alpha = 1$, $KC = 0$ are shown in Figures 8.25 and 8.26, for $ct/a^2 = 0.1$ and $ct/a^2 = 10000$, respectively. For $ct/a^2 = 10000$ the consolidation process is practically completed, the pore pressures are zero, and the total stresses should be equal to those in the elastic case. The results obtained using a program (ASE) for elastic stress computations are shown in Figure 8.27. Indeed the stresses appear to be very similar to those in Figure 8.26. As in previous cases, it is interesting to check whether the formal solution of the consolidation problem tends towards the elastic solution

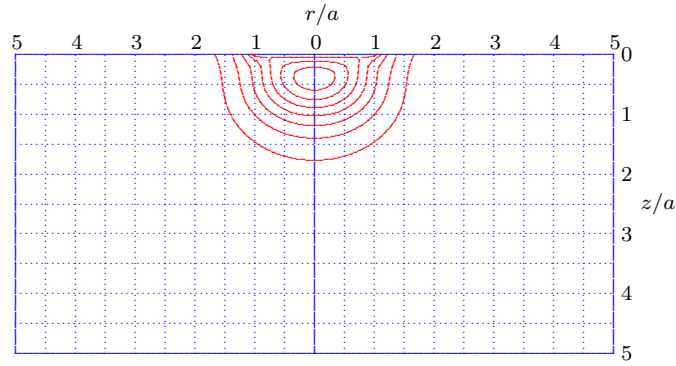

Figure 8.25: ASP : Tangential total stress, $ct/a^2 = 0.1$.

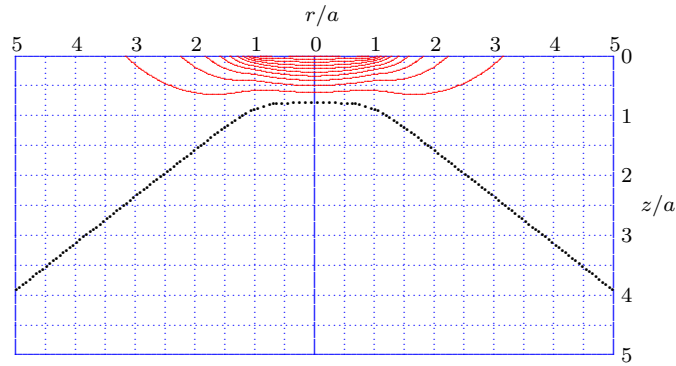

Figure 8.26: ASP : Tangential total stress, $ct/a^2 = 10000$.

if $t \rightarrow \infty$, when the pore pressures have been completely dissipated. This can be achieved by determining the limit of the radial stress for $t \rightarrow \infty$ by the property of the Laplace transform that

$$\lim_{t \rightarrow \infty} \frac{\sigma_{tt}}{q} = \lim_{s \rightarrow 0} \frac{s \bar{\sigma}_{tt}}{q}. \tag{8.166}$$

Actually, the elastic solution of the problem indicates that the left hand side of this equation is

$$\lim_{t \rightarrow \infty} \frac{\sigma_{tt}}{q} = a \int_0^\infty \left\{ 2\nu J_0(r\xi) + (1 - 2\nu - z\xi) \frac{J_1(r\xi)}{r\xi} \right\} J_1(a\xi) \exp(-z\xi) d\xi. \tag{8.167}$$

It follows from equation (8.156) that the condition (8.166) would be satisfied if

$$\lim_{s \rightarrow 0} \frac{s S_{tt}}{a} = 2\nu \exp(-z\xi), \tag{8.168}$$

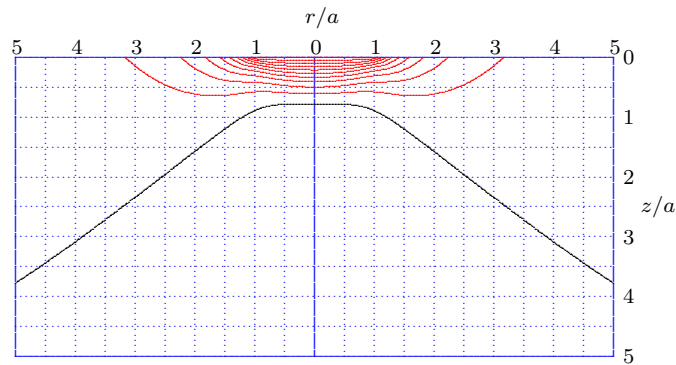

Figure 8.27: Disk load, Tangential stress.

and

$$\lim_{s \rightarrow 0} \frac{s t_{tt}}{a} = (1 - 2\nu - z\xi) \exp(-z\xi). \quad (8.169)$$

It can be verified from the solution of the consolidation problem, as expressed by equations (8.157) and (8.158), that the conditions (8.168) and (8.169) are indeed satisfied. It may be noted that the second condition is the inverse of the second condition in the case of the radial total stress.

PLANE STRAIN FINITE ELEMENTS

9.1 Introduction

In this chapter the finite element method for two-dimensional problems of poroelasticity is presented. The problems in this chapter are all for plane strain deformations, using cartesian coordinates x and y .

The finite element method was developed for the solution of problems of consolidation or poroelasticity around 1970, with contributions from many authors, see for instance Sandhu & Wilson (1969), Christian & Boehmer (1970), Booker (1973), Smith & Hobbs (1976), Smith (1977), Verruijt (1977), Zienkiewicz (1977), Bathe (1982).

The finite element equations are derived here using Galerkin's method of establishing approximate equations, and using quadrangular elements with isoparametric shape functions. For a derivation of the basic equations of the theory see Chapter 1.

9.2 Plane strain poroelasticity

In this section problems of plane strain poroelasticity will be considered, such as the problem illustrated in Figure 9.1, of a uniform load over a strip of width $2a$, on an elastic half space. The applied load varies with time, by a unit step function, indicating that the load is initially zero, is applied at time $t = 0$, and then remains constant.

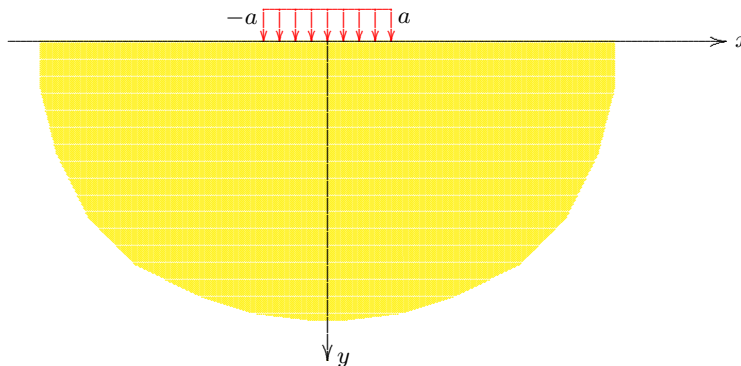

Figure 9.1: Strip on half space.

9.2.1 Basic equations

The first basic equation of plane strain poroelasticity is the fluid conservation equation (the storage equation). This equation can be written as

$$\alpha \frac{\partial e}{\partial t} + S \frac{\partial p}{\partial t} - \frac{\partial}{\partial x} \left(\frac{\kappa}{\mu} \frac{\partial p}{\partial x} \right) - \frac{\partial}{\partial y} \left(\frac{\kappa}{\mu} \frac{\partial p}{\partial y} \right) = 0, \quad (9.1)$$

where e is the volume strain of the solid material, p is the pressure in the fluid, κ is the permeability of the porous medium and μ is the viscosity of the fluid. The storage equation is based upon the principles of conservation of mass of the solids and the fluid, and Darcy's law for the flow of the fluid with respect to the solid material.

The parameter α , Biot's coefficient, is defined by

$$\alpha = 1 - C_s/C_m, \quad (9.2)$$

where C_s is the compressibility of the solid particles and C_m is the compressibility of the porous medium, the inverse of the compression modulus K of the soil, $C_m = 1/K$. For soft soils the compressibility of the particles C_s is much smaller than the compressibility of the porous medium C_m , so that Biot's coefficient is very close to 1, $\alpha \approx 1$.

The parameter S , the storativity, is defined as

$$S = nC_f + (\alpha - n)C_s, \quad (9.3)$$

where n is the porosity of the soil, and C_f is the compressibility of the pore fluid. Usually the compressibility of the fluid is also very small compared to the compressibility of the soil, but it is sometimes considered to include the compressibility of small amounts of air in the fluid. In that case the compressibility of the fluid may be larger, perhaps of the same order of magnitude as the compressibility of the soil.

Two more basic equations are the equations of equilibrium in two dimensions,

$$\frac{\partial \sigma_{xx}}{\partial x} + \frac{\partial \sigma_{yx}}{\partial y} - f_x = 0, \quad (9.4)$$

$$\frac{\partial \sigma_{xy}}{\partial x} + \frac{\partial \sigma_{yy}}{\partial y} - f_y = 0, \quad (9.5)$$

where f_x and f_y are the components of the body force, a force per unit volume. It may be noted that, to conform with most soil mechanics literature, compressive stresses are considered as positive, to be consistent with the usual sign convention for the pore pressures. This is in disagreement with the usual sign convention in applied mechanics, but is more convenient in soil mechanics. It should be noted that the body forces are considered positive in positive coordinate direction.

Furthermore, it is customary in the analysis of consolidation problems to consider only the incremental displacements and stresses, with respect to some initial state of equilibrium, at time $t = 0$. This initial state is assumed to incorporate the effect of gravity in the porous medium, both in the medium as a whole as in the fluid. This means that for the incremental stresses and displacements due to a given boundary load the body forces can often be assumed to vanish, except when additional body forces are applied after $t = 0$.

The stresses are composed of the effective stresses, which determine the deformations of the soil skeleton, and the pore pressure p , according to Terzaghi's principle, with Biot's correction,

$$\begin{aligned} \sigma_{xx} &= \sigma'_{xx} + \alpha p, \\ \sigma_{yy} &= \sigma'_{yy} + \alpha p, \\ \sigma_{xy} &= \sigma'_{xy}, \end{aligned} \quad (9.6)$$

where α is Biot's coefficient, defined in equation (9.2).

Substitution of equations (9.6) into equations (9.4) and (9.5) gives the equations of equilibrium expressed in terms of the effective stresses,

$$\frac{\partial \sigma'_{xx}}{\partial x} + \frac{\partial \sigma'_{yx}}{\partial y} + \frac{\partial(\alpha p)}{\partial x} - f_x = 0, \quad (9.7)$$

$$\frac{\partial \sigma'_{xy}}{\partial x} + \frac{\partial \sigma'_{yy}}{\partial y} + \frac{\partial(\alpha p)}{\partial y} - f_y = 0. \quad (9.8)$$

For an isotropic elastic material the effective stresses are related to the strain components by Hooke's law,

$$\begin{aligned} \sigma'_{xx} &= -(K - \frac{2}{3}G)e - 2G\varepsilon_{xx}, \\ \sigma'_{yy} &= -(K - \frac{2}{3}G)e - 2G\varepsilon_{yy}, \\ \sigma'_{xy} &= -2G\varepsilon_{xy}. \end{aligned} \quad (9.9)$$

In these equations K and G are the compression modulus and the shear modulus of the material, and e is the volume strain,

$$e = \varepsilon_{xx} + \varepsilon_{yy}. \quad (9.10)$$

The minus signs in equations (9.9) are a consequence of the unusual sign convention for the stresses, with compressive stresses being considered positive. As mentioned before, the compression modulus K is the inverse of the compressibility C_m of the soil,

$$K = 1/C_m. \quad (9.11)$$

The Lamé constants λ and μ , which are commonly used in elasticity theory, are related to the compression modulus K and the shear modulus G by the relations

$$\lambda = K - \frac{2}{3}G, \quad \mu = G. \quad (9.12)$$

From considerations of elementary continuum mechanics it follows that both K and G must be non-negative,

$$K \geq 0, \quad G \geq 0. \quad (9.13)$$

Although soils in engineering practice show considerable deviations from the linear isotropic elastic behaviour assumed above, this approximation will be used throughout this paper. If problems can be solved using this assumption, there may be some hope that problems for more complex material behaviour are solvable.

If it is supposed that the first order derivatives of the displacement components with respect to x and y are small compared to 1, the strain components ε_{xx} , ε_{yy} and ε_{xy} are related to the displacement components by the equations

$$\begin{aligned} \varepsilon_{xx} &= \frac{\partial u}{\partial x}, \\ \varepsilon_{yy} &= \frac{\partial v}{\partial y}, \\ \varepsilon_{xy} &= \frac{1}{2} \left(\frac{\partial u}{\partial y} + \frac{\partial v}{\partial x} \right). \end{aligned} \quad (9.14)$$

All the above equations must be satisfied throughout the domain occupied by the soil body.

Using equations (9.6), (9.9) and (9.14) the total stresses can be expressed into the displacements as

$$\begin{aligned} \sigma_{xx} &= -(K - \frac{2}{3}G)e - 2G \frac{\partial u}{\partial x} + \alpha p, \\ \sigma_{yy} &= -(K - \frac{2}{3}G)e - 2G \frac{\partial v}{\partial y} + \alpha p, \\ \sigma_{xy} &= -G \frac{\partial u}{\partial y} - G \frac{\partial v}{\partial x}. \end{aligned} \quad (9.15)$$

The equations of equilibrium, equations (9.7) and (9.8), can be expressed into the displacements as

$$\frac{\partial}{\partial x} [(K - \frac{2}{3}G)e] + \frac{\partial}{\partial x} [2G \frac{\partial u}{\partial x}] + \frac{\partial}{\partial y} [G \frac{\partial u}{\partial y} + G \frac{\partial v}{\partial x}] - \frac{\partial(\alpha p)}{\partial x} + f_x = 0, \quad (9.16)$$

$$\frac{\partial}{\partial y} [(K - \frac{2}{3}G)e] + \frac{\partial}{\partial y} [2G \frac{\partial v}{\partial y}] + \frac{\partial}{\partial x} [G \frac{\partial v}{\partial x} + G \frac{\partial u}{\partial y}] - \frac{\partial(\alpha p)}{\partial y} + f_y = 0. \quad (9.17)$$

The three equations (9.1), (9.16) and (9.17) are the basic equations of the theory of plane strain poroelasticity, expressed in the three basic variables: the two displacement components u and v , and the pore water pressure p .

It may be noted that for a homogeneous material, with K , G and α independent of x and y , these equations reduce to

$$(K + \frac{1}{3}G) \frac{\partial e}{\partial x} + G \left(\frac{\partial^2 u}{\partial x^2} + \frac{\partial^2 u}{\partial y^2} \right) - \alpha \frac{\partial p}{\partial x} + f_x = 0, \quad (9.18)$$

$$(K + \frac{1}{3}G) \frac{\partial e}{\partial y} + G \left(\frac{\partial^2 v}{\partial x^2} + \frac{\partial^2 v}{\partial y^2} \right) - \alpha \frac{\partial p}{\partial y} + f_y = 0. \quad (9.19)$$

In this form the equilibrium equations are particularly useful for the derivation of analytical solutions of consolidation problems. In this chapter, which is oriented towards the establishment of numerical solutions, the equations for a non-homogeneous material, (9.16) and (9.17), are used as the basic equations.

The boundary conditions of a problem are supposed to be that on one part of the boundary (S_1) the surface tractions are prescribed, and that on the remaining part (S_2) the displacements are prescribed. Formally this can be expressed as follows.

$$P \in S_1 : \begin{cases} \sigma_{nx} = \sigma_{xx}n_x + \sigma_{yx}n_y = -t_x, \\ \sigma_{ny} = \sigma_{xy}n_x + \sigma_{yy}n_y = -t_y. \end{cases} \quad (9.20)$$

and

$$P \in S_2 : \begin{cases} u = a, \\ v = b. \end{cases} \quad (9.21)$$

where S_1 and S_2 are disjoint parts of the boundary S , together forming the entire boundary. On S_1 the surface tractions t_x and t_y (positive in positive coordinate direction) are prescribed, and on S_2 the displacement components are prescribed, as a and b , respectively.

Boundary conditions should also be specified for the pore fluid. These are assumed to be that on one part of the boundary (S_3) the pore pressure is prescribed, and that on the remaining part of the boundary (S_4) the flux is prescribed,

$$P \in S_3 : p = h, \quad (9.22)$$

$$P \in S_4 : \frac{\kappa}{\mu} \frac{\partial p}{\partial n} = q, \quad (9.23)$$

where S_3 and S_4 are disjoint parts of the boundary S , together forming the entire boundary. On S_3 the pore pressure p is prescribed, as h , and on S_4 the flux supplied to the porous medium is prescribed, as the quantity q .

It is assumed without further investigation that the shape of the boundary and the nature of the boundary conditions ensure the existence of a unique solution of the problem defined by the equations (9.1) – (9.23). This may be the case only if the boundary conditions satisfy certain regularity conditions, such as global equilibrium and global continuity.

9.2.2 Time step

A convenient procedure of solving a consolidation problem numerically is to calculate the increment of the pore pressure p and the displacements u_i after a small time step Δt , assuming that these quantities are known at the beginning of this time step. The values at the end of the time step can then be considered as the initial values for the next step, and the process of consolidation can be analyzed step by step. The basic equations for this procedure can be obtained by integrating the basic equations presented in the previous section over a time step from $t = t_0$ to $t = t_0 + \Delta t$. For the storage equation (9.1) this gives

$$\alpha[e(t_0 + \Delta t) - e(t_0)] + S[p(t_0 + \Delta t) - p(t_0)] - \Delta t \left[\frac{\partial}{\partial x} \left(\frac{\kappa}{\mu} \frac{\partial \bar{p}}{\partial x} \right) + \frac{\partial}{\partial y} \left(\frac{\kappa}{\mu} \frac{\partial \bar{p}}{\partial y} \right) \right] = 0, \quad (9.24)$$

where \bar{p} is the average of the pore pressure during the time step,

$$\bar{p} = \frac{1}{\Delta t} \int_{t_0}^{t_0 + \Delta t} p \, dt. \quad (9.25)$$

It is now assumed that the average values of all quantities during a time step can be expressed in the values at the end and the beginning of the time step by formulas of the type

$$\bar{p} = (1 - \epsilon)p(t_0) + \epsilon p(t_0 + \Delta t), \quad (9.26)$$

where ϵ is an interpolation parameter. A value $\epsilon = 0$ indicates a forward finite difference approximation in time, and a value $\epsilon = 1$ indicates a backward finite difference approximation in time. It might be expected that the most accurate results are obtained if $\epsilon \approx 0.5$. The analogy with finite difference methods for diffusion type problems suggests that forward extrapolation may lead to unstable procedures, and can best be avoided. Thus it is suggested to take

$$0.5 \leq \epsilon \leq 1.0. \quad (9.27)$$

It has been shown (Booker & Small, 1974) that this will ensure that the numerical process is stable.

It follows from equation (9.26) that

$$p(t_0 + \Delta t) = p_0 + (\bar{p} - p_0)/\epsilon, \quad (9.28)$$

where $p_0 = p(t_0)$. Similarly, with $e_0 = e(t_0)$,

$$e(t_0 + \Delta t) = e_0 + (\bar{e} - e_0)/\epsilon. \quad (9.29)$$

Substitution of these expressions into equation (9.24) finally gives the storage equation in time averaged form as

$$\alpha(\bar{e} - e_0) + S(\bar{p} - p_0) - \epsilon\Delta t \left[\frac{\partial}{\partial x} \left(\frac{\kappa}{\mu} \frac{\partial \bar{p}}{\partial x} \right) + \frac{\partial}{\partial y} \left(\frac{\kappa}{\mu} \frac{\partial \bar{p}}{\partial y} \right) \right] = 0. \quad (9.30)$$

The time averaged form of the equations of equilibrium (9.4) and (9.5) is

$$\frac{\partial \bar{\sigma}_{xx}}{\partial x} + \frac{\partial \bar{\sigma}_{yx}}{\partial y} - \bar{f}_x = 0, \quad (9.31)$$

$$\frac{\partial \bar{\sigma}_{xy}}{\partial x} + \frac{\partial \bar{\sigma}_{yy}}{\partial y} - \bar{f}_y = 0, \quad (9.32)$$

where \bar{f}_x and \bar{f}_y are the averaged values of the body force in the time step considered. They are defined by expressions similar to equation (9.26),

$$\bar{f}_x = (1 - \epsilon)f_x(t_0) + \epsilon f_x(t_0 + \Delta t), \quad (9.33)$$

$$\bar{f}_y = (1 - \epsilon)f_y(t_0) + \epsilon f_y(t_0 + \Delta t). \quad (9.34)$$

The time averaged stresses are related to the time averaged displacements and the time averaged pore pressure by relations equivalent to equations (9.6) and (9.9).

The averaged quantities should satisfy the averaged forms of the boundary conditions

$$P \in S_1 : \begin{cases} \bar{\sigma}_{nx} = \bar{\sigma}_{xx}n_x + \bar{\sigma}_{yx}n_y = -\bar{t}_x, \\ \bar{\sigma}_{ny} = \bar{\sigma}_{xy}n_x + \bar{\sigma}_{yy}n_y = -\bar{t}_y. \end{cases} \quad (9.35)$$

$$P \in S_2 : \begin{cases} \bar{u} = \bar{a}, \\ \bar{v} = \bar{b}, \end{cases} \quad (9.36)$$

$$P \in S_3 : \bar{p} = \bar{h}, \quad (9.37)$$

$$P \in S_4 : \frac{\kappa}{\mu} \frac{\partial \bar{p}}{\partial n} = \bar{q}. \quad (9.38)$$

Backward interpolation

The basic equations are somewhat simpler if the interpolation parameter ϵ is assumed to be $\epsilon = 1$, indicating backward interpolation. Experience has shown that this usually leads to sufficiently accurate results. This simplified version of the equations is assumed to apply in the sequel of this chapter.

Equation (9.30) now becomes

$$\alpha(e_1 - e_0) + S(p_1 - p_0) - \epsilon\Delta t \left[\frac{\partial}{\partial x} \left(\frac{\kappa}{\mu} \frac{\partial p_1}{\partial x} \right) + \frac{\partial}{\partial y} \left(\frac{\kappa}{\mu} \frac{\partial p_1}{\partial y} \right) \right] = 0. \quad (9.39)$$

where p_1 is the pressure at the end of the first time step,

$$p_1 = p(t_0 + \Delta t), \quad (9.40)$$

and e_1 is the volume strain at the end of this step.

For all other variables the average values reduce to the values at time $t = t_0 + \Delta t$.

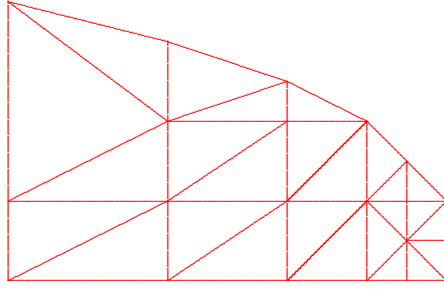

Figure 9.2: Mesh of triangular elements.

9.2.3 The Galerkin method

There are various methods to develop numerical methods for the approximate solution of the equations presented in the previous section. A powerful method is the finite element method, in which the region occupied by the body is subdivided into a large number of small elements, and the numerical equations are obtained by assuming a certain simplified variation of the basic variables (the displacements) in each element. Simple elements that are often used are triangles, see figure 9.2, or quadrangles.

It is assumed that the basic parameters, the displacement components u and v , and the pore pressure p can be approximated by

$$u = \sum_{i=1}^n N_i(x, y)u_i, \quad v = \sum_{i=1}^n N_i(x, y)v_i, \quad p = \sum_{i=1}^n N_i(x, y)p_i, \quad (9.41)$$

where n is the number of nodes in the mesh of finite elements, and u_i , v_i and p_i are the values of the parameters at the end of a time step at node i . The functions $N_i(x, y)$ are shape functions. They will be specified later. It follows from the first two of equations (9.41) that the volume strain e now is

$$e = \frac{\partial u}{\partial x} + \frac{\partial v}{\partial y} = \sum_{i=1}^n \left(\frac{\partial N_i}{\partial x} u_i + \frac{\partial N_i}{\partial y} v_i \right). \quad (9.42)$$

The effective stresses are, with equations (9.9) and (9.14),

$$\begin{aligned} \sigma'_{xx} &= -(K + \frac{4}{3}G) \sum_{i=1}^n \frac{\partial N_i}{\partial x} u_i - (K - \frac{2}{3}G) \sum_{i=1}^n \frac{\partial N_i}{\partial y} v_i, \\ \sigma'_{yy} &= -(K + \frac{4}{3}G) \sum_{i=1}^n \frac{\partial N_i}{\partial y} v_i - (K - \frac{2}{3}G) \sum_{i=1}^n \frac{\partial N_i}{\partial x} u_i, \\ \sigma'_{yx} &= -G \sum_{i=1}^n \frac{\partial N_i}{\partial y} u_i - G \sum_{i=1}^n \frac{\partial N_i}{\partial x} v_i. \end{aligned} \quad (9.43)$$

The total stresses are, with equations (9.6),

$$\begin{aligned} \sigma_{xx} &= -(K + \frac{4}{3}G) \sum_{i=1}^n \frac{\partial N_i}{\partial x} u_i - (K - \frac{2}{3}G) \sum_{i=1}^n \frac{\partial N_i}{\partial y} v_i + \alpha \sum_{i=1}^n N_i p_i, \\ \sigma_{yy} &= -(K + \frac{4}{3}G) \sum_{i=1}^n \frac{\partial N_i}{\partial y} v_i - (K - \frac{2}{3}G) \sum_{i=1}^n \frac{\partial N_i}{\partial x} u_i + \alpha \sum_{i=1}^n N_i p_i, \\ \sigma_{yx} &= -G \sum_{i=1}^n \frac{\partial N_i}{\partial y} u_i - G \sum_{i=1}^n \frac{\partial N_i}{\partial x} v_i. \end{aligned} \quad (9.44)$$

The basic differential equations cannot be satisfied identically by the approximations (9.41). A good approximation can probably be obtained, however, by requiring that the equations are satisfied on the (spatial) average, using appropriate weight functions. In the Galerkin method the weight functions are chosen in the form of the shape functions $N_i(x, y)$. The three equations will be elaborated successively, starting with the equilibrium equations, because these are very similar to the equilibrium equations in elasticity, so that the analysis can be copied from an elastic analysis, the only difference being the additional term representing the pressure gradient.

Equilibrium in x -direction

The incremental form of the equation of equilibrium in x -direction, equation (9.31), can be satisfied on the average by requiring that

$$\iint_R \left[\frac{\partial \sigma_{xx}}{\partial x} + \frac{\partial \sigma_{yx}}{\partial y} - f_x \right] N_i dx dy = 0. \quad (9.45)$$

This equation should be satisfied for all values of $i = 1, \dots, n$, with the exception of the values of i for which the boundary displacement u_i is prescribed.

Because

$$\left[\frac{\partial \sigma_{xx}}{\partial x} + \frac{\partial \sigma_{yx}}{\partial y} \right] N_i = \frac{\partial}{\partial x} [\sigma_{xx} N_i] + \frac{\partial}{\partial y} [\sigma_{yx} N_i] - \sigma_{xx} \frac{\partial N_i}{\partial x} - \sigma_{yx} \frac{\partial N_i}{\partial y}, \quad (9.46)$$

equation (9.45) can be written as

$$X_1 + X_2 + X_3 = 0, \quad (9.47)$$

where

$$X_1 = \iint_R \left\{ \frac{\partial}{\partial x} [\sigma_{xx} N_i] + \frac{\partial}{\partial y} [\sigma_{yx} N_i] \right\} dx dy, \quad (9.48)$$

$$X_2 = - \iint_R \left\{ \sigma_{xx} \frac{\partial N_i}{\partial x} + \sigma_{yx} \frac{\partial N_i}{\partial y} \right\} dx dy, \quad (9.49)$$

$$X_3 = - \iint_R \bar{f}_x N_i dx dy. \quad (9.50)$$

Each of these integrals will be elaborated separately.

The first integral, X_1 , can be transformed into a surface integral by Gauss' divergence theorem. This gives, with the first of equations (9.35),

$$X_1 = \int_S \sigma_{nx} N_i dS = - \sum \frac{1}{2} t_x L, \quad (9.51)$$

where t_x is the surface stress σ_{nx} on an element side on the boundary S (a boundary segment), and L is the length of that boundary segment. The summation is over all element sides along the boundary which contain node i , and in which the displacement is not prescribed by a boundary condition. Because values of i on the boundary S_2 do not apply, only boundary segments on S_1 occur in equation (9.51), on which t_x is given. The factor $\frac{1}{2}$ occurs because the average value of the shape function N_i over a boundary segment containing node i is assumed to be $\frac{1}{2}$. It seems appropriate that the total force on a boundary segment is distributed homogeneously over its two nodes.

The second integral, X_2 , can be elaborated by substituting two of the expressions (9.44) for the total stresses into equation (9.49). This gives

$$X_2 = \iint_R \sum_{j=1}^n \left\{ \left(K + \frac{4}{3} G \right) \frac{\partial N_i}{\partial x} \frac{\partial N_j}{\partial x} u_j + \left(K - \frac{2}{3} G \right) \frac{\partial N_i}{\partial x} \frac{\partial N_j}{\partial y} v_j + G \frac{\partial N_i}{\partial y} \frac{\partial N_j}{\partial y} u_j + G \frac{\partial N_i}{\partial y} \frac{\partial N_j}{\partial x} v_j - \alpha \frac{\partial N_i}{\partial x} N_j p_j \right\} dx dy. \quad (9.52)$$

The integral is over the entire area R , which can be considered as the sum of all elements,

$$R = \sum_{l=1}^m R_l, \quad (9.53)$$

where R_l is a typical element, and m is the number of elements.

The integral (9.52) can now be written as

$$X_2 = \sum_{l=1}^m \sum_{j=1}^n (P_{ijl} u_j + Q_{ijl} v_j + S_{ijl} p_j), \quad (9.54)$$

where now

$$P_{ijl} = (K_l + \frac{4}{3}G_l) \iint_{R_l} \frac{\partial N_i}{\partial x} \frac{\partial N_j}{\partial x} dx dy + G_l \iint_{R_l} \frac{\partial N_i}{\partial y} \frac{\partial N_j}{\partial y} dx dy, \quad (9.55)$$

$$Q_{ijl} = (K_l - \frac{2}{3}G_l) \iint_{R_l} \frac{\partial N_i}{\partial x} \frac{\partial N_j}{\partial y} dx dy + G_l \iint_{R_l} \frac{\partial N_i}{\partial y} \frac{\partial N_j}{\partial x} dx dy, \quad (9.56)$$

$$S_{ijl} = -\alpha_l \iint_{R_l} \frac{\partial N_i}{\partial x} N_j dx dy. \quad (9.57)$$

It has been assumed that the material properties are constant in element l , and denoted by K_l , G_l and α_l . It is one of the important characteristics of the finite element method that the material properties may be different in each element, and that no further considerations are needed to satisfy equilibrium and fluid continuity at an interface.

The third integral, X_3 , consists of an integral of the body force f_x over the region R , multiplied by the shape function N_i , see equation (9.50). Only the elements which contain node i contribute to this integral, and for such elements the average value of the shape function is assumed to be $1/k$, where k is the number of nodes per element (for instance 3 or 4). Thus the integral consists of elementary contributions of the form

$$X_3 = -F_x^i = -\sum_{l=1}^m \frac{A_l f_x}{k}, \quad (9.58)$$

where A_l is the area of element l . The body force multiplied by the area of the element represents the total force exerted upon the element by the body forces in that element. Assuming that there is no bias in the shape functions, each node carries an equal share of the total body force in an element.

Equilibrium in y -direction

The equation of equilibrium in y -direction, equation (9.32), can be satisfied on the average by requiring that

$$\iint_R \left[\frac{\partial \sigma_{xy}}{\partial x} + \frac{\partial \sigma_{yy}}{\partial y} - f_y \right] N_i dx dy = 0. \quad (9.59)$$

This equation should be satisfied for all values of $i = 1, \dots, n$, with the exception of the values of i for which the boundary displacement v_i is prescribed.

Because

$$\left[\frac{\partial \sigma_{xy}}{\partial x} + \frac{\partial \sigma_{yy}}{\partial y} \right] N_i = \frac{\partial}{\partial x} [\sigma_{xy} N_i] + \frac{\partial}{\partial y} [\sigma_{yy} N_i] - \sigma_{xy} \frac{\partial N_i}{\partial x} - \sigma_{yy} \frac{\partial N_i}{\partial y}, \quad (9.60)$$

equation (9.59) can be written as

$$Y_1 + Y_2 + Y_3 = 0, \quad (9.61)$$

where

$$Y_1 = \iint_R \left\{ \frac{\partial}{\partial x} [\sigma_{xy} N_i] + \frac{\partial}{\partial y} [\sigma_{yy} N_i] \right\} dx dy, \quad (9.62)$$

$$Y_2 = -\iint_R \left\{ \sigma_{xy} \frac{\partial N_i}{\partial x} + \sigma_{yy} \frac{\partial N_i}{\partial y} \right\} dx dy, \quad (9.63)$$

$$Y_3 = - \iint_R f_y N_i dx dy. \quad (9.64)$$

Each of these integrals will be elaborated separately.

The first integral, Y_1 , can be transformed into a surface integral by Gauss' divergence theorem. This gives, with the second of equations (9.35),

$$Y_1 = \int_S \sigma_{ny} N_i dS = - \sum \frac{1}{2} t_y L, \quad (9.65)$$

where t_y is the surface stress σ_{ny} on an element side on the boundary S (a boundary segment), and L is the length of that boundary segment. The summation is over all element sides along the boundary which contain node i , and in which the displacement is not prescribed by a boundary condition. Because values of i on the boundary S_2 do not apply, only boundary segments on S_1 occur in equation (9.65), on which t_y is given. The factor $\frac{1}{2}$ occurs because the average value of the shape function N_i over a boundary segment containing node i is assumed to be $\frac{1}{2}$.

The second integral, Y_2 , can be elaborated by substituting two of the expressions (9.44) for the total stresses into equation (9.63). This gives

$$Y_2 = \iint_R \sum_{j=1}^n \left\{ (K + \frac{4}{3}G) \frac{\partial N_i}{\partial y} \frac{\partial N_j}{\partial y} v_j + (K - \frac{2}{3}G) \frac{\partial N_i}{\partial y} \frac{\partial N_j}{\partial x} u_j + G \frac{\partial N_i}{\partial x} \frac{\partial N_j}{\partial x} v_j + G \frac{\partial N_i}{\partial x} \frac{\partial N_j}{\partial y} u_j - \alpha \frac{\partial N_i}{\partial y} N_j p_j \right\} dx dy. \quad (9.66)$$

The integral is over the entire area R , which can be considered as the sum of all elements, see equation (9.53). The integral (9.66) can now be written as

$$Y_2 = \sum_{p=1}^m \sum_{j=1}^n (Q_{jil} u_j + R_{ijl} v_j + T_{ijl} p_j), \quad (9.67)$$

where

$$Q_{jil} = (K_l - \frac{2}{3}G_l) \iint_{R_l} \frac{\partial N_j}{\partial x} \frac{\partial N_i}{\partial y} dx dy + G_l \iint_{R_l} \frac{\partial N_j}{\partial y} \frac{\partial N_i}{\partial x} dx dy, \quad (9.68)$$

$$R_{ijl} = (K_l + \frac{4}{3}G_l) \iint_{R_l} \frac{\partial N_i}{\partial y} \frac{\partial N_j}{\partial y} dx dy + G_l \iint_{R_l} \frac{\partial N_i}{\partial x} \frac{\partial N_j}{\partial x} dx dy, \quad (9.69)$$

$$T_{ijl} = -\alpha_l \iint_{R_l} \frac{\partial N_i}{\partial y} N_j dx dy. \quad (9.70)$$

It may be noted that the expressions (9.56) and (9.68) for Q_{ijl} are equal. This is a consequence of the symmetry of the equations of equilibrium.

The third integral, Y_3 , consists of an integral of the body force f_y over the region R , multiplied by the shape function N_i , see equation (9.64). Only the elements which contain node i contribute to this integral, and for such elements the average value of the shape function is assumed to be $1/k$, where k is the number of nodes per element (for instance 3 or 4). Thus the integral consists of elementary contributions of the form

$$Y_3 = -F_y^i = - \sum_{l=1}^m \frac{A_l f_y}{k}, \quad (9.71)$$

where A_l is the area of element l .

The storage equation

The storage equation (9.39) can be satisfied on the spatial average by requiring that

$$\iint_R \left\{ \alpha (e - e_0) + S (p - p_0) - \Delta t \left[\frac{\partial}{\partial x} \left(\frac{\kappa}{\mu} \frac{\partial p}{\partial x} \right) + \frac{\partial}{\partial y} \left(\frac{\kappa}{\mu} \frac{\partial p}{\partial y} \right) \right] \right\} N_i \, dx \, dy = 0. \quad (9.72)$$

This equation must be satisfied for all values of i for which the pressure p_i is not prescribed by a boundary condition.

The first two terms of equation (9.72) can be elaborated to

$$\iint_R [\alpha (e - e_0) + S (p - p_0)] N_i \, dx \, dy = \sum_{l=1}^m \sum_{j=1}^n [V_{ijl} (u_j - u_{0j}) + W_{ijl} (v_j - v_{0j}) + C_{ijl} (p_j - p_{0j})], \quad (9.73)$$

where

$$V_{ijl} = \alpha_l \iint_{R_l} \frac{\partial N_j}{\partial x} N_i \, dx \, dy, \quad (9.74)$$

$$W_{ijl} = \alpha_l \iint_{R_l} \frac{\partial N_j}{\partial y} N_i \, dx \, dy, \quad (9.75)$$

$$C_{ijl} = S_l \iint_{R_l} N_i N_j \, dx \, dy. \quad (9.76)$$

It may be noted, by comparison with equations (9.57) and (9.70) that

$$V_{ijl} = -S_{jil}, \quad (9.77)$$

$$W_{ijl} = -T_{jil}. \quad (9.78)$$

In the third and the fourth term of equation (9.72) the following identity may be used,

$$\left[\frac{\partial}{\partial x} \left(\frac{\kappa}{\mu} \frac{\partial p}{\partial x} \right) + \frac{\partial}{\partial y} \left(\frac{\kappa}{\mu} \frac{\partial p}{\partial y} \right) \right] N_i = \frac{\partial}{\partial x} \left(\frac{\kappa}{\mu} \frac{\partial p}{\partial x} N_i \right) + \frac{\partial}{\partial y} \left(\frac{\kappa}{\mu} \frac{\partial p}{\partial y} N_i \right) - \frac{\kappa}{\mu} \frac{\partial p}{\partial x} \frac{\partial N_i}{\partial x} - \frac{\kappa}{\mu} \frac{\partial p}{\partial y} \frac{\partial N_i}{\partial y}. \quad (9.79)$$

It follows that

$$- \iint_R \left\{ \Delta t \left[\frac{\partial}{\partial x} \left(\frac{\kappa}{\mu} \frac{\partial p}{\partial x} \right) + \frac{\partial}{\partial y} \left(\frac{\kappa}{\mu} \frac{\partial p}{\partial y} \right) \right] \right\} N_i \, dx \, dy = -\Delta t \sum_{S_4} \frac{1}{2} qL + \Delta t \sum_{l=1}^m \sum_{j=1}^n D_{ijl} p_j, \quad (9.80)$$

where the first summation in the right hand side is over all boundary elements where the flux is prescribed, and where

$$D_{ijl} = \frac{\kappa_l}{\mu_l} \iint_{R_l} \left(\frac{\partial N_i}{\partial x} \frac{\partial N_j}{\partial x} + \frac{\partial N_i}{\partial y} \frac{\partial N_j}{\partial y} \right) \, dx \, dy. \quad (9.81)$$

It follows that the numerical form of the storage equation (9.72) is

$$\begin{aligned} & \iint_R \left\{ \alpha (e - e_0) + S (p - p_0) - \Delta t \left[\frac{\partial}{\partial x} \left(\frac{\kappa}{\mu} \frac{\partial p}{\partial x} \right) + \frac{\partial}{\partial y} \left(\frac{\kappa}{\mu} \frac{\partial p}{\partial y} \right) \right] \right\} N_i \, dx \, dy = \\ & \sum_{l=1}^m \sum_{j=1}^n [V_{ijl} (u_j - u_{0j}) + W_{ijl} (v_j - v_{0j}) + C_{ijl} (p_j - p_{0j})] - \Delta t \sum_{S_4} \frac{1}{2} qL + \Delta t \sum_{l=1}^m \sum_{j=1}^n D_{ijl} p_j = 0. \end{aligned} \quad (9.82)$$

The system of equations

By adding the expressions found for X_1 , X_2 and X_3 , see (9.51), (9.54) and (9.58), the equation of horizontal equilibrium can be expressed as

$$\sum_{j=1}^n P_{ij}u_j + \sum_{j=1}^n Q_{ij}v_j + \sum_{j=1}^n S_{ij}p_j = F_{xi}, \quad (9.83)$$

where F_{xi} represents the total force in x -direction acting upon node i , either from a stress along the boundary, or from a body force. The matrices P_{ij} , Q_{ij} and S_{ij} are composed of a summation of the submatrices P_{ijl} , Q_{ijl} and S_{ijl} , defined in equations (9.55), (9.56) and (9.57).

The second equation is the equation of vertical equilibrium, which can be obtained by adding the expressions found for Y_1 , Y_2 and Y_3 , see (9.65), (9.67) and (9.71),

$$\sum_{j=1}^n Q_{ji}u_j + \sum_{j=1}^n R_{ij}v_j + \sum_{j=1}^n T_{ij}p_j = F_{yi}, \quad (9.84)$$

where F_{yi} is the total force in y -direction acting upon node i , either from a stress along the boundary, or from a body force. The matrices Q_{ij} , R_{ij} and T_{ij} are composed of a summation of the submatrices Q_{ijl} , R_{ijl} and T_{ijl} , defined in equations (9.56), (9.69) and (9.70).

The third equation is the storage equation, which has been given in equation (9.82). This equation can be rewritten as

$$\sum_{j=1}^n V_{ij}u_j + \sum_{j=1}^n W_{ij}v_j + \sum_{j=1}^n U_{ij}p_j = QQ_i, \quad (9.85)$$

where U_{ij} consists of contributions from all elements of the form

$$U_{ijl} = C_{ijl} + D_{ijl}\Delta t, \quad (9.86)$$

and QQ_i is composed of contributions from all elements of the form

$$QQ_{il} = \sum_{j=1}^n V_{ij}u_{0j} + \sum_{j=1}^n W_{ij}v_{0j} + \sum_{j=1}^n C_{ij}p_{0j} - \frac{1}{2}\bar{q}_l L_l \Delta t. \quad (9.87)$$

The equations (9.83), (9.84) and (9.85) constitute a system of $3n$ equations with $3n$ variables. This system can be solved by a suitable method for solving systems of linear algebraic equations, for instance Gaussian elimination or the conjugate gradient method. It must be noted that the system is ill-conditioned, especially if the pore fluid is practically incompressible and the time step is small. In that case the coefficient of p_i in equation (9.85), which is a coefficient on the main diagonal of the system matrix, is practically zero. The solution of the system of equations requires an advanced numerical solution method, such as Bi-CGSTAB (Van der Vorst, 1992), with a suitable preconditioner.

It may also be noted that the boundary conditions for the displacements and the pore pressure have been practically ignored so far. These can easily be incorporated, however, by replacing the equations from the system of equations (9.83), (9.84) and (9.85) by equations of the type

$$i \in S_2 : \begin{cases} u_i = a_i, \\ v_i = b_i, \end{cases} \quad (9.88)$$

or

$$i \in S_3 : p_i = h_i, \quad (9.89)$$

where a_i and b_i are the given values of the displacement in a node located on the boundary S_2 , and h_i is the given value of the pore pressure in a node located on the boundary S_3 .

If the system of equations (9.83), (9.84) and (9.85) has been solved, the values of the displacements and the pore pressure after the time step have been determined. These values can be considered as the initial values for the next time step, and the process can be repeated for any number of time steps.

9.2.4 Isoparametric elements

In this section the basic equations will be elaborated for a particular type of elements: quadrangular elements, with isoparametric shape functions.

A typical quadrangular element in the x, y -plane is shown in Figure 9.3. The basic idea of isoparametric shape functions is to use a local coordinate system ξ, η , with $-1 \leq \xi \leq +1$ and $-1 \leq \eta \leq +1$. The local

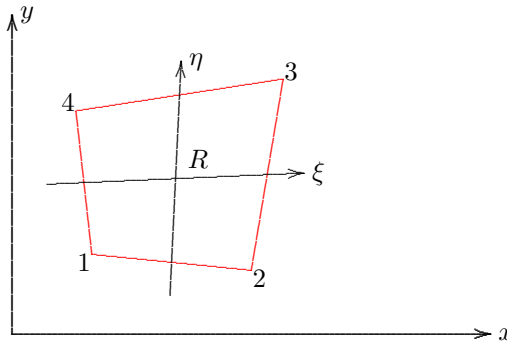

Figure 9.3: Isoparametric element.

coordinates of the four points are, for point 1 : $\xi = -1, \eta = -1$, for point 2 : $\xi = 1, \eta = -1$, for point 3 : $\xi = 1, \eta = 1$, and for point 4 : $\xi = -1, \eta = 1$.

The global coordinates x and y are interpolated in the element as

$$x = \sum_{k=1}^4 N_k x_k, \quad y = \sum_{k=1}^4 N_k y_k, \quad (9.90)$$

where

$$\begin{aligned} N_1 &= \frac{1}{4}(1 - \xi)(1 - \eta), \\ N_2 &= \frac{1}{4}(1 + \xi)(1 - \eta), \\ N_3 &= \frac{1}{4}(1 + \xi)(1 + \eta), \\ N_4 &= \frac{1}{4}(1 - \xi)(1 + \eta). \end{aligned} \quad (9.91)$$

It can immediately be seen that these equations ensure that the coordinates in node i indeed are x_i and y_i . Similarly the displacements u and v and the pore pressure p are interpolated as

$$u = \sum_{k=1}^4 N_k u_k, \quad v = \sum_{k=1}^4 N_k v_k, \quad p = \sum_{k=1}^4 N_k p_k, \quad (9.92)$$

where u_k, v_k and p_k are the values of the displacement components and the pore pressure in node k .

In the finite element method integrals of the products of N_i and N_j , or their derivatives, over an area in the x, y -plane have to be evaluated. In order to transform these integrals into integrals in the ξ, η -plane a transformation from the coordinates x and y to ξ and η must be effected. The transformation of derivatives is given by

$$\begin{vmatrix} \frac{\partial}{\partial \xi} \\ \frac{\partial}{\partial \eta} \end{vmatrix} = \begin{vmatrix} \frac{\partial x}{\partial \xi} & \frac{\partial y}{\partial \xi} \\ \frac{\partial x}{\partial \eta} & \frac{\partial y}{\partial \eta} \end{vmatrix} \begin{vmatrix} \frac{\partial}{\partial x} \\ \frac{\partial}{\partial y} \end{vmatrix}, \quad (9.93)$$

or, using matrix notation,

$$\frac{\partial}{\partial \mathbf{r}} = \mathbf{J} \frac{\partial}{\partial \mathbf{x}}, \quad (9.94)$$

where \mathbf{J} is the transformation matrix

$$\mathbf{J} = \begin{vmatrix} \frac{\partial x}{\partial \xi} & \frac{\partial y}{\partial \xi} \\ \frac{\partial x}{\partial \eta} & \frac{\partial y}{\partial \eta} \end{vmatrix}. \quad (9.95)$$

It should be noted that the coefficients of this matrix are not constants, because the relationship between x, y and ξ, η is non-linear, so that the coefficients of the transformation matrix are functions of ξ and η . In the point $\xi = \xi_i, \eta = \eta_j$ we will write

$$\mathbf{J}_{ij} = \begin{vmatrix} \frac{\partial x}{\partial \xi} & \frac{\partial y}{\partial \xi} \\ \frac{\partial x}{\partial \eta} & \frac{\partial y}{\partial \eta} \end{vmatrix}_{\xi=\xi_i, \eta=\eta_j}. \quad (9.96)$$

The actual values of the coefficients of the transformation matrix are, using the definitions (9.90) and (9.91),

$$\begin{aligned} \frac{\partial x}{\partial \xi} &= -\frac{1}{4}(1-\eta)x_1 + \frac{1}{4}(1-\eta)x_2 + \frac{1}{4}(1+\eta)x_3 - \frac{1}{4}(1+\eta)x_4, \\ \frac{\partial y}{\partial \xi} &= -\frac{1}{4}(1-\eta)y_1 + \frac{1}{4}(1-\eta)y_2 + \frac{1}{4}(1+\eta)y_3 - \frac{1}{4}(1+\eta)y_4, \\ \frac{\partial x}{\partial \eta} &= -\frac{1}{4}(1-\xi)x_1 - \frac{1}{4}(1+\xi)x_2 + \frac{1}{4}(1+\xi)x_3 + \frac{1}{4}(1-\xi)x_4, \\ \frac{\partial y}{\partial \eta} &= -\frac{1}{4}(1-\xi)y_1 - \frac{1}{4}(1+\xi)y_2 + \frac{1}{4}(1+\xi)y_3 + \frac{1}{4}(1-\xi)y_4. \end{aligned} \quad (9.97)$$

These values can easily be calculated in any arbitrary point ξ, η . Thus the matrix \mathbf{J}_{ij} is known in every point ξ, η . Its inverse is denoted by \mathbf{J}_{ij}^{-1} , and it is defined by

$$\mathbf{J}_{ij}\mathbf{J}_{ij}^{-1} = \mathbf{I} = \begin{vmatrix} 1 & 0 \\ 0 & 1 \end{vmatrix}. \quad (9.98)$$

The coefficients of the inverse matrix can also be calculated easily, in any point ξ, η ,

$$\mathbf{J}_{ij}^{-1} = \frac{1}{\det(\mathbf{J}_{ij})} \begin{vmatrix} \frac{\partial y}{\partial \eta} & -\frac{\partial y}{\partial \xi} \\ -\frac{\partial x}{\partial \eta} & \frac{\partial x}{\partial \xi} \end{vmatrix}_{\xi=\xi_i, \eta=\eta_j}, \quad (9.99)$$

where $\det(\mathbf{J}_{ij})$ is the determinant of the matrix,

$$\det(\mathbf{J}_{ij}) = \frac{\partial x}{\partial \xi} \frac{\partial y}{\partial \eta} - \frac{\partial y}{\partial \xi} \frac{\partial x}{\partial \eta}. \quad (9.100)$$

The inverse matrix can also be defined as the relation inverse to equation (9.93),

$$\begin{vmatrix} \frac{\partial}{\partial x} \\ \frac{\partial}{\partial y} \end{vmatrix} = \begin{vmatrix} \frac{\partial \xi}{\partial x} & \frac{\partial \eta}{\partial x} \\ \frac{\partial \xi}{\partial y} & \frac{\partial \eta}{\partial y} \end{vmatrix} \begin{vmatrix} \frac{\partial}{\partial \xi} \\ \frac{\partial}{\partial \eta} \end{vmatrix}, \quad (9.101)$$

or, using matrix notation,

$$\frac{\partial}{\partial \mathbf{x}} = \mathbf{J}^{-1} \frac{\partial}{\partial \mathbf{r}}, \quad (9.102)$$

where now \mathbf{J}^{-1} is the inverse transformation matrix

$$\mathbf{J}^{-1} = \begin{vmatrix} \frac{\partial \xi}{\partial x} & \frac{\partial \eta}{\partial x} \\ \frac{\partial \xi}{\partial y} & \frac{\partial \eta}{\partial y} \end{vmatrix}. \quad (9.103)$$

The derivatives of the shape functions can be calculated using the following relations

$$\frac{\partial N_i}{\partial x} = \frac{\partial N_i}{\partial \xi} \frac{\partial \xi}{\partial x} + \frac{\partial N_i}{\partial \eta} \frac{\partial \eta}{\partial x} = J_{11}^{-1} \frac{\partial N_i}{\partial \xi} + J_{12}^{-1} \frac{\partial N_i}{\partial \eta}, \quad (9.104)$$

$$\frac{\partial N_i}{\partial y} = \frac{\partial N_i}{\partial \xi} \frac{\partial \xi}{\partial y} + \frac{\partial N_i}{\partial \eta} \frac{\partial \eta}{\partial y} = J_{21}^{-1} \frac{\partial N_i}{\partial \xi} + J_{22}^{-1} \frac{\partial N_i}{\partial \eta}. \quad (9.105)$$

In these expressions the derivatives $\partial N_i/\partial \xi$ and $\partial N_i/\partial \eta$ can easily be calculated from the definitions (9.91). The coefficients of the matrix \mathbf{J}^{-1} can most easily be determined from equation (9.99).

The integrals needed to calculate the coefficients in the finite element equations can now be expressed into integrals over ξ and η as

$$p_{ij}^1 = \iint_{R_i} \frac{\partial N_i}{\partial x} \frac{\partial N_j}{\partial x} dx dy = \iint_{R_i} \frac{\partial N_i}{\partial x} \frac{\partial N_j}{\partial x} \det(\mathbf{J}_{ij}) d\xi d\eta, \quad (9.106)$$

$$p_{ij}^2 = \iint_{R_i} \frac{\partial N_i}{\partial y} \frac{\partial N_j}{\partial y} dx dy = \iint_{R_i} \frac{\partial N_i}{\partial y} \frac{\partial N_j}{\partial y} \det(\mathbf{J}_{ij}) d\xi d\eta, \quad (9.107)$$

$$q_{ij}^1 = \iint_{R_i} \frac{\partial N_i}{\partial x} \frac{\partial N_j}{\partial y} dx dy = \iint_{R_i} \frac{\partial N_i}{\partial x} \frac{\partial N_j}{\partial y} \det(\mathbf{J}_{ij}) d\xi d\eta, \quad (9.108)$$

$$q_{ij}^2 = \iint_{R_i} \frac{\partial N_i}{\partial y} \frac{\partial N_j}{\partial x} dx dy = \iint_{R_i} \frac{\partial N_i}{\partial y} \frac{\partial N_j}{\partial x} \det(\mathbf{J}_{ij}) d\xi d\eta, \quad (9.109)$$

$$s_{ij}^1 = \iint_{R_i} \frac{\partial N_i}{\partial x} N_j dx dy = \iint_{R_i} \frac{\partial N_i}{\partial x} N_j \det(\mathbf{J}_{ij}) d\xi d\eta, \quad (9.110)$$

$$t_{ij}^1 = \iint_{R_i} \frac{\partial N_i}{\partial y} N_j dx dy = \iint_{R_i} \frac{\partial N_i}{\partial y} N_j \det(\mathbf{J}_{ij}) d\xi d\eta, \quad (9.111)$$

$$c_{ij}^1 = \iint_{R_i} N_i N_j dx dy = \iint_{R_i} N_i N_j \det(\mathbf{J}_{ij}) d\xi d\eta. \quad (9.112)$$

$$d_{ij}^1 = p_{ij}^1 + p_{ij}^2. \quad (9.113)$$

These integrals can be calculated numerically by adding the values in the four Gaussian points $\xi = \pm a, \eta = \pm a$, where $a = 1/\sqrt{3} = 0.5773503$.

Using the expressions (9.106)–(9.113) the submatrices needed to determine the system of equations can be written as

$$P_{ijl} = (K_l + \frac{4}{3}G_l)p_{ij}^1 + G_l p_{ij}^2, \quad (9.114)$$

$$Q_{ijl} = (K_l - \frac{2}{3}G_l)q_{ij}^1 + G_l q_{ij}^2, \quad (9.115)$$

$$S_{ijl} = -V_{jil} = -\alpha_l s_{ij}^1, \quad (9.116)$$

$$R_{ijl} = (K_l + \frac{4}{3}G_l)p_{ij}^2 + G_l p_{ij}^1, \quad (9.117)$$

$$T_{ijl} = -W_{jil} = -\alpha_l t_{ij}^1, \quad (9.118)$$

$$U_{ijl} = S_l c_{ij}^1 + \frac{\kappa_l}{\mu_l} d_{ij}^1 \Delta t. \quad (9.119)$$

The nodal forces F_x^i and F_y^i in equations (9.83) and (9.84), acting in node i , can be calculated by integrating the distributed body forces in the elements over these elements, see equations (9.58) and (9.71). For element p the total force is

$$F_x = \iint_{R_i} f_x dx dy, \quad (9.120)$$

$$F_y = \iint_{R_l} f_y dx dy, \quad (9.121)$$

where f_x and f_y are the body forces in element l , in x - and y -directions. The forces must be distributed over the nodes of element l , each node obtaining $\frac{1}{4}$ of the total force, if the elements are quadrangles.

In terms of the isoparametric coordinates the expressions (9.120) and (9.121) become, assuming that the body forces are constant in the element,

$$F_x = f_x \iint_{R_l} \det(\mathbf{J}_{ij}) d\xi d\eta, \quad (9.122)$$

$$F_y = f_y \iint_{R_l} \det(\mathbf{J}_{ij}) d\xi d\eta. \quad (9.123)$$

The integrals represent the area of element p , which can most conveniently be calculated by summing the values of $\det(\mathbf{J}_{ij})$ in the four Gauss points.

9.2.5 Stresses

The effective stresses can be expressed in the displacements by Hooke's law. For an isotropic material this is

$$\begin{aligned} \sigma'_{xx} &= -(\lambda + 2\mu) \frac{\partial u}{\partial x} - \lambda \frac{\partial v}{\partial y}, \\ \sigma'_{yy} &= -(\lambda + 2\mu) \frac{\partial v}{\partial y} - \lambda \frac{\partial u}{\partial x}, \\ \sigma'_{xy} &= -\mu \frac{\partial u}{\partial y} - \mu \frac{\partial v}{\partial x}, \end{aligned} \quad (9.124)$$

where λ and μ are Lamé's constants.

In element p the displacements can be expressed by the first two of equations (9.92),

$$u = \sum_{k=1}^4 N_k u_k, \quad v = \sum_{k=1}^4 N_k v_k. \quad (9.125)$$

It follows that the stresses in an element can be expressed as

$$\begin{aligned} \sigma'_{xx} &= -(\lambda + 2\mu) \sum_{k=1}^4 \frac{\partial N_k}{\partial x} u_k - \lambda \sum_{k=1}^4 \frac{\partial N_k}{\partial y} v_k, \\ \sigma'_{yy} &= -(\lambda + 2\mu) \sum_{k=1}^4 \frac{\partial N_k}{\partial y} v_k - \lambda \sum_{k=1}^4 \frac{\partial N_k}{\partial x} u_k, \\ \sigma'_{xy} &= -\mu \sum_{k=1}^4 \frac{\partial N_k}{\partial y} u_k - \mu \sum_{k=1}^4 \frac{\partial N_k}{\partial x} v_k. \end{aligned} \quad (9.126)$$

The stresses are a function of x and y , or of ξ and η . Unlike the displacements, the stresses are in general not continuous in the nodal points, not even if the material properties are constant. It seems practical to consider the average stress in an element as representative. These average stresses can be calculated by taking the average of the values in the four Gauss points.

9.2.6 Undrained response

It is sometimes desirable or convenient to calculate the immediate response of a poroelastic medium to a sudden load, ignoring all drainage. The time-dependent consolidation of the medium may follow this initial behaviour. The determination of the immediate (*undrained*) response might be attempted by considering the system of equations with a time step of zero magnitude, $\Delta t = 0$. In that case, however, the system of equations degenerates, and becomes ill-conditioned. A special approach may be followed to investigate this undrained behaviour.

It is recalled, from (9.1), (9.4) and (9.5) that the basic differential equations for plane strain poroelasticity are

$$\alpha \frac{\partial e}{\partial t} + S \frac{\partial p}{\partial t} - \frac{\partial}{\partial x} \left(\frac{\kappa}{\mu} \frac{\partial p}{\partial x} \right) - \frac{\partial}{\partial y} \left(\frac{\kappa}{\mu} \frac{\partial p}{\partial y} \right) = 0, \quad (9.127)$$

$$\frac{\partial \sigma_{xx}}{\partial x} + \frac{\partial \sigma_{yx}}{\partial y} - f_x = 0, \quad (9.128)$$

$$\frac{\partial \sigma_{xy}}{\partial x} + \frac{\partial \sigma_{yy}}{\partial y} - f_y = 0, \quad (9.129)$$

The total stresses can be related to the displacements and the pore pressure through the equations (9.15),

$$\begin{aligned} \sigma_{xx} &= -(K + \frac{4}{3}G) \frac{\partial u}{\partial x} - (K - \frac{2}{3}G) \frac{\partial v}{\partial y} + \alpha p, \\ \sigma_{yy} &= -(K + \frac{4}{3}G) \frac{\partial v}{\partial y} - (K - \frac{2}{3}G) \frac{\partial u}{\partial x} + \alpha p, \\ \sigma_{xy} &= -G \frac{\partial u}{\partial y} - G \frac{\partial v}{\partial x}. \end{aligned} \quad (9.130)$$

By integrating the storage equation (9.127) over a very small time step Δt , and assuming that the divergence of the specific discharge vector, expressed by the last two terms in equation (9.127), is finite, it follows, assuming that the initial values of the volume strain e and the pore pressure p are zero, that

$$\alpha e + Sp = 0. \quad (9.131)$$

If the storativity $S = 0$ this means that the material is incompressible, $e = 0$. Assuming that the storativity is unequal to zero, $S > 0$, it follows that

$$p = -\alpha e / S. \quad (9.132)$$

Using this relation the total stresses can be expressed as

$$\begin{aligned} \sigma_{xx} &= -(K_u + \frac{4}{3}G) \frac{\partial u}{\partial x} - (K - \frac{2}{3}G) \frac{\partial v}{\partial y}, \\ \sigma_{yy} &= -(K_u + \frac{4}{3}G) \frac{\partial v}{\partial y} - (K - \frac{2}{3}G) \frac{\partial u}{\partial x}, \\ \sigma_{xy} &= -G \frac{\partial u}{\partial y} - G \frac{\partial v}{\partial x}, \end{aligned} \quad (9.133)$$

where

$$K_u = K + \alpha^2 / S, \quad (9.134)$$

the *undrained compression modulus*.

Because the equations of equilibrium can be expressed completely in terms of the total stresses, and the boundary conditions for the porous medium are expressed in terms of the total stresses or the displacements, see equations (9.20) and (9.21), it follows that the initial response at time $t = 0$, the moment of loading, can be determined as the solution of a problem of elasticity, for a material with shear modulus G and compression modulus K_u . In the special case that the solid particles and the pore fluid are both incompressible the storativity $S = 0$, see equation (9.3), and then the undrained porous material is incompressible, $K_u \rightarrow \infty$. In that case the response may be very difficult or impossible to determine, because the system of equations degenerates. A good approximation of the undrained response may be determined, however, by introducing a small compressibility for the pore fluid, so that the order of magnitude of the factor α^2/S is large compared to the drained compression modulus K , but not infinitely large, say $\alpha^2/S = 100 * K$.

For the analysis of the undrained response the system of equations (9.83), (9.84) and (9.85) can be used in its original form, but the matrices S_{ij} and T_{ij} should be ignored (meaning that their values should be set to zero), and the matrix U_{ij} should be restricted to the contribution C_{ij} . In the matrices P_{ij} , Q_{ij} and R_{ij} the compression modulus should be taken as K_u , see equation (9.134).

Another, and perhaps simpler, approach is to let the original computer program find the undrained solution, by setting all the boundary conditions for the pore pressure as impermeable, and assuming a small time step in which the undrained response may be calculated. The value of time after that initial time step can be reset to zero, before the progress of the consolidation process is calculated, using the actual boundary conditions for the pore pressure.

9.3 Computer program

A computer program, POROFEM, to solve the system of equations (9.83), (9.84) and (9.85) has been developed, using Borland's C++ Builder. These equations are

$$\sum_{j=1}^n P_{ij}u_j + \sum_{j=1}^n Q_{ij}v_j + \sum_{j=1}^n S_{ij}p_j = F_{xi}, \quad (9.135)$$

$$\sum_{j=1}^n Q_{ji}u_j + \sum_{j=1}^n R_{ij}v_j + \sum_{j=1}^n T_{ij}p_j = F_{yi}, \quad (9.136)$$

$$\sum_{j=1}^n V_{ij}u_j + \sum_{j=1}^n W_{ij}v_j + \sum_{j=1}^n U_{ij}p_j = QQ_i. \quad (9.137)$$

The system of equations is solved by an iterative method, Bi-CGSTAB (Van der Vorst, 1992). To accelerate the convergence of the solution a modified Jacobi preconditioner is used, in which all equations are normalized by division by its largest coefficient. In the first two equations the largest coefficient usually is the term on the main diagonal, but in the third equation the term on the main diagonal may be very small, indicating that the system may be ill-conditioned. Iterations should continue until the residue (the sum of the squares of the components of the error vector) is smaller than a given number, for instance 10^{-24} , 10^{-36} or 10^{-48} . Experience has shown that the solution is most stable and most accurate if the parameter ϵ is taken as $\epsilon = 1$, indicating backward interpolation, and using lumped storage, but the program will also give good results for smaller values of ϵ , provided that $\epsilon > 0.5$ to ensure stability (Booker & Small, 1974).

Time steps

The success and accuracy of the finite element method for the solution of poroelastic problems is strongly dependent upon the magnitude of the time steps. If the time steps are taken too large the solution may be unstable. On the other hand, the time steps must not be taken too small either, to avoid inaccuracies (Vermeer & Verruijt, 1981). The criterion is

$$\Delta t \geq \frac{(\Delta h)^2}{6\epsilon c}, \quad (9.138)$$

where c is the consolidation coefficient, see equation (6.27), and Δh is the element size (or $(\Delta h)^2$ is the element area). This sensitivity is a consequence of the approximation of the basic variables by linear shape functions, which requires that in a single time step the consolidation process in an element must have been completed. Reasonable convergence can be obtained if the duration of the entire consolidation process can be estimated, and then taking 20, 50 or even more time steps of equal magnitude to describe the process. To obtain sufficient accuracy it is the first time step should be such that in all of the elements the consolidation process has progressed up to say $ct/\ell^2 = 2$, where c is the local consolidation coefficient and ℓ is a characteristic element size, for instance such that $A = \ell^2$, where A is the area of the element. This means that the magnitude of this first time step is determined by the element in which consolidation is the slowest. In the program POROFEM the magnitude of the first time step must be given by the user as an input value in the grid of parameters. Subsequent time steps may be taken gradually somewhat larger, for instance by prescribing the values of time (in the screen "Times") in ratios 1:2:3:5:7:10:20:30:50:70:100, etc. However, most accurate results usually are obtained by keeping the time step constant, at the cost of computation time, of course. The program will store output data for a number of values of time (NT) prescribed by the user (in the screen "Times"). These output data are stored in the files "Data.1", "Data.2", etc., if "Data.pl4" is the datafile containing the input data of the problem considered. The procedure is such that in the program each interval between subsequent output values of time may be subdivided into a number of subintervals (NS), say NS=2 or NS=4, in order to obtain sufficient accuracy, without storing too many output data.

The initial state is determined in a separate undrained analysis, in which all boundaries are impermeable, and a time step is used equal to one-half of the first output step. The results of this undrained analysis are stored in the file "Data.0".

The type of problems solved by the program are for a soil mass which is in equilibrium at time $t = 0$, and is loaded at that moment by some external loads, which remain constant in time. As mentioned above, the initial response is calculated using an initial small time step, in which the undrained response can be calculated, using

the boundary conditions for the displacements and the total stresses, but ignoring the given pore pressures on a boundary. Because the pore pressure in each node must be determined from the local volume strain, and this is not defined in the nodes, but must be determined on the average, it is most convenient to use a lumping procedure in the matrix C_{ij} , in which all non-zero terms involving the pore pressure are lumped together on the main diagonal. Ignoring the boundary conditions for the pore pressure implies that the pore pressure along such boundaries will not be zero, as the boundary is considered as an impermeable boundary. In the next time step (the first non-zero time step) the pore pressure along such a boundary shows a sudden jump, as it jumps to the zero value prescribed by the boundary condition. This is in agreement with the usual approach in analytical solution methods. For instance, in Terzaghi's problem of one-dimensional consolidation of a soil sample, the initial pore pressure is considered to be constant, up to the drained boundary, and then for $t > 0$ the pore pressure at the drained boundary is set equal to zero.

For the time steps after the initial undrained step the storage equation may give rise to instabilities, especially if the compressibility of the fluid and the particles are very small. These instabilities, that often occur in finite element solutions of poroelastic problems, may be suppressed by using a mixed formulation, in which the mechanical equations and the fluid flow equations are solved separately (Ferronato, Castelletto & Gambolati, 2010). In the present chapter these instabilities are suppressed by using a solution in two cycles of iterations, with a physical *preconditioner* in the first cycle.

Rendulic preconditioner

A first possibility is to use the uncoupling method first suggested by Rendulic (1936). In this approach the system of equations is simplified in a first computation cycle by assuming that the isotropic total stress remains constant in the time step considered. In general the volume change can be expressed as

$$\frac{\partial e}{\partial t} = -C_m \frac{\partial(\sigma - \alpha p)}{\partial t}, \quad (9.139)$$

where σ is the isotropic total stress. If this quantity is assumed to be constant in time, as a first approximation, it follows that

$$\frac{\partial e}{\partial t} = \alpha C_m \frac{\partial p}{\partial t}, \quad (9.140)$$

so that the storage equation (9.1) reduces to

$$(\alpha^2 C_m + S) \frac{\partial p}{\partial t} - \frac{\partial}{\partial x} \left(\frac{\kappa}{\mu} \frac{\partial p}{\partial x} \right) - \frac{\partial}{\partial y} \left(\frac{\kappa}{\mu} \frac{\partial p}{\partial y} \right) = 0. \quad (9.141)$$

This is an equation of the diffusion type, in which the coefficient of $\partial p / \partial t$ is never small, because of the factor $\alpha^2 C_m$, which depends upon the compressibility of the soil. The system of equations now is uncoupled, and is not ill-conditioned, so that convergence will be ensured.

Lateral confinement preconditioner

A second possibility for a physical preconditioner is to assume, as a first approximation, that the horizontal deformations are negligible. This seems especially justified in the case of vertical loads only, with some lateral confinement at the boundaries. This means that the volume change consists mainly of the vertical strains,

$$e = \varepsilon_{zz}. \quad (9.142)$$

For a linear elastic material the vertical strain can be related to the vertical effective stress,

$$e = \varepsilon_{zz} = -m_v \sigma'_{zz} = -m_v (\sigma_{zz} - \alpha p), \quad (9.143)$$

where the vertical compressibility m_v can be expressed as

$$m_v = 1 / (K + \frac{4}{3}G), \quad (9.144)$$

see the second of equations (9.9).

It now follows that

$$\frac{\partial e}{\partial t} = -m_v \frac{\partial \sigma_{zz}}{\partial t} + \alpha m_v \frac{\partial p}{\partial t}. \quad (9.145)$$

The storage equation (9.1) now reduces to

$$(\alpha^2 m_v + S) \frac{\partial p}{\partial t} = \alpha m_v \frac{\partial \sigma_{zz}}{\partial t} + \frac{\partial}{\partial x} \left(\frac{\kappa}{\mu} \frac{\partial p}{\partial x} \right) + \frac{\partial}{\partial y} \left(\frac{\kappa}{\mu} \frac{\partial p}{\partial y} \right). \quad (9.146)$$

If the vertical total stress σ_{zz} is assumed to be constant in time this is an equation of the diffusion type, in which the coefficient of $\partial p / \partial t$ is never small, because of the factor $\alpha^2 m_v$, which depends upon the vertical compressibility of the soil. The system of equations now is again uncoupled, and is not ill-conditioned, so that convergence is ensured.

The two cycles of computation

The results of a first cycle of uncoupled computations may be used as a first estimate for the second cycle, in which the full coupled system of equations is solved. Some examples will be presented in the next section. In all examples Rendulic's approximation is used in the first cycle.

9.3.1 Examples

In this section some examples of the application of the program POROFEM are presented.

Example 91, Terzaghi's problem

The first example, the data of which are given in the datafile Example91.pl4, concerns the case of one-dimensional consolidation of a layer of thickness $h = 10$ m, with drainage at the top only. This is Terzaghi's classical problem. The analytical solution of this problem has been given in section 2.2, see Figure 2.3.

In the example the soil data are $K = 500$ kN/m², $G = 375$ kN/m², $C_f = 0.00001$ m²/kN, $C_s = 0$, $k = 0.01004$ m/d, $\gamma_f = 10$ kN/m³, $n = 0.40$. This means that $S = 0.000004$ m²/kN, so that $K + \frac{4}{3}G = 1000$ kN/m², $(K + \frac{4}{3}G)S = 0.004$, and $c = 1$ m²/d. The vertical load at the top is $q = 1.004$ kN/m³, so that the initial pore pressure, in undrained conditions, should be $p_0 = 1$ kN/m². The computer program indeed gives this result, with an accuracy of 6 decimals.

The pore pressures as calculated by the program are shown, for four values of time, $t = 0.1$ d, $t = 1$ d, $t = 10$ d and $t = 100$ d in Figure 9.4. The fully drawn lines indicate the analytical solution, and the dots indicate the numerical solution. The agreement appears to be good, with errors smaller than about 1 %. It

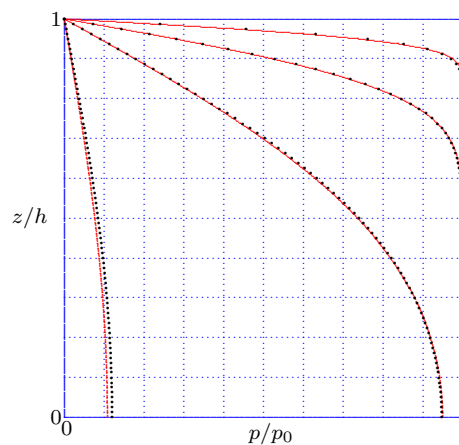

Figure 9.4: Example 91, Terzaghi's problem, $t(d) = 0.1, 1, 10, 100$.

should be mentioned that by using somewhat different values for the parameters of the computation, such as the value of ϵ (which was taken as $\epsilon = 1$), or the magnitude of the time steps, the results may be slightly different.

Example 92, Two-layered soil

As a second example the results are shown for a system of two layers. All the data are the same as in the first example, except that the permeability in the elements in the top half of the soil is a factor 100 larger. The data are assembled in the file Example92.pl4. The pore pressures calculated by the program POROFEM are shown in Figure 9.5, together with the results of an analytical solution. The agreement between analytical and numerical results is good, except for very small values of time, when the errors are about 2 %.

Example 93, Two layered soil

As a third example the results are shown for a system of two layers, with the top layer having a permeability 100 times smaller than the lower layer. The data are assembled in the file Example93.pl4. The pore pressures calculated by the program POROFEM are shown in Figure 9.6, together with the results of an analytical solution. The results of the numerical solution appear to be in good agreement with the analytical solution.

It should be noted that in the examples shown in this section the element sizes are constant, and the permeability contrast is restricted to a factor 100. As already mentioned in section 2.5, a numerical model in which the element sizes are all approximately equal but the permeabilities (or the compressibilities) are very different, with contrasts of a factor as high as 10^4 or 10^6 , may not give accurate results. In order to solve such problems the element sizes should be varied, such that the consolidation times of all elements are of similar orders of magnitude.

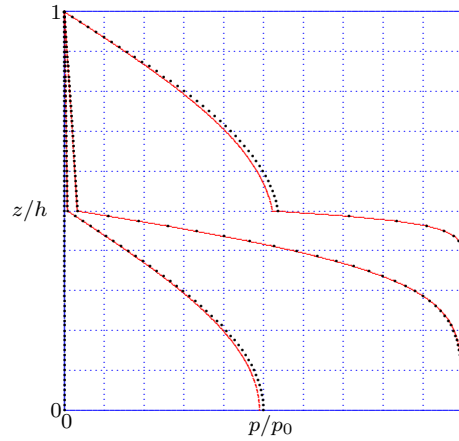

Figure 9.5: Example 92, Permeability contrast 100:1.

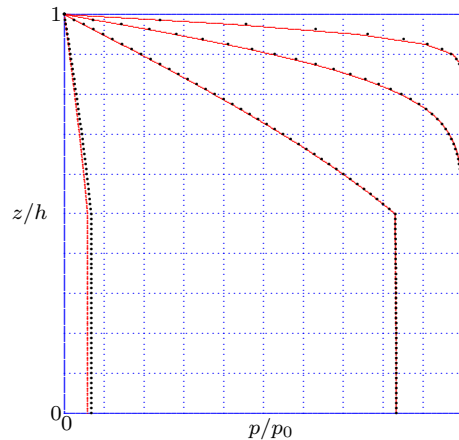
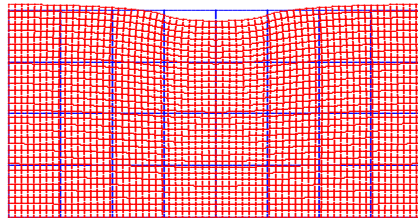

Figure 9.6: Example 93, Permeability contrast 1:100.

Example 94, Strip load on block

The fourth example, described by the file Example94.pl4, refers to a block of soil, loaded by a strip load in the center. The block is supported at its bottom, and the left and right ends are confined, so that there can be no horizontal displacements at these ends. The deformations at the moment of loading ($t = 0$) are shown in Figure 9.7, using a multiplication factor for all displacements of 200. It appears that the incompressibility condition at that time results in a downward displacement in the two central (loaded) sections, and a balancing upward displacement near the two ends, as could be expected. The deformations after consolidation are shown

Figure 9.7: Example 94, Deformations at time $ct/h^2 = 0.0$.

in Figure 9.8. The vertical displacements in the center then are somewhat more than a factor 2 larger, because the pore pressures have been dissipated and the compression modulus now is considerably smaller. The vertical displacements now are in downward direction throughout the soil.

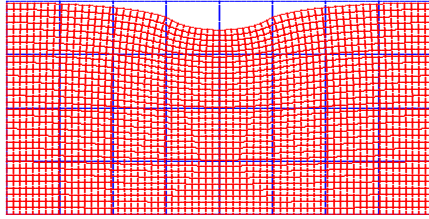
Figure 9.8: Example 94, Deformations at time $ct/h^2 = 2.0$.

Another way to show the displacements is by drawing contours of the vertical displacements. The contours of

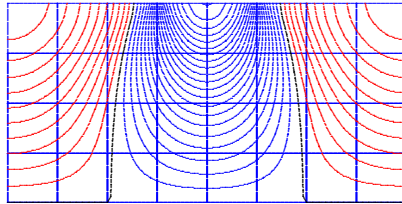
Figure 9.9: Example 94, Vertical displacements at time $ct/h^2 = 0.0$.

the vertical displacement at time $t = 0$ are shown in Figure 9.9. Blue contours indicate a downward displacement, and red contours indicate an upward displacement. The black contours indicate a zero displacement.

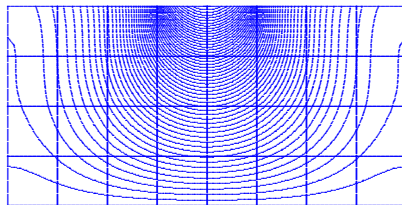
Figure 9.10: Example 94, Vertical displacements at time $ct/h^2 = 2.0$.

For a later time the contours of the vertical displacement are shown in Figure 9.10. All displacements now are in downward direction. These figures are in agreement with the displacement fields shown in Figures 9.7 and 9.8.

Chapter 10

AXIALLY SYMMETRIC FINITE ELEMENTS

10.1 Introduction

Following on the presentation of the finite element method for plane strain problems in the preceding chapter, in this chapter the finite element method is presented for axially symmetric problems of poroelasticity. The problems in this chapter are all described in terms of cylindrical coordinates r and z , with $r = 0$ being the axis of symmetry.

As in the previous chapter the finite element equations are derived using Galerkin's method of establishing approximate equations, and using quadrangular elements with isoparametric shape functions. For a derivation of the basic equations of the theory of poroelasticity see Chapter 1.

10.2 Axially symmetric poroelasticity

In this chapter problems of axially symmetric poroelasticity will be considered, such as the problem illustrated in Figure 10.1, of a uniform load over a circular area of radius a , on an elastic half space. The applied load varies with time, by a step function, indicating that the load is initially zero, is applied at time $t = 0$, and then remains constant.

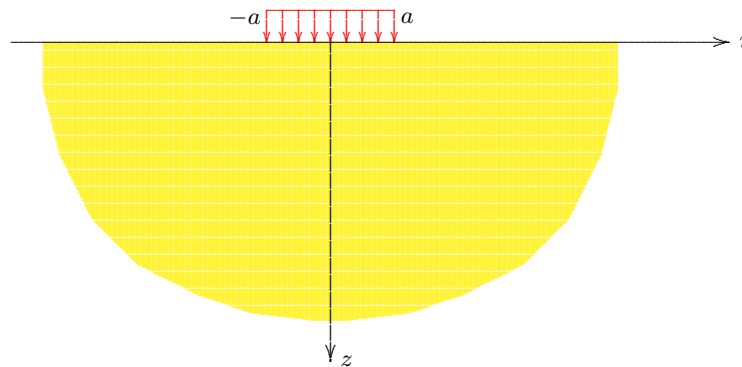

Figure 10.1: Circular load on half space.

10.2.1 Basic equations

The first basic equation for axially symmetric consolidation is the fluid conservation equation in cylindrical coordinates (the storage equation)

$$\alpha \frac{\partial e}{\partial t} + S \frac{\partial p}{\partial t} - \frac{\partial}{\partial r} \left(\frac{\kappa}{\mu} \frac{\partial p}{\partial r} \right) - \frac{1}{r} \frac{\kappa}{\mu} \frac{\partial p}{\partial r} - \frac{\partial}{\partial z} \left(\frac{\kappa}{\mu} \frac{\partial p}{\partial z} \right) = 0, \quad (10.1)$$

where e is the volume strain of the porous medium, p is the pressure in the fluid, κ is the permeability of the porous medium and μ is the viscosity of the fluid. This equation is based upon the principles of conservation of mass of the solids and the fluid, and Darcy's law for the flow of the fluid with respect to the solid material. The factor κ/μ may depend upon the coordinates r and z .

The parameter α , Biot's coefficient, is defined by

$$\alpha = 1 - C_s/C_m, \quad (10.2)$$

where C_s is the compressibility of the solid particles and C_m is the compressibility of the porous medium. For soft soils the compressibility of the particles C_s is much smaller than the compressibility of the porous

medium C_m , so that Biot's coefficient is very close to 1, $\alpha \approx 1$. The parameter S , the storativity, is defined as

$$S = nC_f + (\alpha - n)C_s, \quad (10.3)$$

where n is the porosity of the soil, and C_f is the compressibility of the pore fluid.

The equations of equilibrium in radial and vertical direction are,

$$\frac{\partial \sigma_{rr}}{\partial r} + \frac{\sigma_{rr} - \sigma_{tt}}{r} + \frac{\partial \sigma_{zr}}{\partial z} - f_r = 0, \quad (10.4)$$

$$\frac{\partial \sigma_{rz}}{\partial r} + \frac{\sigma_{rz}}{r} + \frac{\partial \sigma_{zz}}{\partial z} - f_z = 0, \quad (10.5)$$

where f_r and f_z are the components of the body force, a force per unit volume. It may be noted that, to conform with most soil mechanics literature, compressive stresses are considered as positive. This is in disagreement with the usual sign convention in applied mechanics, but is more convenient in soil mechanics. It should be noted that the body forces are considered positive in positive coordinate direction.

Furthermore, it is customary in the analysis of consolidation problems to consider only the incremental displacements and stresses, with respect to some initial state of equilibrium, at time $t = 0$. This initial state is assumed to incorporate the effect of gravity in the porous medium, both in the medium as a whole as in the fluid. This means that for the incremental stresses and displacements due to a given boundary load the body forces can often be assumed to vanish, except when additional body forces are applied after $t = 0$.

The stresses are composed of the effective stresses, which determine the deformations of the soil skeleton, and the pore pressure p , according to Terzaghi's principle, with Biot's correction,

$$\begin{aligned} \sigma_{rr} &= \sigma'_{rr} + \alpha p, \\ \sigma_{tt} &= \sigma'_{tt} + \alpha p, \\ \sigma_{zz} &= \sigma'_{zz} + \alpha p, \\ \sigma_{rz} &= \sigma'_{rz}, \end{aligned} \quad (10.6)$$

where α is Biot's coefficient, defined in equation (10.2).

Substitution of equations (10.6) into equations (10.4) and (10.5) gives the equations of equilibrium expressed in terms of the effective stresses,

$$\frac{\partial \sigma'_{rr}}{\partial r} + \frac{\sigma'_{rr} - \sigma'_{tt}}{r} + \frac{\partial \sigma'_{zr}}{\partial z} + \frac{\partial(\alpha p)}{\partial r} - f_r = 0, \quad (10.7)$$

$$\frac{\partial \sigma'_{rz}}{\partial r} + \frac{\sigma'_{rz}}{r} + \frac{\partial \sigma'_{zz}}{\partial z} + \frac{\partial(\alpha p)}{\partial z} - f_z = 0, \quad (10.8)$$

For an isotropic elastic material the effective stresses are related to the strain components by Hooke's law,

$$\begin{aligned} \sigma'_{rr} &= -(K - \frac{2}{3}G)e - 2G\varepsilon_{rr} = -(K - \frac{2}{3}G)e - 2G\frac{\partial u}{\partial r}, \\ \sigma'_{tt} &= -(K - \frac{2}{3}G)e - 2G\varepsilon_{tt} = -(K - \frac{2}{3}G)e - 2G\frac{u}{r}, \\ \sigma'_{zz} &= -(K - \frac{2}{3}G)e - 2G\varepsilon_{zz} = -(K - \frac{2}{3}G)e - 2G\frac{\partial w}{\partial z}, \\ \sigma'_{rz} &= -2G\varepsilon_{rz} = -G\left(\frac{\partial u}{\partial z} + \frac{\partial w}{\partial r}\right). \end{aligned} \quad (10.9)$$

In these equations u and w are the components of the displacement in radial and vertical direction, respectively. The parameters K and G are the compression modulus and the shear modulus of the material, and e is the volume strain,

$$e = \varepsilon_{rr} + \varepsilon_{tt} + \varepsilon_{zz} = \frac{\partial u}{\partial r} + \frac{u}{r} + \frac{\partial w}{\partial z}. \quad (10.10)$$

The minus signs in equations (10.9) are a consequence of the unusual sign convention for the stresses. The compression modulus K is the inverse of the compressibility C_m ,

$$K = 1/C_m. \quad (10.11)$$

The Lamé constants λ and μ , which are commonly used in elasticity theory, are related to the compression modulus K and the shear modulus G by the relations

$$\lambda = K - \frac{2}{3}G, \quad \mu = G. \quad (10.12)$$

From considerations of elementary continuum mechanics it follows that both K and G must be non-negative,

$$K \geq 0, \quad G \geq 0. \quad (10.13)$$

Although soils in engineering practice show considerable deviations from the linear isotropic elastic behaviour assumed above, this approximation will be used throughout this chapter. If problems can be solved using this assumption, there may be some hope that problems for more complex material behaviour are solvable.

Using equations (10.6) and (10.9) the total stresses can be expressed into the displacements as

$$\begin{aligned} \sigma_{rr} &= -(K - \frac{2}{3}G)e - 2G\frac{\partial u}{\partial r} + \alpha p, \\ \sigma_{tt} &= -(K - \frac{2}{3}G)e - 2G\frac{u}{r} + \alpha p, \\ \sigma_{zz} &= -(K - \frac{2}{3}G)e - 2G\frac{\partial w}{\partial z} + \alpha p, \\ \sigma_{rz} &= -G\left(\frac{\partial u}{\partial z} + \frac{\partial w}{\partial r}\right). \end{aligned} \quad (10.14)$$

With equations (10.7), (10.8) and (10.9) the equations of equilibrium can be expressed into the displacements as

$$\frac{\partial}{\partial r} [(K - \frac{2}{3}G)e] + \frac{\partial}{\partial r} [2G\frac{\partial u}{\partial r}] + \frac{\partial}{\partial z} [G\frac{\partial u}{\partial z} + G\frac{\partial w}{\partial r}] + \frac{2G}{r} [\frac{\partial u}{\partial r} - \frac{u}{r}] - \frac{\partial(\alpha p)}{\partial r} + f_r = 0, \quad (10.15)$$

$$\frac{\partial}{\partial z} [(K - \frac{2}{3}G)e] + \frac{\partial}{\partial z} [2G\frac{\partial w}{\partial z}] + \frac{\partial}{\partial r} [G\frac{\partial u}{\partial z} + G\frac{\partial w}{\partial r}] + \frac{G}{r} [\frac{\partial u}{\partial z} + \frac{\partial w}{\partial r}] - \frac{\partial(\alpha p)}{\partial z} + f_z = 0. \quad (10.16)$$

The three equations (10.1), (10.15) and (10.16) are the basic equations of the theory of axially symmetric poroelasticity, expressed in the three basic variables: the two displacement components u and w , and the pore water pressure p .

It may be noted that for a homogeneous material, with K , G and α independent of r and z , these equations reduce to

$$(K + \frac{1}{3}G)\frac{\partial e}{\partial r} + G\left(\frac{\partial^2 u}{\partial r^2} + \frac{1}{r}\frac{\partial u}{\partial r} - \frac{u}{r^2} + \frac{\partial^2 u}{\partial z^2}\right) - \alpha\frac{\partial p}{\partial r} + f_r = 0, \quad (10.17)$$

$$(K + \frac{1}{3}G)\frac{\partial e}{\partial z} + G\left(\frac{\partial^2 w}{\partial r^2} + \frac{1}{r}\frac{\partial w}{\partial r} + \frac{\partial^2 w}{\partial z^2}\right) - \alpha\frac{\partial p}{\partial z} + f_z = 0. \quad (10.18)$$

In this form the equilibrium equations are particularly useful for the derivation of analytical solutions of consolidation problems. In this chapter, which is oriented towards the establishment of numerical solutions, the equations for a non-homogeneous material are used as the starting equations for further analysis.

The boundary conditions in the r, z -plane are supposed to be that on one part of the boundary (S_1) the surface tractions are prescribed, and that on the remaining part (S_2) the displacements are prescribed. Formally this can be expressed as follows.

$$P \in S_1 : \begin{cases} \sigma_{nr} = \sigma_{rr}n_r + \sigma_{zr}n_z = -t_r, \\ \sigma_{nz} = \sigma_{rz}n_r + \sigma_{zz}n_z = -t_z. \end{cases} \quad (10.19)$$

and

$$P \in S_2 : \begin{cases} u = a, \\ w = b. \end{cases} \quad (10.20)$$

where S_1 and S_2 are disjoint parts of the boundary S , together forming the entire boundary. On S_1 the surface tractions t_r and t_z are prescribed (positive in positive coordinate direction), and on S_2 the displacement components are prescribed, as a and b , respectively.

Boundary conditions should also be specified for the pore fluid. These are assumed to be that on one part of the boundary (S_3) the pore pressure is prescribed, and that on the remaining part of the boundary (S_4) the flux is prescribed,

$$P \in S_3 : p = h, \quad (10.21)$$

$$P \in S_4 : \frac{\kappa}{\mu} \frac{\partial p}{\partial n} = q, \quad (10.22)$$

where S_3 and S_4 are disjoint parts of the boundary S , together forming the entire boundary. On S_3 the pore pressure p is prescribed, as h , and on S_4 the flux supplied to the porous medium is prescribed, as the quantity q .

It is assumed without further investigation that the shape of the boundary and the nature of the boundary conditions ensure the existence of a unique solution of the problem defined by the equations given above. This may be the case only if the boundary conditions satisfy certain regularity conditions, such as global equilibrium and global continuity.

10.2.2 Time step

A convenient procedure of solving a consolidation problem numerically is to calculate the increment of the pore pressure p and the displacements u and w after a small time step Δt , assuming that these quantities are known at the beginning of this time step. The values at the end of the time step can then be considered as the initial values for the next step, and the process of consolidation can be analyzed step by step. The basic equations for this procedure can be obtained by integrating the basic equations presented in the previous section over a time step from $t = t_0$ to $t = t_0 + \Delta t$. For the storage equation (10.1) this gives

$$\alpha[e(t_0 + \Delta t) - e(t_0)] + S[p(t_0 + \Delta t) - p(t_0)] - \Delta t \left[\frac{\partial}{\partial r} \left(\frac{\kappa}{\mu} \frac{\partial \bar{p}}{\partial r} \right) + \frac{1}{r} \frac{\kappa}{\mu} \frac{\partial \bar{p}}{\partial r} + \frac{\partial}{\partial z} \left(\frac{\kappa}{\mu} \frac{\partial \bar{p}}{\partial z} \right) \right] = 0, \quad (10.23)$$

where \bar{p} is the average of the pore pressure during the time step,

$$\bar{p} = \frac{1}{\Delta t} \int_{t_0}^{t_0 + \Delta t} p dt. \quad (10.24)$$

It is now assumed that the average values of all quantities during a time step can be expressed in the values at the end and the beginning of the time step by formulas of the type

$$\bar{p} = (1 - \epsilon)p(t_0) + \epsilon p(t_0 + \Delta t), \quad (10.25)$$

where ϵ is an interpolation parameter. A value $\epsilon = 0$ would be indicative of a forward finite difference approximation, and a value $\epsilon = 1$ would be indicative for a backward finite difference approximation. It may be expected that the most accurate results are obtained if $\epsilon \approx 0.5$. The analogy with finite difference methods for diffusion type problems suggests that forward extrapolation may lead to unstable procedures, and can best be avoided. Thus it is suggested to take

$$0.5 \leq \epsilon \leq 1.0. \quad (10.26)$$

It has been shown (Booker & Small, 1974) that this ensures that the numerical process is stable.

It follows from equation (10.25) that

$$p(t_0 + \Delta t) - p(t_0) = \frac{\bar{p} - p_0}{\epsilon}, \quad (10.27)$$

where $p^0 = p(t_0)$. Similarly, with $e_0 = e(t_0)$,

$$e(t_0 + \Delta t) = e_0 + (\bar{e} - e_0)/\epsilon. \quad (10.28)$$

Substitution of these expressions into equation (10.23) finally gives the storage equation in time averaged form as

$$\alpha(\bar{e} - e_0) + S(\bar{p} - p_0) - \epsilon \Delta t \left[\frac{\partial}{\partial r} \left(\frac{\kappa}{\mu} \frac{\partial \bar{p}}{\partial r} \right) + \frac{1}{r} \frac{\kappa}{\mu} \frac{\partial \bar{p}}{\partial r} + \frac{\partial}{\partial z} \left(\frac{\kappa}{\mu} \frac{\partial \bar{p}}{\partial z} \right) \right] = 0. \quad (10.29)$$

The time averaged form of the equations of equilibrium (10.4) and (10.5) is

$$\frac{\partial \bar{\sigma}_{rr}}{\partial r} + \frac{\bar{\sigma}_{rr} - \bar{\sigma}_{tt}}{r} + \frac{\partial \bar{\sigma}_{zr}}{\partial z} - \bar{f}_r = 0, \quad (10.30)$$

$$\frac{\partial \bar{\sigma}_{rz}}{\partial r} + \frac{\bar{\sigma}_{rz}}{r} + \frac{\partial \bar{\sigma}_{zz}}{\partial z} - \bar{f}_z = 0, \quad (10.31)$$

where \bar{f}_r and \bar{f}_z are the averaged values of the body force in the time step considered. They are defined by expressions similar to equation (10.25),

$$\bar{f}_r = (1 - \epsilon)f_r(t_0) + \epsilon f_r(t_0 + \Delta t), \quad (10.32)$$

$$\bar{f}_z = (1 - \epsilon)f_z(t_0) + \epsilon f_z(t_0 + \Delta t). \quad (10.33)$$

The time averaged stresses are related to the time averaged displacements and the time averaged pore pressure by relations equivalent to equations (10.6) and (10.9).

The averaged quantities should satisfy the averaged forms of the boundary conditions

$$P \in S_1 : \begin{cases} \bar{\sigma}_{nr} = \bar{\sigma}_{rr}n_r + \bar{\sigma}_{zr}n_z = -\bar{t}_r, \\ \bar{\sigma}_{nz} = \bar{\sigma}_{rz}n_r + \bar{\sigma}_{zz}n_z = -\bar{t}_z. \end{cases} \quad (10.34)$$

$$P \in S_2 : \begin{cases} \bar{u} = \bar{a}, \\ \bar{w} = \bar{b}, \end{cases} \quad (10.35)$$

$$P \in S_3 : \bar{p} = \bar{h}, \quad (10.36)$$

$$P \in S_4 : \frac{\kappa}{\mu} \frac{\partial \bar{p}}{\partial n} = \bar{q}. \quad (10.37)$$

Backward interpolation

The basic equations are somewhat simpler if the interpolation parameter ϵ is assumed to be $\epsilon = 1$, indicating backward interpolation. Experience has shown that this usually leads to sufficiently accurate results. This simplified version of the equations is assumed to apply in the sequel of this chapter.

Equation (10.29) now becomes

$$\alpha(e_1 - e_0) + S(p_1 - p_0) - \Delta t \left[\frac{\partial}{\partial r} \left(\frac{\kappa}{\mu} \frac{\partial p_1}{\partial r} \right) + \frac{1}{r} \frac{\kappa}{\mu} \frac{\partial p_1}{\partial r} + \frac{\partial}{\partial z} \left(\frac{\kappa}{\mu} \frac{\partial p_1}{\partial z} \right) \right] = 0. \quad (10.38)$$

where p_1 is the pressure at the end of the first time step,

$$p_1 = p(t_0 + \Delta t), \quad (10.39)$$

and e_1 is the volume strain at the end of this step.

For all other variables the average values reduce to the values at time $t = t_0 + \Delta t$.

10.2.3 The Galerkin method

There are various methods to develop numerical methods for the approximate solution of the equations presented in the previous section. A powerful method is the finite element method, in which the region occupied by the body is subdivided into a large number of small elements, and the numerical equations are obtained by assuming a certain simplified variation of the basic variables (the displacements and the pore pressure) in each element. Simple elements that are often used are triangles, see figure 10.2, or quadrangles.

It is assumed that the basic parameters, the displacement components u and w , and the pore pressure p can be approximated by

$$u = \sum_{j=1}^n N_j(r, z)u_j, \quad w = \sum_{j=1}^n N_j(r, z)w_j, \quad p = \sum_{j=1}^n N_j(r, z)p_j, \quad (10.40)$$

where n is the number of nodes in the mesh of finite elements, and u_j , w_j and p_j are the approximate values of u , w and p at node j . The functions $N_j(x, y)$ are shape functions. They will be specified later.

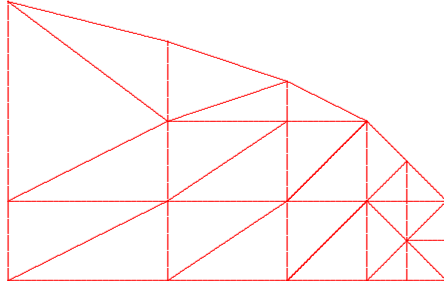

Figure 10.2: Mesh of triangular elements.

It follows from the first two of equations (10.40) that the volume strain e can be approximated by

$$e = \frac{\partial u}{\partial r} + \frac{u}{r} + \frac{\partial w}{\partial z} = \sum_{j=1}^n \left(\frac{\partial N_j}{\partial r} u_j + \frac{N_j}{r} u_j + \frac{\partial N_j}{\partial z} w_j \right). \quad (10.41)$$

The effective stresses are, with equations (10.9), (10.40) and (10.41),

$$\begin{aligned} \sigma'_{rr} &= -(K + \frac{4}{3}G) \sum_{j=1}^n \frac{\partial N_j}{\partial r} u_j - (K - \frac{2}{3}G) \sum_{j=1}^n \left(\frac{N_j}{r} u_j + \frac{\partial N_j}{\partial z} w_j \right), \\ \sigma'_{tt} &= -(K + \frac{4}{3}G) \sum_{j=1}^n \frac{N_j}{r} u_j - (K - \frac{2}{3}G) \sum_{j=1}^n \left(\frac{\partial N_j}{\partial r} u_j + \frac{\partial N_j}{\partial z} w_j \right), \\ \sigma'_{zz} &= -(K + \frac{4}{3}G) \sum_{j=1}^n \frac{\partial N_j}{\partial z} w_j - (K - \frac{2}{3}G) \sum_{j=1}^n \left(\frac{\partial N_j}{\partial r} u_j + \frac{N_j}{r} u_j \right), \\ \sigma'_{rz} &= -G \sum_{j=1}^n \frac{\partial N_j}{\partial z} u_j - G \sum_{j=1}^n \frac{\partial N_j}{\partial r} w_j. \end{aligned} \quad (10.42)$$

The total stresses are, with equations (10.6),

$$\begin{aligned} \sigma_{rr} &= -(K + \frac{4}{3}G) \sum_{j=1}^n \frac{\partial N_j}{\partial r} u_j - (K - \frac{2}{3}G) \sum_{j=1}^n \left(\frac{N_j}{r} u_j + \frac{\partial N_j}{\partial z} w_j \right) + \alpha \sum_{j=1}^n N_j p_j, \\ \sigma_{tt} &= -(K + \frac{4}{3}G) \sum_{j=1}^n \frac{N_j}{r} u_j - (K - \frac{2}{3}G) \sum_{j=1}^n \left(\frac{\partial N_j}{\partial r} u_j + \frac{\partial N_j}{\partial z} w_j \right) + \alpha \sum_{j=1}^n N_j p_j, \\ \sigma_{zz} &= -(K + \frac{4}{3}G) \sum_{j=1}^n \frac{\partial N_j}{\partial z} w_j - (K - \frac{2}{3}G) \sum_{j=1}^n \left(\frac{\partial N_j}{\partial r} u_j + \frac{N_j}{r} u_j \right) + \alpha \sum_{j=1}^n N_j p_j, \\ \sigma_{rz} &= -G \sum_{j=1}^n \frac{\partial N_j}{\partial z} u_j - G \sum_{j=1}^n \frac{\partial N_j}{\partial r} w_j. \end{aligned} \quad (10.43)$$

The approximation of the displacements by equations (10.40) means that the basic differential equations cannot be satisfied identically, of course. However, a good approximation can probably be obtained by requiring that the differential equations are satisfied on the (spatial) average, using appropriate weight functions. In the Galerkin method the weight functions are chosen in the form of the shape functions $N_j(x, y)$. The three equations will be elaborated successively.

Equilibrium in r -direction

The incremental form of the equation of equilibrium in r -direction, equation (10.30), can be satisfied on the average by requiring that

$$\iint_R \left[\frac{\partial \sigma_{rr}}{\partial r} + \frac{\sigma_{rr} - \sigma_{tt}}{r} + \frac{\partial \sigma_{zr}}{\partial z} - f_r \right] N_i r dr dz = 0. \quad (10.44)$$

This equation should be satisfied for all values of $i = 1, \dots, n$, with the exception of the values of i for which the boundary displacement u_i is prescribed.

Because

$$\left[\frac{\partial \sigma_{rr}}{\partial r} + \frac{\sigma_{rr} - \sigma_{tt}}{r} + \frac{\partial \sigma_{zr}}{\partial z} \right] r N_i = \frac{\partial}{\partial r} [r \sigma_{rr} N_i] + \frac{\partial}{\partial z} [r \sigma_{zr} N_i] - r \sigma_{rr} \frac{\partial N_i}{\partial r} - r \sigma_{zr} \frac{\partial N_i}{\partial z} - \sigma_{tt} N_i, \quad (10.45)$$

equation (10.44) can be written as

$$R_1 + R_2 + R_3 = 0, \quad (10.46)$$

where

$$R_1 = \iint_R \left\{ \frac{\partial}{\partial r} [r \sigma_{rr} N_i] + \frac{\partial}{\partial z} [r \sigma_{zr} N_i] \right\} dr dz, \quad (10.47)$$

$$R_2 = - \iint_R \left\{ \sigma_{rr} \frac{\partial N_i}{\partial r} + \sigma_{zr} \frac{\partial N_i}{\partial z} + \sigma_{tt} \frac{N_i}{r} \right\} r dr dz, \quad (10.48)$$

$$R_3 = - \iint_R f_r N_i r dr dz. \quad (10.49)$$

Each of these integrals will be elaborated separately.

The first integral can be transformed into a surface integral by Gauss' divergence theorem. The result is

$$R_1 = \int_S \sigma_{nr} r N_i dS = - \sum \frac{1}{2} t_r \bar{r} L, \quad (10.50)$$

where $-t_r$ is the surface stress σ_{nr} on an element side on the boundary S (a boundary segment), \bar{r} is the average value of the radial coordinate on that segment, and L is the length of the segment. It should be noted that it has been assumed that the element is so small that the average value r is a good approximation of the radial coordinate along the boundary element.

The summation in equation (10.50) is over all element sides along the boundary which contain node i . Because values of i on the boundary S_2 do not apply, only boundary segments on S_1 occur in equation (10.50), on which t_r is given. The factor $\frac{1}{2}$ occurs because the average value of the shape function N_i over a boundary segment containing node i is assumed to be $\frac{1}{2}$. It seems appropriate that the total force on a boundary segment is distributed homogeneously over its two nodes.

The second integral can be elaborated by substituting three of the expressions (10.43) for the total stresses into equation (10.48). This gives

$$\begin{aligned} R_2 = - \iint_R \sum_{j=1}^n \left\{ (K + \frac{4}{3}G) \left(\frac{\partial N_i}{\partial r} \frac{\partial N_j}{\partial r} + \frac{N_i}{r} \frac{N_j}{r} \right) u_j + (K - \frac{2}{3}G) \left(\frac{\partial N_i}{\partial r} \frac{N_j}{r} + \frac{N_i}{r} \frac{\partial N_j}{\partial r} \right) u_j \right. \\ \left. + (K - \frac{2}{3}G) \left(\frac{\partial N_i}{\partial r} \frac{\partial N_j}{\partial z} + \frac{N_i}{r} \frac{\partial N_j}{\partial z} \right) w_j + G \frac{\partial N_i}{\partial z} \left(\frac{\partial N_j}{\partial z} u_j + \frac{\partial N_j}{\partial r} w_j \right) \right. \\ \left. - \alpha \left(\frac{\partial N_i}{\partial r} + \frac{N_i}{r} \right) N_j \bar{p}_j \right\} r dr dz. \end{aligned} \quad (10.51)$$

The integral is over the entire area R , which can be considered as the sum of all elements,

$$R = \sum_{l=1}^m R_l, \quad (10.52)$$

where R_l is a typical element, and m is the number of elements. The integral (10.51) can now be written as

$$R_2 = \sum_{l=1}^m \sum_{j=1}^n (P_{ijl} u_j + Q_{ijl} w_j + S_{ijl} p_j), \quad (10.53)$$

where now

$$P_{ijl} = (K_l + \frac{4}{3}G_l) \iint_{R_l} \left(\frac{\partial N_i}{\partial r} \frac{\partial N_j}{\partial r} + \frac{N_i}{r} \frac{N_j}{r} \right) r dr dz + (K_l - \frac{2}{3}G_l) \iint_{R_l} \left(\frac{\partial N_i}{\partial r} \frac{N_j}{r} + \frac{N_i}{r} \frac{\partial N_j}{\partial r} \right) r dr dz + G_l \iint_{R_l} \frac{\partial N_i}{\partial z} \frac{\partial N_j}{\partial z} r dr dz. \quad (10.54)$$

$$Q_{ijl} = (K_l - \frac{2}{3}G_l) \iint_{R_l} \left(\frac{\partial N_i}{\partial r} \frac{\partial N_j}{\partial z} + \frac{N_i}{r} \frac{\partial N_j}{\partial z} \right) r dr dz + G_l \iint_{R_l} \frac{\partial N_i}{\partial z} \frac{\partial N_j}{\partial r} r dr dz. \quad (10.55)$$

$$S_{ijl} = -\alpha_l \iint_{R_l} \left(\frac{\partial N_i}{\partial r} + \frac{N_i}{r} \right) N_j r dr dz. \quad (10.56)$$

It has been assumed that the material properties are constant in element l , and denoted by K_l , G_l and α_l . It is one of the important characteristics of the finite element method that the material properties may be different in each element, and that no further considerations are needed to satisfy equilibrium and fluid continuity at an interface.

The third integral consists of an integral of the body force f_r over the region R , multiplied by the shape function N_i , see equation (10.49). Only the elements which contain node i contribute to this integral, and for such elements the average value of the shape function is assumed to be $1/k$, where k is the number of nodes per element (for instance 3 or 4). Thus the integral consists of elementary contributions of the form

$$R_3 = -F_r^i = -\sum_{l=1}^m \frac{A_l f_r}{k}, \quad (10.57)$$

where A_l is the area of element l . The body force multiplied by the area of the element represents the total force exerted upon the element by the body forces in that element. Assuming that there is no bias in the shape functions, each node carries an equal share of the total body force in an element.

Equilibrium in z -direction

The equation of equilibrium in z -direction, equation (10.31), can be satisfied on the average by requiring that

$$\iint_R \left[\frac{\partial \sigma_{rz}}{\partial r} + \frac{\sigma_{rz}}{r} + \frac{\partial \sigma_{zz}}{\partial z} - f_z \right] r dr dz = 0. \quad (10.58)$$

This equation should be satisfied for all values of $i = 1, \dots, n$, with the exception of the values of i for which the boundary displacement w_i is prescribed.

Because

$$\left[\frac{\partial \sigma_{rz}}{\partial r} + \frac{\sigma_{rz}}{r} + \frac{\partial \sigma_{zz}}{\partial z} \right] r N_i = \frac{\partial}{\partial r} [r \sigma_{rz} N_i] + \frac{\partial}{\partial z} [r \sigma_{zz} N_i] - r \sigma_{rz} \frac{\partial N_i}{\partial r} - r \sigma_{zz} \frac{\partial N_i}{\partial z}, \quad (10.59)$$

equation (10.58) can be written as

$$Z_1 + Z_2 + Z_3 = 0, \quad (10.60)$$

where

$$Z_1 = \iint_R \left\{ \frac{\partial}{\partial r} [r \sigma_{rz} N_i] + \frac{\partial}{\partial z} [r \sigma_{zz} N_i] \right\} dr dz, \quad (10.61)$$

$$Z_2 = - \iint_R \left\{ \sigma_{rz} \frac{\partial N_i}{\partial r} + \sigma_{zz} \frac{\partial N_i}{\partial z} \right\} r dr dz, \quad (10.62)$$

$$Z_3 = \iint_R \left\{ f_z N_i \right\} r dr dz. \quad (10.63)$$

Each of these integrals will be elaborated separately.

The first integral can be transformed into a surface integral by Gauss' divergence theorem. This gives, with the second of equations (10.34),

$$Z_1 = \int_S \sigma_{nz} r N_i dS = - \sum \frac{1}{2} t_z \bar{r} L, \quad (10.64)$$

where $-t_z$ is the surface stress σ_{nz} on an element side on the boundary S (a boundary segment), \bar{r} is the average value of the radial coordinate on that segment, and L is the length of the segment. The summation is over all element sides along the boundary which contain node i , and in which the displacement is not prescribed by a boundary condition. Because values of i on the boundary S_2 do not apply, only boundary segments on S_1 occur in equation (10.64) on which t_z is given. The factor $\frac{1}{2}$ occurs because the average value of the shape function N_i over a boundary segment containing node i is assumed to be $\frac{1}{2}$.

The second integral can be elaborated by substituting two of the expressions (10.43) for the total stresses into equation (10.62). This gives

$$Z_2 = \iint_R \sum_{j=1}^n \left\{ (K_l + \frac{4}{3} G_l) \frac{\partial N_i}{\partial z} \frac{\partial N_j}{\partial z} w_j + (K_l - \frac{2}{3} G_l) \frac{\partial N_i}{\partial z} \left(\frac{\partial N_j}{\partial r} + \frac{N_j}{r} \right) u_j + \right. \\ \left. G_l \frac{\partial N_i}{\partial r} \frac{\partial N_j}{\partial r} w_j + G_l \frac{\partial N_i}{\partial r} \frac{\partial N_j}{\partial z} u_j - \alpha_l \frac{\partial N_i}{\partial z} N_j p_j \right\} r dr dz. \quad (10.65)$$

The integral is over the entire area R , which can be considered as the sum of all elements, see equation (10.52). The integral (10.65) can now be written as

$$Z_2 = \sum_{l=1}^m \sum_{j=1}^n (Q_{jil} u_j + R_{ijl} w_j + T_{ijl} p_j), \quad (10.66)$$

where

$$Q_{jil} = (K_l - \frac{2}{3} G_l) \iint_{R_l} \left(\frac{\partial N_i}{\partial z} \frac{\partial N_j}{\partial r} + \frac{\partial N_i}{\partial z} \frac{N_j}{r} \right) r dr dz + G_l \iint_{R_l} \frac{\partial N_i}{\partial r} \frac{\partial N_j}{\partial z} r dr dz. \quad (10.67)$$

$$R_{ijl} = (K_l + \frac{4}{3} G_l) \iint_{R_l} \frac{\partial N_i}{\partial z} \frac{\partial N_j}{\partial z} r dr dz + G_l \iint_{R_l} \frac{\partial N_i}{\partial r} \frac{\partial N_j}{\partial r} r dr dz, \quad (10.68)$$

$$T_{ijl} = -\alpha_l \iint_{R_l} \frac{\partial N_i}{\partial z} N_j r dr dz. \quad (10.69)$$

It may be noted that the expressions (10.55) and (10.67) for Q_{ijl} are equal. This is a consequence of the symmetry of the equations of equilibrium.

The third integral consists of an integral of the body force f_z over the region R , multiplied by the shape function N_i , see equation (10.63). Only the elements which contain node i contribute to this integral, and for such elements the average value of the shape function is assumed to be $1/k$, where k is the number of nodes per element (for instance 3 or 4). Thus the integral consists of elementary contributions of the form

$$Z_3 = -F_{zi} = - \sum_{l=1}^m \frac{A_l f_z}{k}, \quad (10.70)$$

where A_l is the area of element l .

The storage equation

The storage equation (10.38) can be satisfied on the (spatial) average by requiring that

$$\iint_R \left\{ \alpha(\bar{e} - e_0) + S(\bar{p} - p_0) - \Delta t \left[\frac{\partial}{\partial r} \left(\frac{\kappa}{\mu} \frac{\partial p}{\partial r} \right) + \frac{1}{r} \frac{\kappa}{\mu} \frac{\partial p}{\partial r} + \frac{\partial}{\partial z} \left(\frac{\kappa}{\mu} \frac{\partial p}{\partial z} \right) \right] \right\} N_i r dr dz = 0. \quad (10.71)$$

This equation must be satisfied for all values of i for which the pressure p_i is not prescribed by a boundary condition.

With equations (10.40) and (10.41) the first two terms of equation (10.71) can be elaborated to

$$\iint_R [\alpha(e - e_0) + S(p - p_0)] N_i r dr dz = \sum_{l=1}^m \sum_{j=1}^n [V_{ijl}(u_j - u_{0j}) + W_{ijl}(w_j - w_{0j}) + C_{ijl}(p_j - p_{0j})], \quad (10.72)$$

where

$$V_{ijl} = \alpha_l \iint_{R_l} \left(\frac{\partial N_j}{\partial r} + \frac{N_j}{r} \right) N_i r dr dz, \quad (10.73)$$

$$W_{ijl} = \alpha_l \iint_{R_l} \frac{\partial N_j}{\partial z} N_i r dr dz, \quad (10.74)$$

$$C_{ijl} = S_l \iint_{R_l} N_i N_j r dr dz. \quad (10.75)$$

It may be noted, by comparison with equations (10.56) and (10.69) that

$$V_{ijl} = -S_{jil}, \quad (10.76)$$

$$W_{ijl} = -T_{jil}. \quad (10.77)$$

In the expression between square brackets in equation (10.71) the following identity may be used,

$$\begin{aligned} \left[\frac{\partial}{\partial r} \left(\frac{\kappa}{\mu} \frac{\partial p}{\partial r} \right) + \frac{1}{r} \frac{\kappa}{\mu} \frac{\partial p}{\partial r} + \frac{\partial}{\partial z} \left(\frac{\kappa}{\mu} \frac{\partial p}{\partial z} \right) \right] r N_i = \\ \frac{\partial}{\partial r} \left[\frac{\kappa}{\mu} \frac{\partial p}{\partial r} r N_i \right] + \frac{\partial}{\partial z} \left[\frac{\kappa}{\mu} \frac{\partial p}{\partial z} r N_i \right] - \frac{\kappa}{\mu} \frac{\partial p}{\partial r} r \frac{\partial N_i}{\partial r} - \frac{\kappa}{\mu} \frac{\partial p}{\partial z} r \frac{\partial N_i}{\partial z}. \end{aligned} \quad (10.78)$$

It follows that

$$-\iint_R \left\{ \Delta t \left[\frac{\partial}{\partial r} \left(\frac{\kappa}{\mu} \frac{\partial p}{\partial r} \right) + \frac{1}{r} \frac{\kappa}{\mu} \frac{\partial p}{\partial r} + \frac{\partial}{\partial z} \left(\frac{\kappa}{\mu} \frac{\partial p}{\partial z} \right) \right] N_i r dr dz = -\Delta t \sum_{S_4} \frac{1}{2} q r L + \Delta t \sum_{l=1}^m \sum_{j=1}^n D_{ijl} p_j, \quad (10.79)$$

where the first summation in the right hand side is over all boundary elements where the flux is prescribed, and where

$$D_{ijl} = \frac{\kappa_l}{\mu_l} \iint_{R_l} \left(\frac{\partial N_i}{\partial r} \frac{\partial N_j}{\partial r} + \frac{\partial N_i}{\partial z} \frac{\partial N_j}{\partial z} \right) r dr dz. \quad (10.80)$$

It follows that the numerical form of the storage equation (10.71) is

$$\begin{aligned} \iint_R \left\{ \alpha(e - e_0) + S(p - p_0) - \Delta t \left[\frac{\partial}{\partial r} \left(\frac{\kappa}{\mu} \frac{\partial p}{\partial r} \right) + \frac{1}{r} \frac{\kappa}{\mu} \frac{\partial p}{\partial r} + \frac{\partial}{\partial z} \left(\frac{\kappa}{\mu} \frac{\partial p}{\partial z} \right) \right] \right\} N_i r dr dz = \\ \sum_{l=1}^m \sum_{j=1}^n [V_{ijl}(u_j - u_{0j}) + W_{ijl}(v_j - v_{0j}) + C_{ijl}(p_j - p_{0j})] - \Delta t \sum_{S_4} \frac{1}{2} q L + \Delta t \sum_{l=1}^m \sum_{j=1}^n D_{ijl} p_j = 0. \end{aligned} \quad (10.81)$$

The system of equations

By adding the expressions found for R_1 , R_2 and R_3 , see equations (10.50), (10.53) and (10.57), the equation of horizontal equilibrium can be expressed as

$$\sum_{j=1}^n P_{ij}u_j + \sum_{j=1}^n Q_{ij}w_j + \sum_{j=1}^n S_{ij}p_j = F_{ri}, \quad (10.82)$$

where F_{ri} represents the total force in r -direction acting upon node i , either from a stress along the boundary, or from a body force. The matrices P_{ij} , Q_{ij} and S_{ij} are composed of a summation of the submatrices P_{ijl} , Q_{ijl} and S_{ijl} , defined in equations (10.54), (10.55) and (10.56).

The second equation is the equation of vertical equilibrium, which can be obtained by adding the expressions found for Z_1 , Z_2 and Z_3 , see (10.64), (10.66) and (10.70),

$$\sum_{j=1}^n Q_{ji}u_j + \sum_{j=1}^n R_{ij}w_j + \sum_{j=1}^n T_{ij}p_j = F_{zi}, \quad (10.83)$$

where F_{zi} is the total force in z -direction acting upon node i , either from a stress along the boundary, or from a body force. The matrices Q_{ij} , R_{ij} and T_{ij} are composed of a summation of the submatrices Q_{ijl} , R_{ijl} and T_{ijl} , defined in equations (10.55), (10.68) and (10.69).

The third equation is the storage equation, which has been given in equation (10.81). This equation can be rewritten as

$$\sum_{j=1}^n V_{ij}u_j + \sum_{j=1}^n W_{ij}v_j + \sum_{j=1}^n U_{ij}p_j = QQ_i, \quad (10.84)$$

where U_{ij} consists of contributions from all elements of the form

$$U_{ijl} = C_{ijl} + D_{ijl}\Delta t, \quad (10.85)$$

and QQ_i is composed of contributions from all elements of the form

$$QQ_{il} = \sum_{j=1}^n V_{ij}u_{0j} + \sum_{j=1}^n W_{ij}v_{0j} + \sum_{j=1}^n C_{ij}p_{0j} - \frac{1}{2}q_l\bar{r}L_l\Delta t. \quad (10.86)$$

The equations (10.82), (10.83) and (10.84) constitute a system of $3n$ equations with $3n$ variables. This system can be solved by a suitable method for solving systems of linear algebraic equations, for instance the conjugate gradient method. It must be noted that the system is ill-conditioned, especially if the pore fluid is practically incompressible and the time step is small. In that case the coefficient of p_i in equation (10.84), which is a coefficient on the main diagonal of the system matrix, is practically zero. The solution of the system of equations requires an advanced numerical solution method, such as Gaussian elimination or an iterative method, for instance Bi-CGSTAB (Van der Vorst, 1992), with a suitable preconditioner, see Barrett *et al.* (1994).

It may also be noted that the boundary conditions for the displacements and the pore pressure, have been practically ignored so far. These can easily be incorporated, however, by replacing the appropriate equations from the system of equations (10.82), (10.83) and (10.84) by equations of the type

$$i \in S_2 : \begin{cases} u_i = a_i, \\ w_i = b_i, \end{cases} \quad (10.87)$$

or

$$i \in S_3 : p_i = h_i, \quad (10.88)$$

where a_i and b_i are the given values of the displacement in a node located on the boundary S_2 , and h_i is the given value of the pore pressure in a node located on the boundary S_3 .

If the system of equations (10.82), (10.83) and (10.84) has been solved, the values of the displacements and the pore pressure after the time step have been determined. These values can be considered as the initial values for the next time step, and the process can be repeated for any number of time steps.

10.2.4 Isoparametric elements

In this section the basic equations will be elaborated for a particular type of elements: quadrangular elements, with isoparametric shape functions.

A typical quadrangular element in the r, z -plane is shown in Figure 10.3. The basic idea of isoparametric shape functions is to use a local coordinate system ξ, η , with $-1 \leq \xi \leq +1$ and $-1 \leq \eta \leq +1$. The local

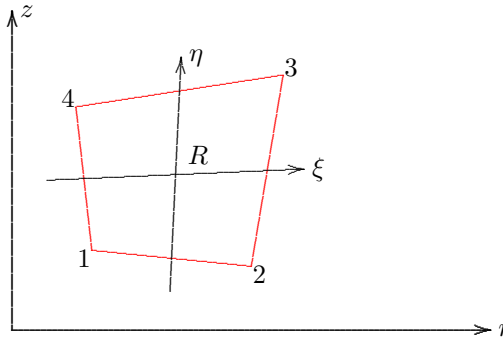

Figure 10.3: Isoparametric element.

coordinates of the four points are, for point 1 : $\xi = -1, \eta = -1$, for point 2 : $\xi = 1, \eta = -1$, for point 3 : $\xi = 1, \eta = 1$, and for point 4 : $\xi = -1, \eta = 1$.

The global coordinates r and z are interpolated in the element as

$$r = \sum_{k=1}^4 N_k r_k, \quad z = \sum_{k=1}^4 N_k z_k, \quad (10.89)$$

where

$$\begin{aligned} N_1 &= \frac{1}{4}(1 - \xi)(1 - \eta), \\ N_2 &= \frac{1}{4}(1 + \xi)(1 - \eta), \\ N_3 &= \frac{1}{4}(1 + \xi)(1 + \eta), \\ N_4 &= \frac{1}{4}(1 - \xi)(1 + \eta). \end{aligned} \quad (10.90)$$

It can immediately be seen that these equations ensure that the coordinates in node i indeed are r_i and z_i . Similarly the displacements u and w and the pore pressure p are interpolated as

$$u = \sum_{k=1}^4 N_k u_k, \quad w = \sum_{k=1}^4 N_k w_k, \quad p = \sum_{k=1}^4 N_k p_k, \quad (10.91)$$

where u_k, w_k and p_k are the values of the displacement components and the pore pressure in node k .

In the finite element method integrals of the products of N_i and N_j , or their derivatives, over an area in the r, z -plane have to be evaluated. In order to transform these integrals into integrals in the ξ, η -plane a transformation from the coordinates r and z to ξ and η must be effected. The transformation of derivatives is given by

$$\begin{vmatrix} \frac{\partial}{\partial \xi} \\ \frac{\partial}{\partial \eta} \end{vmatrix} = \mathbf{J} \begin{vmatrix} \frac{\partial}{\partial r} \\ \frac{\partial}{\partial z} \end{vmatrix}, \quad (10.92)$$

where \mathbf{J} is the transformation matrix

$$\mathbf{J} = \begin{vmatrix} \frac{\partial r}{\partial \xi} & \frac{\partial z}{\partial \xi} \\ \frac{\partial r}{\partial \eta} & \frac{\partial z}{\partial \eta} \end{vmatrix}. \quad (10.93)$$

It should be noted that the coefficients of this matrix are not constants, because the relationship between r, z and ξ, η is non-linear, so that the coefficients of the transformation matrix are functions of ξ and η . In the point $\xi = \xi_i, \eta = \eta_j$ we will write

$$\mathbf{J}_{ij} = \begin{vmatrix} \frac{\partial r}{\partial \xi} & \frac{\partial z}{\partial \xi} \\ \frac{\partial r}{\partial \eta} & \frac{\partial z}{\partial \eta} \end{vmatrix}_{\xi=\xi_i, \eta=\eta_j}. \quad (10.94)$$

The actual values of the coefficients of the transformation matrix are, using the definitions (10.89) and (10.90),

$$\begin{aligned} \frac{\partial r}{\partial \xi} &= -\frac{1}{4}(1-\eta)r_1 + \frac{1}{4}(1-\eta)r_2 + \frac{1}{4}(1+\eta)r_3 - \frac{1}{4}(1+\eta)r_4, \\ \frac{\partial z}{\partial \xi} &= -\frac{1}{4}(1-\eta)z_1 + \frac{1}{4}(1-\eta)z_2 + \frac{1}{4}(1+\eta)z_3 - \frac{1}{4}(1+\eta)z_4, \\ \frac{\partial r}{\partial \eta} &= -\frac{1}{4}(1-\xi)r_1 - \frac{1}{4}(1+\xi)r_2 + \frac{1}{4}(1+\xi)r_3 + \frac{1}{4}(1-\xi)r_4, \\ \frac{\partial z}{\partial \eta} &= -\frac{1}{4}(1-\xi)z_1 - \frac{1}{4}(1+\xi)z_2 + \frac{1}{4}(1+\xi)z_3 + \frac{1}{4}(1-\xi)z_4. \end{aligned} \quad (10.95)$$

These values can easily be calculated in any arbitrary point ξ, η . Thus the matrix \mathbf{J}_{ij} is known in every point ξ, η . Its inverse is denoted by \mathbf{J}_{ij}^{-1} , and it is defined by

$$\mathbf{J}_{ij}\mathbf{J}_{ij}^{-1} = \mathbf{I} = \begin{vmatrix} 1 & 0 \\ 0 & 1 \end{vmatrix}. \quad (10.96)$$

The coefficients of the inverse matrix can also be calculated easily, in any point ξ, η ,

$$\mathbf{J}_{ij}^{-1} = \frac{1}{\det(\mathbf{J}_{ij})} \begin{vmatrix} \frac{\partial z}{\partial \eta} & -\frac{\partial z}{\partial \xi} \\ -\frac{\partial r}{\partial \eta} & \frac{\partial r}{\partial \xi} \end{vmatrix}_{\xi=\xi_i, \eta=\eta_j}, \quad (10.97)$$

where $\det(\mathbf{J}_{ij})$ is the determinant of the matrix \mathbf{J}_{ij} ,

$$\det(\mathbf{J}_{ij}) = \frac{\partial r}{\partial \xi} \frac{\partial z}{\partial \eta} - \frac{\partial z}{\partial \xi} \frac{\partial r}{\partial \eta}. \quad (10.98)$$

The inverse matrix can also be defined as the relation inverse to equation (10.92),

$$\begin{vmatrix} \frac{\partial}{\partial r} \\ \frac{\partial}{\partial z} \end{vmatrix} = \mathbf{J}^{-1} \begin{vmatrix} \frac{\partial}{\partial \xi} \\ \frac{\partial}{\partial \eta} \end{vmatrix}, \quad (10.99)$$

where now \mathbf{J}^{-1} is the inverse transformation matrix

$$\mathbf{J}^{-1} = \begin{vmatrix} \frac{\partial \xi}{\partial r} & \frac{\partial \eta}{\partial r} \\ \frac{\partial \xi}{\partial z} & \frac{\partial \eta}{\partial z} \end{vmatrix}. \quad (10.100)$$

The derivatives of the shape functions can be calculated using the relations

$$\frac{\partial N_i}{\partial r} = \frac{\partial N_i}{\partial \xi} \frac{\partial \xi}{\partial r} + \frac{\partial N_i}{\partial \eta} \frac{\partial \eta}{\partial r} = J_{11}^{-1} \frac{\partial N_i}{\partial \xi} + J_{12}^{-1} \frac{\partial N_i}{\partial \eta}, \quad (10.101)$$

$$\frac{\partial N_i}{\partial z} = \frac{\partial N_i}{\partial \xi} \frac{\partial \xi}{\partial z} + \frac{\partial N_i}{\partial \eta} \frac{\partial \eta}{\partial z} = J_{21}^{-1} \frac{\partial N_i}{\partial \xi} + J_{22}^{-1} \frac{\partial N_i}{\partial \eta}. \quad (10.102)$$

In these expressions the derivatives $\partial N_i/\partial \xi$ and $\partial N_i/\partial \eta$ can be calculated from the definitions (10.90), and the coefficients of the matrix \mathbf{J}^{-1} can be determined from equation (10.97).

The various integrals needed to calculate the coefficients in the finite element equations can now be expressed into integrals over ξ and η as

$$p_{ij}^1 = \iint_{R_i} \frac{\partial N_i}{\partial r} \frac{\partial N_j}{\partial r} r dr dz = \iint_{R_i} \frac{\partial N_i}{\partial r} \frac{\partial N_j}{\partial r} \det(\mathbf{J}_{ij}) r d\xi d\eta, \quad (10.103)$$

$$p_{ij}^2 = \iint_{R_i} \frac{\partial N_i}{\partial z} \frac{\partial N_j}{\partial z} r dr dz = \iint_{R_i} \frac{\partial N_i}{\partial z} \frac{\partial N_j}{\partial z} \det(\mathbf{J}_{ij}) r d\xi d\eta, \quad (10.104)$$

$$p_{ij}^3 = \iint_{R_i} \frac{N_i}{r} \frac{N_j}{r} r dr dz = \iint_{R_i} \frac{N_i N_j}{r} \det(\mathbf{J}_{ij}) d\xi d\eta, \quad (10.105)$$

$$p_{ij}^4 = \iint_{R_i} \frac{\partial N_i}{\partial r} \frac{N_j}{r} r dr dz = \iint_{R_i} \frac{\partial N_i}{\partial r} N_j \det(\mathbf{J}_{ij}) d\xi d\eta, \quad (10.106)$$

$$p_{ij}^5 = \iint_{R_i} \frac{N_i}{r} \frac{\partial N_j}{\partial r} r dr dz = \iint_{R_i} \frac{\partial N_j}{\partial r} N_i \det(\mathbf{J}_{ij}) d\xi d\eta, \quad (10.107)$$

$$q_{ij}^1 = \iint_{R_i} \frac{\partial N_i}{\partial r} \frac{\partial N_j}{\partial z} r dr dz = \iint_{R_i} \frac{\partial N_i}{\partial r} \frac{\partial N_j}{\partial z} \det(\mathbf{J}_{ij}) r d\xi d\eta, \quad (10.108)$$

$$q_{ij}^2 = \iint_{R_i} \frac{\partial N_i}{\partial z} \frac{\partial N_j}{\partial r} r dr dz = \iint_{R_i} \frac{\partial N_i}{\partial z} \frac{\partial N_j}{\partial r} \det(\mathbf{J}_{ij}) r d\xi d\eta, \quad (10.109)$$

$$q_{ij}^3 = \iint_{R_i} \frac{N_i}{r} \frac{\partial N_j}{\partial z} r dr dz = \iint_{R_i} N_i \frac{\partial N_j}{\partial z} \det(\mathbf{J}_{ij}) d\xi d\eta, \quad (10.110)$$

$$s_{ij}^1 = \iint_{R_i} \frac{\partial N_i}{\partial r} N_j r dr dz = \iint_{R_i} \frac{\partial N_i}{\partial r} N_j \det(\mathbf{J}_{ij}) r d\xi d\eta. \quad (10.111)$$

$$s_{ij}^2 = \iint_{R_i} N_i N_j dr dz = \iint_{R_i} N_i N_j \det(\mathbf{J}_{ij}) d\xi d\eta. \quad (10.112)$$

$$t_{ij}^1 = \iint_{R_i} \frac{\partial N_i}{\partial z} N_j r dr dz = \iint_{R_i} \frac{\partial N_i}{\partial z} N_j \det(\mathbf{J}_{ij}) r d\xi d\eta, \quad (10.113)$$

$$c_{ij}^1 = \iint_{R_i} N_i N_j r dr dz = \iint_{R_i} N_i N_j \det(\mathbf{J}_{ij}) r d\xi d\eta, \quad (10.114)$$

$$d_{ij}^1 = p_{ij}^1 + p_{ij}^2. \quad (10.115)$$

All the integrals in the right hand sides of these equations can be calculated numerically by adding the values in the four Gaussian points $\xi = \pm a, \eta = \pm a$, where $a = 1/\sqrt{3} = 0.5773503$. The value of r in a Gauss point should be calculated using the first of equations (10.89)

$$r = \sum_{k=1}^4 N_k r_k. \quad (10.116)$$

Using the expressions (10.103)–(10.115) the submatrices needed to determine the system of equations can be written as

$$P_{ijl} = (K_l + \frac{4}{3}G_l)(p_{ij}^1 + p_{ij}^3) + (K_l - \frac{2}{3}G_l)(p_{ij}^4 + p_{ij}^5) + G_l p_{ij}^2, \quad (10.117)$$

$$Q_{ijl} = (K_l - \frac{2}{3}G_l)(q_{ij}^1 + q_{ij}^3) + G_l q_{ij}^2, \quad (10.118)$$

$$S_{ijl} = -V_{jil} = -\alpha_l (s_{ij}^1 + s_{ij}^2), \quad (10.119)$$

$$R_{ijl} = (K_l + \frac{4}{3}G_l)p_{ij}^2 + G_l p_{ij}^1, \quad (10.120)$$

$$T_{ijl} = -W_{jil} = -\alpha_l t_{ij}^1, \quad (10.121)$$

$$U_{ijl} = S_l c_{ij}^1 + \epsilon \Delta t \frac{\kappa_l}{\mu_l} d_{ij}^1. \quad (10.122)$$

The nodal forces F_{ri} and F_{zi} in equations (10.82) and (10.83), acting in node i , can be calculated by integrating the distributed body forces in the elements over these elements, see equations (10.57) and (10.70). For element k the components of the total force are

$$F_{rk} = \iint_{R_k} f_{rk} r dr dz, \quad (10.123)$$

$$F_{zk} = \iint_{R_k} f_{zk} r dr dz, \quad (10.124)$$

where f_{rk} and f_{zk} are the body forces in element k , in r - and z -directions. The forces must be distributed over the nodes of element k , each node obtaining $\frac{1}{4}$ of the total force, because the elements are quadrangles.

In terms of the isoparametric coordinates the expressions (10.123) and (10.124) become, assuming that the body forces are constant in the element considered,

$$F_{rk} = f_{rk} \iint_{R_k} \det(\mathbf{J}_{ij}) r d\xi d\eta, \quad (10.125)$$

$$F_{zk} = f_{zk} \iint_{R_k} \det(\mathbf{J}_{ij}) r d\xi d\eta. \quad (10.126)$$

The integrals represent the radial moment of element k , which can most conveniently be calculated by summing the values of $\det(\mathbf{J}_{ij}) r$ in the four Gauss points.

10.2.5 Stresses

The effective stresses can be expressed in the displacements by Hooke's law. For an isotropic material this is, see equations (10.9),

$$\begin{aligned} \sigma'_{rr} &= -(K - \frac{2}{3}G)e - 2G\varepsilon_{rr} = -(K - \frac{2}{3}G)e - 2G\frac{\partial u}{\partial r}, \\ \sigma'_{tt} &= -(K - \frac{2}{3}G)e - 2G\varepsilon_{tt} = -(K - \frac{2}{3}G)e - 2G\frac{u}{r}, \\ \sigma'_{zz} &= -(K - \frac{2}{3}G)e - 2G\varepsilon_{zz} = -(K - \frac{2}{3}G)e - 2G\frac{\partial w}{\partial z}, \\ \sigma'_{rz} &= -2G\varepsilon_{rz} = -G\left(\frac{\partial u}{\partial z} + \frac{\partial w}{\partial r}\right). \end{aligned} \quad (10.127)$$

where K and G are the compression modulus and the shear modulus, respectively.

In a typical element the displacements can be expressed by the first two of equations (10.91),

$$u = \sum_{k=1}^4 N_k u_k, \quad w = \sum_{k=1}^4 N_k w_k. \quad (10.128)$$

As in equations (10.42) the stresses in an element can be expressed as

$$\begin{aligned}
\sigma'_{rr} &= -(K + \frac{4}{3}G) \sum_{i=1}^4 \frac{\partial N_i}{\partial r} u_i - (K - \frac{2}{3}G) \sum_{i=1}^n \left(N_i \frac{u_i}{r} + \frac{\partial N_i}{\partial z} w_i \right), \\
\sigma'_{tt} &= -(K + \frac{4}{3}G) \sum_{i=1}^4 N_i \frac{u_i}{r} - (K - \frac{2}{3}G) \sum_{i=1}^n \left(\frac{\partial N_i}{\partial r} u_i + \frac{\partial N_i}{\partial z} w_i \right), \\
\sigma'_{zz} &= -(K + \frac{4}{3}G) \sum_{i=1}^4 \frac{\partial N_i}{\partial z} w_i - (K - \frac{2}{3}G) \sum_{i=1}^n \left(\frac{\partial N_i}{\partial r} u_i + N_i \frac{u_i}{r} \right), \\
\sigma'_{rz} &= -G \sum_{i=1}^4 \frac{\partial N_i}{\partial z} u_i - G \sum_{i=1}^n \frac{\partial N_i}{\partial r} w_i.
\end{aligned} \tag{10.129}$$

The stresses are a function of x and z , or of ξ and η . Unlike the displacements, the stresses are in general not continuous in the nodal points, not even if the material properties are constant. It seems practical to consider the average stress in an element as representative. These average stresses can be calculated by taking the average of the values in the four Gauss points.

10.2.6 Undrained response

It is sometimes desirable or convenient to calculate the immediate response of a poroelastic medium to a sudden load, ignoring all drainage. The time-dependent consolidation of the medium may follow this initial behaviour. The determination of the immediate (*undrained*) response might be attempted by considering the system of equations with a time step of zero magnitude, $\Delta t = 0$. In that case, however, the system of equations degenerates, and becomes ill-conditioned. A special approach may be followed to investigate this undrained behaviour.

It is recalled, from (10.1), (10.4) and (10.5) that the basic differential equations for axially symmetric poroelasticity are

$$\alpha \frac{\partial e}{\partial t} + S \frac{\partial p}{\partial t} - \frac{\partial}{\partial r} \left(\frac{\kappa}{\mu} \frac{\partial p}{\partial r} \right) - \frac{1}{r} \frac{\kappa}{\mu} \frac{\partial p}{\partial r} - \frac{\partial}{\partial z} \left(\frac{\kappa}{\mu} \frac{\partial p}{\partial z} \right) = 0, \tag{10.130}$$

$$\frac{\partial \sigma_{rr}}{\partial r} + \frac{\sigma_{rr} - \sigma_{tt}}{r} + \frac{\partial \sigma_{zr}}{\partial z} - f(r) = 0, \tag{10.131}$$

$$\frac{\partial \sigma_{rz}}{\partial r} + \frac{\sigma_{rz}}{r} + \frac{\partial \sigma_{zz}}{\partial z} - f(z) = 0. \tag{10.132}$$

The total stresses can be related to the displacements and the pore pressure through the equations (10.14),

$$\begin{aligned}
\sigma_{rr} &= -(K - \frac{2}{3}G)e - 2G \frac{\partial u}{\partial r} + \alpha p, \\
\sigma_{tt} &= -(K - \frac{2}{3}G)e - 2G \frac{u}{r} + \alpha p, \\
\sigma_{zz} &= -(K - \frac{2}{3}G)e - 2G \frac{\partial w}{\partial z} + \alpha p, \\
\sigma_{rz} &= -G \left(\frac{\partial u}{\partial z} + \frac{\partial w}{\partial r} \right).
\end{aligned} \tag{10.133}$$

By integrating the storage equation (10.130) over a very small time step Δt , and assuming that the divergence of the specific discharge vector, expressed by the last three terms in equation (10.130), is finite, it follows, assuming that the initial values of the volume strain e and the pore pressure p are zero, that

$$\alpha e + Sp = 0. \tag{10.134}$$

If the storativity $S = 0$ this means that the material is incompressible, $e = 0$. Assuming that the storativity is perhaps very small but unequal to zero, $S > 0$, it follows that

$$p = -\alpha e / S. \tag{10.135}$$

Using this relation the total stresses can be expressed as

$$\begin{aligned}
 \sigma_{rr} &= -(K_u - \frac{2}{3}G)e - 2G\frac{\partial u}{\partial r}, \\
 \sigma_{tt} &= -(K_u - \frac{2}{3}G)e - 2G\frac{u}{r}, \\
 \sigma_{zz} &= -(K_u - \frac{2}{3}G)e - 2G\frac{\partial w}{\partial z}, \\
 \sigma_{rz} &= -G\left(\frac{\partial u}{\partial z} + \frac{\partial w}{\partial r}\right),
 \end{aligned}
 \tag{10.136}$$

where

$$K_u = K + \alpha^2/S, \tag{10.137}$$

the *undrained compression modulus*.

Because the equations of equilibrium can be expressed completely in terms of the total stresses, and the boundary conditions for the porous medium are expressed in terms of the total stresses or the displacements, see equations (10.19) and (10.20), it follows that the initial response at time $t = 0$, the moment of loading, can be determined as the solution of a problem of elasticity, for a material with shear modulus G and compression modulus K_u . In the special case that the solid particles and the pore fluid are both incompressible the storativity $S = 0$, see equation (10.3), and then the undrained porous material is incompressible, $K_u \rightarrow \infty$. In that case the response may be very difficult or impossible to determine, because the system of equations degenerates. A good approximation of the undrained response may be determined, however, by introducing a small compressibility for the pore fluid, so that the order of magnitude of the factor α^2/S is large compared to the drained compression modulus K , but not infinitely large, say $\alpha^2/S = 100 * K$.

For the analysis of the undrained response the system of equations (10.82), (10.83) and (10.84) can be used in its original form, but the matrices S_{ij} and T_{ij} should be ignored (meaning that their values should be set to zero), and the matrix U_{ij} should be restricted to the contribution C_{ij} . In the matrices P_{ij} , Q_{ij} and R_{ij} the compression modulus should be taken as K_u , see equation (10.137).

Another, and perhaps simpler, approach is to let the original computer program find the undrained solution, by setting all the boundary conditions for the pore pressure as impermeable, and assuming a small time step in which the undrained response may be calculated. The value of time after that initial time step can be reset to zero, before the progress of the consolidation process is calculated, using the actual boundary conditions for the pore pressure.

10.3 Computer program

A computer program, POROFAX, to solve the system of equations (10.82), (10.83) and (10.84) has been developed, using Borland's C++ Builder. These equations are

$$\sum_{j=1}^n P_{ij}\bar{u}_j + \sum_{j=1}^n Q_{ij}\bar{w}_j + \sum_{j=1}^n S_{ij}\bar{p}_j = F_r^i, \tag{10.138}$$

$$\sum_{j=1}^n Q_{ji}\bar{u}_j + \sum_{j=1}^n R_{ij}\bar{w}_j + \sum_{j=1}^n T_{ij}\bar{p}_j = F_z^i, \tag{10.139}$$

$$\sum_{j=1}^n V_{ij}\bar{u}_j + \sum_{j=1}^n W_{ij}\bar{w}_j + \sum_{j=1}^n U_{ij}\bar{p}_j = QQ_i. \tag{10.140}$$

The system of equations is solved by an iterative method, Bi-CGSTAB (Van der Vorst, 1992). To accelerate the convergence of the solution a modified Jacobi preconditioner is used, in which all equations are normalized by division by its largest coefficient. In the first two equations the largest coefficient usually is the term on the main diagonal, but in the third equation the term on the main diagonal may be very small, indicating that the system may be ill-conditioned. Iterations should continue until the residue (the sum of the squares of the components of the error vector) is smaller than a given number, for instance 10^{-24} , 10^{-36} or 10^{-48} . Experience has shown that the solution is most stable and most accurate if the parameter ϵ is taken as $\epsilon = 1$, indicating backward interpolation, but the program will also give good results for smaller values of ϵ , provided that $\epsilon > 0.5$ to ensure stability (Booker & Small, 1974).

Time steps

In order to ensure numerical stability the magnitude of the time steps should be taken not too large, and their magnitude may be increased gradually when consolidation progresses. However, the first time step should not be taken too small either to avoid inaccuracies (Vermeer & Verruijt, 1981). This sensitivity is a consequence of the approximation of the basic variables by linear shape functions, which requires that in a single time step the consolidation process in an element must have been completed. Reasonable convergence can be obtained if the duration of the entire consolidation process can be estimated, and then taking 20 or 50, or perhaps more time steps of equal magnitude to describe the process. To obtain sufficient accuracy it is recommended to use a first time step such that in all of the elements the consolidation process has progressed up to say $ct/\ell^2 = 2$, where c is the local consolidation coefficient and ℓ is a characteristic element size, for instance such that $A = \ell^2$, where A is the area of the element. This means that the magnitude of this first time step is determined by the element in which consolidation is the slowest. In the program POROFAX the magnitude of the time to complete the process of consolidation must be given by the user as the input value CT in the grid of parameters, on the basis of an initial estimate, which may be modified if the results indicate that this initial estimate is too small or too large. Intermediate time steps can be taken of equal magnitude, as $DT = CT/NT$, where NT is the number of time steps. If desired the time steps can be taken in a more refined way by prescribing the values of time (in the screen "Times") in ratios such as 1:2:3:5:7:10:20:30:50:70:100, etc. However, best results are usually obtained by taking time steps of constant (small) magnitude, at the cost of computation time, of course.

The program will store output data for a number of values of time (NT) prescribed by the user (in the screen "Times"). These output data are stored in the files "Data.1", "Data2", etc., if "Data.px4" is the datafile containing the input data of the problem considered. The procedure is such that in the program each interval between subsequent output values of time may be subdivided into a number of subintervals (NS), say $NS=2$ or $NS=4$, in order to obtain sufficient accuracy, without storing too many output data.

The initial state is determined in a separate undrained analysis, in which all boundaries are impermeable, and a time step is used equal to one-half of the first output step. The results of this undrained analysis are stored in the file "Data.0".

The type of problems solved by the program are for a soil mass which is in equilibrium at time $t = 0$, and is loaded at that moment by some external loads, which remain constant in time. As mentioned before, the initial response is calculated using an initial small time step, in which the undrained response can be calculated, using the boundary conditions for the displacements and the total stresses, but ignoring the given pore pressures on a boundary. Because the pore pressure in each node must be determined from the local volume strain, and this is not defined in the nodes, but must be determined on the average, it is most convenient to use a lumping procedure in the matrix C_{ij} , in which all non-zero terms involving the pore pressure are lumped together on the main diagonal. Ignoring the boundary conditions for the pore pressure implies that the pore pressure along such boundaries will not be zero, as the boundary is considered as an impermeable boundary. In the next time step (the first non-zero time step) the pore pressure along such a boundary shows a sudden jump, as it jumps to the zero value prescribed by the boundary condition. This is in agreement with the usual approach in analytical solution methods. For instance, in Terzaghi's problem of one-dimensional consolidation of a soil sample, the initial pore pressure is considered to be constant, up to the drained boundary, and then for $t > 0$ the pore pressure at the drained boundary is set equal to zero.

For the time steps after the initial undrained step the storage equation may give rise to instabilities, especially if the compressibility of the fluid and the particles are very small. Therefore the program uses a solution in two cycles of iterations, with a physical *preconditioner* in the first cycle.

Rendulic preconditioner

For the time steps after the initial undrained step the storage equation may give rise to instabilities, especially if the compressibility of the fluid and the particles are very small. Therefore the program uses a solution in two cycles of iterations, with a physical *preconditioner* in the first cycle. A first possibility is to use the uncoupling method first suggested by Rendulic (1936). In this approach the system of equations is simplified in a first computation cycle by assuming that the isotropic total stress remains constant in the time step considered. In general the volume change can be expressed as

$$\frac{\partial \varepsilon}{\partial t} = -C_m \frac{\partial(\sigma - \alpha p)}{\partial t}, \quad (10.141)$$

where σ is the isotropic total stress. If this quantity is assumed to be constant in time, as a first approximation, it follows that

$$\frac{\partial \varepsilon}{\partial t} = \alpha C_m \frac{\partial p}{\partial t}, \quad (10.142)$$

so that the storage equation (10.1) reduces to

$$(\alpha C_m + S) \frac{\partial p}{\partial t} - \frac{\partial}{\partial r} \left(\frac{\kappa}{\mu} \frac{\partial p}{\partial r} \right) - \frac{1}{r} \frac{\kappa}{\mu} \frac{\partial p}{\partial r} - \frac{\partial}{\partial z} \left(\frac{\kappa}{\mu} \frac{\partial p}{\partial z} \right) = 0. \quad (10.143)$$

This is an equation of the diffusion type, in which the coefficient of $\partial p / \partial t$ is never small, because of the factor αC_m , which involves the compressibility of the soil. The system of equations now is uncoupled, and is not ill-conditioned, which makes it easier to obtain convergence.

Lateral confinement preconditioner

A second possibility for a physical preconditioner is to assume, as a first approximation, that the horizontal deformations are negligible. This seems especially justified in the case of vertical loads only, with some lateral confinement at the boundaries. This means that the volume change consists of the vertical strain only,

$$e = \varepsilon_{zz}. \quad (10.144)$$

For a linear elastic material the vertical strain can be related to the vertical effective stress,

$$e = \varepsilon_{zz} = -m_v \sigma'_{zz} = -m_v (\sigma_{zz} - \alpha p), \quad (10.145)$$

where the vertical compressibility m_v can be expressed as

$$m_v = 1 / (K + \frac{4}{3}G), \quad (10.146)$$

see the second of equations (10.9).

It now follows that

$$\frac{\partial e}{\partial t} = -m_v \frac{\partial \sigma_{zz}}{\partial t} + \alpha m_v \frac{\partial p}{\partial t}. \quad (10.147)$$

The storage equation (10.1) now reduces to

$$(\alpha^2 m_v + S) \frac{\partial p}{\partial t} = \alpha m_v \frac{\partial \sigma_{zz}}{\partial t} + \frac{\partial}{\partial r} \left(\frac{\kappa}{\mu} \frac{\partial p}{\partial r} \right) + \frac{1}{r} \frac{\kappa}{\mu} \frac{\partial p}{\partial r} + \frac{\partial}{\partial z} \left(\frac{\kappa}{\mu} \frac{\partial p}{\partial z} \right). \quad (10.148)$$

If the vertical total stress σ_{zz} is assumed to be constant in time this is an equation of the diffusion type, in which the coefficient of $\partial p / \partial t$ is never small, because of the factor $\alpha^2 m_v$, which involves the vertical compressibility of the soil. The system of equations now is again uncoupled, and is not ill-conditioned, which makes it easier to obtain convergence.

The two cycles of computation

The results of a first cycle of uncoupled computations may be used as a first estimate for the second cycle, in which the full coupled system of equations is solved. Some examples will be presented in the next section. In all examples Rendulic's approximation is used in the first cycle.

10.3.1 Examples

In this section some examples of the application of the program POROFAX are presented.

Example 101, Terzaghi's problem

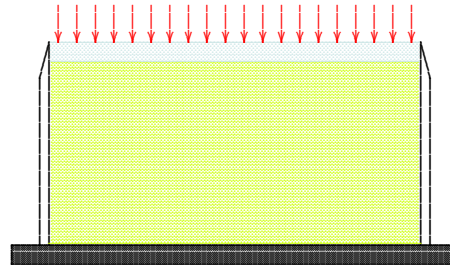

Figure 10.4: Terzaghi's problem.

The first example, the data of which are contained in the file Example101.px4, is the case of one-dimensional consolidation of a layer of thickness $h = 1$ m and radius $r = 1$ m, Terzaghi's classical problem, see Figure 10.4. This example is for a massive cylinder, with the surface of the cylinder being impermeable, and drainage at the top only. The analytical solution of this problem has been given in section 2.2, see Figure 2.3.

In the finite element solution using the program POROFAX the load is applied in the boundary sections between the nodes 7 ($r = 0, z = 1$) and 8 ($r = 0.5, z = 1$) and between the nodes 8 and 9 ($r = 1, z = 1$). The magnitude of the load on each of these two sections is $T_z = -1$ kN/m². In the computer program the loads are transferred to the nodes located on the two given boundary sections.

A comparison of the analytical solution and the results of the finite element computations is shown in Figure 10.5. The pore pressures for $c_v t/h^2 = 0.1, 0.2, 0.3, 0.4, 0.5$ and 1.0 are shown by black lines. The red

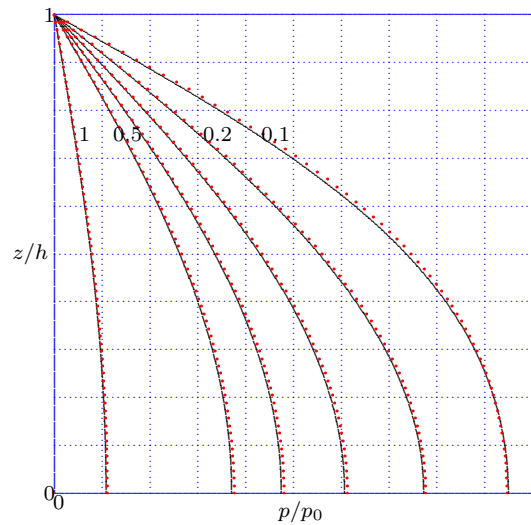

Figure 10.5: Example 101, Pore pressure as a function of z/h and $c_v t/h^2$.

dots indicate the results of the finite element calculations. The agreement appears to be excellent.

It should be noted that in section 2.2 a comparison has already been shown of the analytical solution and a numerical solution using finite differences, see Figure 2.4. The numerical method used in this chapter is much more powerful, however, because it is two-dimensional, and allows for variable properties of the soil in the elements.

Example 102, De Leeuw's problem

The second example concerns a massive cylinder of height 1 m and radius 1 m. The vertical displacements are zero at the bottom and the top, and a constant radial load is applied at the outer boundary. Drainage occurs only at this radial surface. This is De Leeuw's problem, considered in section 3.4, where the analytical solution has been given. The initial mesh consists of 4 blocks, with 9 nodes. The nodes 1, 4 and 7 are located on the axis of symmetry ($r = 0$), and the nodes 3, 6 and 9 are located on the boundary ($r = 1$). The mesh of finite elements is constructed by the computer program, by several cycles of refinement of the initial mesh, leading to a mesh of 4096 elements and 4225 nodes.

In this case the radial load is applied in the boundary sections between the nodes 3 ($r = 1, z = 0$) and 6 ($r = 1, z = 0.5$) and between the nodes 6 and 9 ($r = 1, z = 1$). The magnitude of the load on each of these two sections is $T_r = -1 \text{ kN/m}^2$. The computer program takes care that the loads are distributed over the nodes located on the two given boundary sections between nodes 3 and 6 and between nodes 6 and 9.

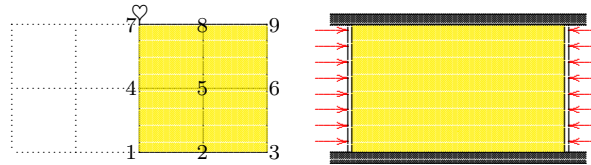

Figure 10.6: Cylindrical sample, with radial load.

The solution is shown in Figure 10.7. The black lines indicate the analytical solution, which was already shown in Figure 3.10, and the red dots indicate the results of the finite element calculations. It may be observed that the Mandel-Cryer effect, with the overshoot of the pore pressure in the center of the sample for small values of time, is correctly obtained in both solutions.

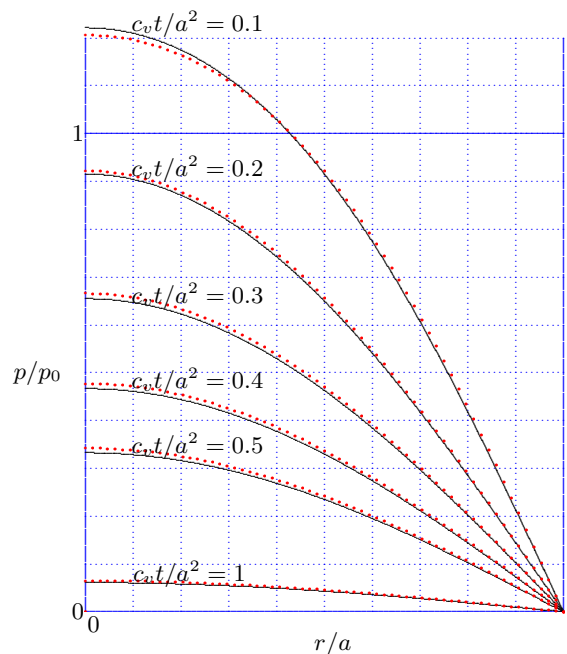

Figure 10.7: Example 10-2, De Leeuw's problem : Pore pressures.

Example 103, Well in a finite aquifer, Theis-Jacob model

The third example is the finite element analysis of the problem considered in section 5.4 of the flow to a well in a confined aquifer of finite radius, using the Theis-Jacob model, see Figure 10.8. The problem refers to an

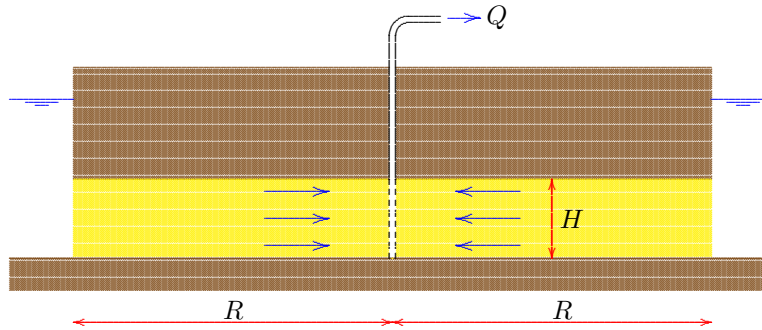

Figure 10.8: A well in a circular confined aquifer, Theis-Jacob model.

aquifer of radius $R = 300$ m, and thickness $H = 10$ m. The properties of the soil are such that the permeability is $k = 1$ m/d and the coefficient of consolidation is $c_v = 100$ m²/d. The pore pressures are shown for $t = 10$ d, $t = 100$ d and $t = 1000$ d. The results are shown in Figure 10.9 by black dots. The solution derived in section 5.4, and also given in Figure 5.8, is represented by the solid red lines. The agreement appears to be excellent. The dataset is given in the file Example103.px4. In this case the input of the discharge of the well

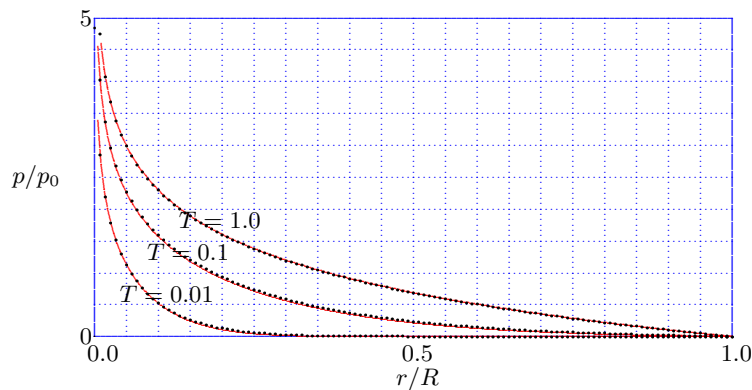

Figure 10.9: Well in finite aquifer : Pore pressure p , for $t = 10, 100, 1000$ d.

is defined by the given discharge at the line between the nodes 1 and 32, which are located at the axis $r = 0$. In order to compare the output data with the results obtained in section 5.4 the total discharge of the well is $Q = 2\pi k H p_0 / \gamma_f = 6.28$ m³/d, assuming that $p_0 = 1$ kN/m², so that the pore pressures in the output data are expressed in kN/m².

In order to determine the range of values for the time steps it may be assumed that consolidation will be completed if the value of the dimensionless time parameter $c_v t / R^2$ is about 1. This means that the maximum time is about $t = 900$ d. This suggests that the first time step may be about 1 d.

Example 104, Well in a finite aquifer, Plane stress model

The fourth example is the finite element analysis of the problem considered in section 5.5 of the flow to a well in a confined aquifer of finite radius, using the plane stress model. As in the previous example, the radius of the aquifer is $R = 300$ m, and its thickness is $H = 10$ m. The properties of the soil are such that the permeability is $k = 1$ m/d and the coefficient of consolidation is $c'_v = 100$ m²/d. In this case the boundary at $r = R$ is free, so that it can show a radial displacement. The horizontal displacements are shown for $t = 10$ d, $t = 100$ d and $t = 1000$ d in Figure 10.10 by black dots. The solution derived in section 5.5, and also given in Figure 5.15, is represented by the solid red lines. Again the agreement appears to be very good. The

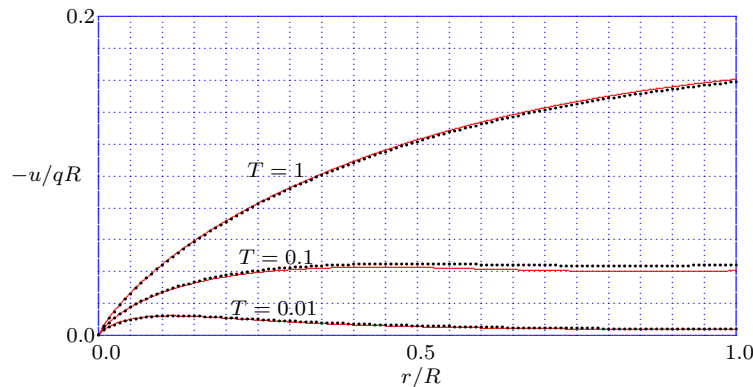

Figure 10.10: Example 4 : Horizontal displacement for $t = 10, 100, 1000$ d.

dataset is given in the file Example104.px4. In this case the input of the discharge of the well is defined by the given discharge at the line between the nodes 1 and 32, which are located at the axis $r = 0$. In order to compare the output data with the results obtained in section 5.5 the total discharge of the well is taken as $Q = 10\pi = 31.4159$ m³/d. This means that the dimensionless variable q is $q = Q\gamma_f / \{\pi k H (K + \frac{1}{3}G)\} = 0.01$, so that $qR = 3$ m. In Figure 5.15 the total height is 150 units, which corresponds to $u/qR = 0.2$. In the figures generated by the program POROFAX the height is 10 units. In order to transfer a figure to the scale of Figure 5.15 the data must be multiplied by a scale factor $10 \cdot 0.2 \cdot 3 / 150 = 0.04$. This leads to the data shown in Figure 10.10.

In order to determine the range of values for the time steps it has been assumed that consolidation will be completed if the value of the dimensionless time parameter $c'_v t / R^2$ is about 1. This means that the maximum time is about $t = 900$ d, from which it follows that the first time step should be about 1 d.

Example 105, The Noordbergum effect

In 1955 the Chief Hydrologist of the Institute of Drinking-water Supply of The Netherlands, Ir. Gerard Santing, presented a paper on "A remarkable geohydrologic phenomenon at Noordbergum" to an informal group of hydrologists (Santing, 1955). The phenomenon had been observed at a groundwater pumping station near Noordbergum, a village in the North of The Netherlands, where water was extracted from a rather deep and thick aquifer for the area of Leeuwarden, the main city of the province of Frisia. It had been observed that when the pumping of water stopped for a certain period of time, the groundwater level in the aquifer rapidly increased, as expected, but in another soil layer, above the aquifer, and separated from it by a clay layer, the water level decreased for a period of time, and later increased to its original level. A similar effect was observed when pumping resumed: the water level in the pumped aquifer immediately started to decrease, but in the overlying layers the groundwater level increased for some time (up to several hours) before it ultimately decreased to its original level. At that time no satisfactory explanation of the phenomenon, which was termed the "Noordbergum effect", existed, except that it was suspected that it was in some way caused by the elasticity of the soil. A decade later, when the Mandel-Cryer effect became known as a consequence of the three-dimensional consolidation theory of Biot (1941), it was believed that the Noordbergum effect probably was of a similar nature, but a quantitative description could not be given. A first attempt was presented by Verruijt (1969), but this gave hardly any effect, whereas in the field unexpected risings of about 0.1 m were observed. The real breakthrough came when Wolff (1970), Verruijt (1970) and Gambolati (1974) argued that the usual approach to the analysis of the flow in pumped aquifers was at variance with theoretical

and experimental evidence. In the classical approach, as developed by Theis (1935) and Jacob (1940), it is assumed that the horizontal displacements in a pumped aquifer can be disregarded. Theoretically, this is hard to accept because the flow in the aquifer is predominantly horizontal, and this flow is governed by Darcy's law, which is based on the friction between the flowing water and the soil particles. And where there are horizontal forces there must be horizontal deformations. This was confirmed by careful measurements of horizontal strains in the vicinity of wells, both when stopping the well as when starting it (Wolff, 1970).

Since then there have been numerical simulations of the effect, for instance by Rodrigues (1983), Kim & Parizek (1997) and Ferronato *et al.* (2010).

The program POROFAX can be used to demonstrate the Noordbergum effect, in Example105. In this example a system is considered of two aquifers of 10 m thickness, with a well pumping in the lower layer. The two aquifers are separated by an aquiclude of low permeability (1/10000 of the permeability in the aquifers). The radius of the layers is 300 m, and the boundary conditions are that the boundary $r = R$ is free, the boundary $r = 0$ is fixed radially, the bottom of the lowest layer is fixed in vertical direction, and the top of the upper layer is free of stress. It can be expected that the flow in the lower layer will lead to considerable radial displacements, as in Example104, and thus a Noordbergum effect may be generated in the upper layer. The mesh of finite elements is shown in Figure 10.11. The results for the pore pressure in the upper layer are

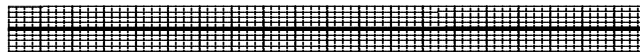

Figure 10.11: The mesh of blocks and elements.

shown in Figure 10.12, and the results for the pore pressures in the lower layer are shown in Figure 10.13. For this problem the number of blocks is 60, and each block has been refined twice by subdividing them in 4 smaller elements, so that the number of elements is 960. It can be observed that the pore pressures



Figure 10.12: Pore pressure p at $z = 15$ m, $t = 10, 30, 100$ d, scale=2.

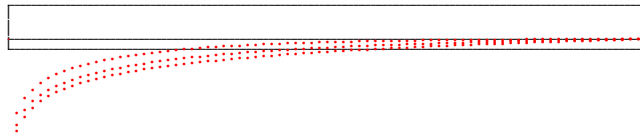

Figure 10.13: Pore pressure p at $z = 5$ m, $t = 10, 30, 100$ d, scale=0.2.

in the lower layer rapidly decrease with time, indicating a continuous lowering of the groundwater level. In the upper layer the pore pressures initially increase, and gradually decrease, confirming the Noordbergum effect. The blue dots indicate positive values, and the red dots indicate negative values. In Figure 10.13 the calculated values have been multiplied by a scale factor 0.2, and in Figure 10.12 the calculated values have been multiplied by a scale factor 2. This means that in the upper layer the changes in pore pressure are at least a factor 10 smaller than those in the lower layer. This is in agreement with the original observations in Noordbergum (Santing, 1955).

Appendix A

LAPLACE TRANSFORMS

This appendix presents a general procedure to determine inverse Laplace transforms and the derivation of some Laplace transforms used in the text. For the theory of the Laplace transform see Carslaw & Jaeger (1948) and Churchill (1972).

A.1 Talbot's method

A powerful and accurate method for numerical inversion of Laplace transforms was developed by Talbot (1979). The method is based upon a deformation of the integration path of the Bromwich inversion integral in the complex s -plane.

If the Laplace transform of a (real) function $F(t)$ is denoted by $f(s)$, the algorithm for the computation of an approximation $F(t, M)$ using Talbot's method is (Abate & Whitt, 2006)

$$F(t, M) \approx \frac{2}{5t} \sum_{k=0}^{M-1} \Re\{\gamma_k f(\delta_k/t)\}, \quad (\text{A.1})$$

where M is an integer indicating the number of terms in the approximation (e.g. $M = 10$ or $M = 20$), and where

$$\delta_0 = \frac{2M}{5}, \quad \delta_k = \frac{2k\pi}{5} [\cot(k\pi/M) + i], \quad 0 < k < M, \quad (\text{A.2})$$

$$\gamma_0 = \frac{\exp(\delta_0)}{2}, \quad \gamma_k = \left\{ 1 + i(k\pi/M)(1 + [\cot(k\pi/M)]^2) - i \cot(k\pi/M) \right\} \exp(\delta_k), \quad 0 < k < M. \quad (\text{A.3})$$

It may be noted that for $k > 0$ the coefficients δ_k and γ_k are complex. This means that the values of the Laplace transform parameter δ_k/t appearing in equation (A.1) are also complex.

In this book Talbot's method is used to obtain inverse Laplace transforms in many sections. In several places it can be compared with an analytical solution, for instance in Figure 3.6 for the solution of Cryer's problem. Other comparisons are shown in Figures 6.13 and 6.14 and in Figures 8.16 and 8.17. In all these cases the agreement between the analytical solution and the numerical solution using Talbot's method is excellent, which gives confidence in the accuracy of the numerical solution.

A.2 Some Laplace transforms used in Chapter 5

Equation (5.6.12) in the tables by Erdélyi *et al.* (1954) states that a pair of a Laplace transform and its inverse is

$$f(s) = \frac{\exp(-k\sqrt{s})}{a + \sqrt{s}}, \quad (\text{A.4})$$

$$F(t) = \frac{\exp(-k^2/4t)}{\sqrt{\pi t}} - a \exp(a^2 t + ka) [1 - \operatorname{erf}(a\sqrt{t} + k/\sqrt{4t})]. \quad (\text{A.5})$$

Using the translation theorem from Laplace transform theory (Churchill, 1972) it follows that another pair is

$$f_1(u, k, s) = (2b - 1) \frac{\exp(-k\sqrt{s + u^2})}{u^2 + bs - u\sqrt{s + u^2}} = \frac{\exp(-k\sqrt{s + u^2})/u}{\sqrt{s + u^2} - u} - \frac{\exp(-k\sqrt{s + u^2})/u}{\sqrt{s + u^2} + u}, \quad (\text{A.6})$$

$$F_1(u, k, t) = \exp(-ku) [1 + \operatorname{erf}(u\sqrt{t} - k/\sqrt{4t})] + d \exp[-(1 - d^2)u^2 t + dku] [1 - \operatorname{erf}(du\sqrt{t} + k/\sqrt{4t})], \quad (\text{A.7})$$

where b is a parameter, assumed to be larger than 1, $b > 1$, and d is related to b by the relation

$$d = 1 - 1/b, \quad b = 1/(1 - d). \quad (\text{A.8})$$

It follows that $0 < d < 1$.

For $k = 0$ the equations (A.6) and (A.7) reduce to the following pair of Laplace transforms.

$$f_2(u, s) = \frac{2b - 1}{u^2 + bs - u\sqrt{s + u^2}} = \frac{1/u}{\sqrt{s + u^2} - u} - \frac{1/u}{\sqrt{s + u^2} + du}, \quad (\text{A.9})$$

$$F_2(u, t) = 1 + \operatorname{erf}(u\sqrt{t}) + d \exp[-(1 - d^2)u^2t][1 - \operatorname{erf}(du\sqrt{t})]. \quad (\text{A.10})$$

Dimensionless forms

Dimensionless variables may be introduced as $x = ua/\sqrt{c}$, $\zeta = k\sqrt{c}/a$, $\tau = ct/a^2$ and $\sigma = sa^2/c$, where a is a characteristic length. Taking into account that the Laplace transform time parameter now includes a factor c/a^2 , the first pair of functions is

$$f_1(x, \zeta, \sigma) = (2b - 1) \frac{\exp(-\zeta\sqrt{x^2 + \sigma})}{x^2 + b\sigma - x\sqrt{x^2 + \sigma/c}}, \quad (\text{A.11})$$

$$F_1(x, \zeta, \tau) = \exp(-\zeta x)[1 + \operatorname{erf}(x\sqrt{\tau} - \zeta/\sqrt{4\tau})] \\ + d \exp[-(1 - d^2)x^2\tau + d\zeta x][1 - \operatorname{erf}(dx\sqrt{\tau} + \zeta/\sqrt{4\tau})]. \quad (\text{A.12})$$

And the second pair of functions, for $\zeta = 0$, is

$$f_2(x, \sigma) = (2b - 1) \frac{1}{x^2 + b\sigma - x\sqrt{x^2 + \sigma}}, \quad (\text{A.13})$$

$$F_2(x, \tau) = 1 + \operatorname{erf}(x\sqrt{\tau}) + d \exp[-(1 - d^2)x^2\tau][1 - \operatorname{erf}(dx\sqrt{\tau})]. \quad (\text{A.14})$$

Written in this form the equations are more suitable for numerical analysis.

REFERENCES

- J. Abate and W. Whitt, Unified framework for numerically inverting Laplace transforms, *INFORMS J. Comput.*, **18**, 408-421, 2006.
- M.B. Abbott, One-dimensional consolidation of multi-layered soils, *Géotechnique*, **10**, 151-165, 1960.
- Y. Abousleiman, A.H.-D. Cheng, L. Cui, E. Detournay and J.C. Roegiers, Mandel's problem revisited, *Géotechnique*, **46**, 187-195, 1996.
- M. Abramowitz and I.A. Stegun, *Handbook of Mathematical Functions*, National Bureau of Standards, Washington, 1964.
- F.B.J. Barends, Landsubsidence due to a well in elastic saturated subsoil, *Proc. Euromech 143*, (A. Verruijt and F.B.J. Barends, eds.), Balkema, Rotterdam, 11-18, 1981.
- R. Barrett, M. Berry, T.F. Chan, J. Demmel, J. Donato, J. Dongarra, V. Eijkhout, R. Pozo, C. Romine and H.A. van der Vorst, *Templates for the Solution of Linear Systems: Building Blocks for Iterative Methods*, SIAM, Philadelphia, 1994.
- H. Bateman, *Tables of Integral Transforms*, 2 vols, McGraw-Hill, New York, 1954.
- K.J. Bathe, *Finite Element Procedures in Engineering Analysis*, Prentice-Hall, Englewood Cliffs, 1982.
- J. Bear, *Hydraulics of Groundwater*, McGraw-Hill, New York, 1979.
- J. Bear and M.Y. Corapcioglu, Mathematical model for regional land subsidence due to pumping. 2. Integrated aquifer subsidence equations for vertical and horizontal displacements, *Water Resources Res.*, **17**, 947-958, 1981.
- J.G. Berryman, Confirmation of Biot's theory, *Appl. Phys. Lett.*, **37**, 382-384, 1980.
- J.G. Berryman, Origin of Gassman's equations, *Geophysics*, **64**, 1627-1629, 1999.
- M.A. Biot, General theory of three-dimensional consolidation, *J. Appl. Phys.*, **12**, 155-164, 1941.
- M.A. Biot, Theory of propagation of elastic waves in a fluid-saturated porous solid, *J. Acoust. Soc. Amer.*, **28**, 168-191, 1956.
- M.A. Biot, General solutions of the equations of elasticity and consolidation for a porous material, *J. Appl. Mech.*, **23**, 91-96, 1956.
- M.A. Biot, Theory of propagation of elastic waves in a fluid-saturated porous solid, *J. Acoust. Soc. Amer.*, **28**, 168-191, 1956.
- M.A. Biot and D.G. Willis, The elastic coefficients of the theory of consolidation, *J. Appl. Mech.*, **24**, 594-601, 1957.
- A.W. Bishop and D.J. Henkel, *The Measurement of Soil Properties in the Triaxial Test*, 2nd ed., Edward Arnold, London, 1962.
- A.W. Bishop and G.E. Blight, Some aspects of effective stress in saturated and partly saturated soils, *Géotechnique*, **13**, 177-197, 1963.
- A.W. Bishop, The influence of an undrained change in stress on the pore pressure in porous media of low compressibility, *Géotechnique*, **23**, 435-442, 1973.
- B.A. Boley and J.H. Weiner, *Theory of Thermal Stresses*, Wiley, New York, 1960.
- J.R. Booker, A numerical method for the solution of Biot's consolidation theory, *Quart. J. Mech. Appl. Math.*, **26**, 457-470, 1973.
- J.R. Booker and J.C. Small, An investigation of the stability of the numerical solution of Biot's equations of consolidation, *Int. J. Solids Struct.*, **11**, 907-917, 1974.
- J.R. Booker and J.P. Carter, Analysis of a point sink in a porous elastic half space, *Int. J. Num. Anal. Meth. Geomech.*, **10**, 137-150, 1986.
- J.R. Booker and J.P. Carter, Elastic consolidation around a point sink embedded in a half-space with anisotropic permeability, *Int. J. Num. Anal. Meth. Geomech.*, **11**, 61-77, 1987.
- J.R. Booker and J.P. Carter, Withdrawal of a compressible pore fluid from a point sink in an isotropic elastic half space with anisotropic permeability, *Int. J. Solids Struct.*, **23**, 369-385, 1987.
- R.M. Bowen, Incompressible porous media models by use of the theory of mixtures, *Int. J. Eng. Sci.*, **18**, 1129-1148, 1980.

- R.M. Bowen, Compressible porous media models by use of the theory of mixtures, *Int. J. Eng. Sci.*, **20**, 697-735, 1982.
- J.E. Bowles, *Analytical and Computer Methods in Foundation Engineering*, McGraw-Hill, New York, 1974.
- R.B.J. Brinkgreve and P.A. Vermeer, *PLAXIS, Finite Element Code for Soil and Rock Analysis*, Swets and Zeitlinger, Lisse, 2002.
- H.S. Carslaw and J.C. Jaeger, *Operational Methods in Applied Mathematics*, 2nd ed., Oxford University Press, London, 1948.
- H.S. Carslaw and J.C. Jaeger, *Conduction of Heat in Solids*, 2nd ed., Clarendon Press, Oxford, 1959.
- K.T. Chau, Fluid point source and point forces in linear elastic diffusive half-spaces, *Mech. of Materials*, **23**, 241-253, 1996.
- A.H.-D. Cheng and E. Detournay, A direct boundary element method for plane strain poroelasticity, *Int. J. Num. and Analyt. Methods in Geomech.*, **12**, 551-572, 1988.
- R.V. Churchill, *Operational Mathematics*, 3d ed., McGraw-Hill, New York, 1972.
- J.J. Christian and J.W. Boehmer, Plane strain consolidation by finite elements, *J. Soil Mech. and Found. Div., Proc. ASCE*, **96**, 1435-1457, 1970.
- J.J. Christian, J.W. Boehmer and P.P. Martin, Consolidation of a layer under a strip load, *J. Soil Mech. and Found. Div., Proc. ASCE*, **98**, 693-707, 1972.
- O. Coussy, *Mechanics of Porous Continua*, Wiley, New York, 1995.
- O. Coussy, *Poromechanics*, Wiley, Chichester, 2004.
- R.F. Craig, *Soil Mechanics*, 6th ed., Spon, London, 1997.
- C.W. Cryer, A comparison of the three-dimensional consolidation theories of Biot and Terzaghi, *Quart. J. Mech. and Appl. Math.*, **16**, 401-412, 1963.
- L.P. Dake, *Fundamentals of Reservoir Engineering*, Elsevier, Amsterdam, 1978.
- R.O. Davis and A.P.S. Selvadurai, *Elasticity and Geomechanics*, Cambridge University Press, Cambridge, 1996.
- R. De Boer, *Theory of Porous Media*, Springer, Berlin, 2000.
- R. De Boer, R.L. Schiffman and R.E. Gibson, The origins of the theory of consolidation: the Terzaghi-Fillunger dispute, *Géotechnique*, **46**, 175-186, 1996.
- G. De Josselin de Jong, Consolidation around pore-pressure meters, *J. Appl. Phys.*, **24**, 922-928, 1953.
- G. De Josselin de Jong, Application of stress functions to consolidation problems, *Proc. 4th Int. Conf. Soil Mech. and Found. Eng., London*, **1**, 320-323, 1957.
- G. De Josselin de Jong, Wat gebeurt er in de grond tijdens het heien?, *De Ingenieur*, **68**, B77-B88, 1956.
- G. De Josselin de Jong, Consolidatie in drie dimensies, *LGM-Mededelingen*, **7**, 25-73, 1963.
- E.H. De Leeuw, The theory of three-dimensional consolidation applied to cylindrical bodies, *Proc. 6th Int. Conf. Soil Mech. and Found. Engng*, **1**, 287-290, 1965.
- R.J.M. De Wiest, *Geohydrology*, Wiley, New York, 1965.
- E. Detournay and A.H.-D. Cheng, Fundamentals of poroelasticity, *Comprehensive Rock Engineering: Principles, Practice and Projects, Vol. II, Analysis and Design Method*, C. Fairhurst (editor), Pergamon Press, 113-171, 1993.
- D.G. Duffy, *Transform Methods for Solving Partial Differential Equations*, CRC Press, Boca Raton, 1994.
- E.J. Dijksterhuis, *The Principal Works of Simon Stevin*, Swets and Zeitlinger, Amsterdam, 1955,
- W. Ehlers and J. Bluhm, *Porous Media: Theory, Experiments and Numerical Applications*, Springer, Berlin, 2002.
- A. Erdélyi, W. Magnus, F. Oberhettinger and F.G. Tricomi, *Tables of Integral Transforms*, 2 vols, McGraw-Hill, New York, 1954.
- J.D. Eshelby, Elastic inclusions and inhomogeneities, *Progress in Solid Mechanics* (I.N. Sneddon and R. Hill, editors), **2**, 88-140, North-Holland, Amsterdam, 1961.
- M.K. Fabian, *Near surface tilt and pore pressure changes induced by pumping in multi-layered poroelastic half-spaces*, Ph.D. Thesis, Bonn, 2004.
- M. Ferronato, N. Castelletto and G. Gambolati, A fully coupled 3-D mixed finite element model of Biot consolidation, *J. Comput. Physics*, **229**, 4813-4830, 2010.
- P. Fillunger, *Erdbaumechanik* ?, Selbstverlag des Verfassers, Wien, 1936.
- L.N.G. Filon, *Phil. Trans. Royal Soc. London*, **A201**, 63-155, 1903.
- V.A. Florin, *Fundamentals of Soil Mechanics*, Gosstroizdat, Leningrad, Moscow, 1961.

- G. Gambolati, Second-order theory of flow in three-dimensional deforming media, *Water Resources Res.*, **10**, 1217-1228, 1974.
- G. Gambolati, P. Teatini and M. Ferronato, Anthropogenic Land Subsidence, *Encyclopedia of Hydrological Sciences*, Wiley, Chichester, UK, DOI 10.1002/0470848944.hsa164b, 2006.
- F. Gassmann, Über die Elastizität poröser Medien, *Vierteljahrsschrift der Naturforschenden Gesellschaft in Zürich*, **96**, 1-23, 1951.
- J. Geertsma, A remark on the analogy between thermoelasticity and the elasticity of saturated porous media, *J. Mech. Phys. Solids*, **6**, 13-16, 1957.
- J. Geertsma, The effect of fluid-pressure decline on volumetric changes of porous rocks, *Trans. AIME*, **210**, 331-343, 1957.
- N.M. Gersevanov, *Dynamika Gruntovoi Mass*, Gosstroizdat, Moscow, 1934.
- R.E. Gibson and P. Lumb, Numerical solutions of some problems in the consolidation of clay, *Proc. Inst. Civ. Engrs*, **2**, 182-198, 1953.
- R.E. Gibson and J. McNamee, A three-dimensional problem of the consolidation of a semi-infinite clay stratum, *Quart. J. Mech. Appl. Math.*, **16**, 115-127, 1963.
- R.E. Gibson, K. Knight and P.W. Taylor, A critical experiment to examine theories of three-dimensional consolidation, *Proc. Eur. Conf. Soil Mech. Wiesbaden*, **1**, 69-76, 1963.
- R.E. Gibson, G.L. England and M.J.L. Hussey, The theory of one-dimensional consolidation of saturated clays, *Géotechnique*, **17**, 261-273, 1967.
- R.E. Gibson, R.L. Schiffman and S.L. Pu, Plane strain and axially symmetric consolidation of a clay layer on a smooth impervious base, *Quart. J. Mech. Appl. Math.*, **23**, 505-520, 1970.
- R.E. Gibson, A. Gobert and R.L. Schiffman, On Cryer's problem with large displacements, *Int. J. Num. Anal. Meth. Geomech.*, **13**, 251-262, 1989.
- R.E. Gibson, A. Gobert and R.L. Schiffman, On Cryer's problem with large displacements and variable permeability, *Géotechnique*, **40**, 627-631, 1990.
- A.E. Green and W. Zerna, *Theoretical Elasticity*, Clarendon Press, Oxford, 1954.
- W. Gröbner and N. Hofreiter, *Integraltafel*, Springer, Wien, 1961.
- M.S. Hantush and C.E. Jacob, Non-steady radial flow in an infinite leaky aquifer, *Trans. Amer. Geophys. Union*, **36**, 95-100, 1955.
- M.S. Hantush, Analysis of data from pumping tests in leaky aquifers, *Trans. Amer. Geophys. Union*, **37**, 702-714, 1956.
- M.E. Harr, *Foundations of Theoretical Soil Mechanics*, McGraw-Hill, New York, 1966.
- D.C. Helm, Horizontal aquifer movements in a Theis-Thiem confined system, *Water Resources Res.*, **30**, 953-964, 1994.
- P.A. Hsieh and R.L. Cooley, Comment on "Horizontal aquifer movements in a Theis-Thiem confined system" by Donald C. Helm, *Water Resources Res.*, **31**, 3107-3111, 1995.
- C.E. Jacob, On the flow of water in an elastic artesian aquifer, *Trans. Amer. Geophys. Union*, **21**, 574-586, 1940.
- O.D. Kellogg, *Foundations of Potential Theory*, Ungar, New York, 1929.
- J.-M. Kim and R.R. Parizek, Numerical simulation of the Noordbergum effect resulting from groundwater pumping in a layered aquifer system, *J. Hydrology*, **202**, 231-243, 1997.
- H.L. Koning, Wave propagation in a porous seabed, *Report Delft Soil Mech. Lab.*, 0-14683-II, 1968.
- D.E. Knuth, *The TeXbook*, Addison Wesley, Reading, 1986.
- H. Lamb, *Hydrodynamics*, 6th ed., University Press, Cambridge, 1932.
- T.W. Lambe and R.V. Whitman, *Soil Mechanics*, Wiley, New York, 1969.
- L. Lamport, *LaTeX*, 2nd ed., Addison Wesley, Reading, 1994.
- F.-T. Lin and J.C.-C. Lu, Transient ground surface displacements of a poroelastic half space subjected to an impulsive line sink, *Proc. 2nd Int. ISCM Symposium*, Amer. Inst. Phys., 401-406, 2010.
- A.E.H. Love, *A Treatise on the Mathematical Theory of Elasticity*, 4th ed., Dover, New York, 1944.
- O.S. Madsen, Wave-induced pore pressures and effective stresses in a porous bed, *Géotechnique*, **28**, 377-393, 1978.
- J. Mandel, Consolidation des Sols, *Géotechnique*, **7**, 287-299, 1953.
- D.P. Mason, A. Solomon and L.O. Nicolayson, Evolution of stress and strain during consolidation of a fluid-saturated porous elastic sphere, *J. Appl. Phys.*, **70**, 4724-4740, 1991.

- D.P. Mason, A. Solomon and L.O. Nicolayson, Numerical solution for the dilation of a fluid-saturated porous elastic sphere due to a point source of fluid at the centre of the sphere, *Int. J. Numer. Anal. Meth. Geomech.*, **17**, 699-714, 2005.
- J. McNamee and R.E. Gibson, Displacement functions and linear transforms applied to diffusion through porous media, *Quart. J. Mech. Appl. Math.*, **13**, 98-111, 1960.
- J. McNamee and R.E. Gibson, Plane strain and axially symmetric problems of the consolidation of a semi-infinite clay stratum, *Quart. J. Mech. Appl. Math.*, **13**, 210-227, 1960.
- L.W. Morland, R. Foulser and S.K. Garg, Mixture theory for a fluid-saturated isotropic elastic matrix, *Int. J. Geomech.*, **4**, 207-215, 2004.
- P.M. Morse and H. Feshbach, *Methods of Theoretical Physics*, McGraw-Hill, New York, 1953, (reprinted by Feshbach Publishing, Minneapolis, 1981).
- M. Muskat, *The Flow of Homogeneous Fluids through Porous Media*, McGraw-Hill, New York, 1937.
- T.J. Plona, Observation of a second bulk compressional wave in a porous medium at ultrasonic frequencies, *Appl. Phys. Lett.* **36**, 259-261, 1980.
- P.Ya. Polubarinova-Kochina, *Theory of Groundwater Movement*, translated from the Russian by J.R.M. De Wiest, Princeton University Press, Princeton, 1962.
- H.G. Poulos and E.H. Davis, *Elastic Solutions for Soil and Rock Mechanics*, Wiley, New York, 1974.
- W.H. Press, B.P. Flannery, S.A. Teukolsky and W.T. Vetterling, *Numerical Recipes in C*, Cambridge University Press, Cambridge, 1988.
- M.F. Randolph and C.P. Wroth, An analytical solution for the consolidation around a driven pile, *Int. J. Num. Anal. Meth. Geomech.*, **3**, 217-229, 1979.
- L. Rendulic, Porenziffer und Porenwasserdruck in Tonen, *Der Bauingenieur*, **17**, 559-564, 1936.
- J.R. Rice and M.P. Cleary, Some basic stress diffusion solutions for fluid saturated elastic porous media with compressible constituents, *Rev. Geophys. Space Phys.*, **14**, 227-241, 1976.
- J.R. Rice, J.W. Rudnicki and D.A. Simons, Deformation of spherical cavities and inclusions in fluid-infiltrated elastic materials, *Int. J. Solids Struct.*, **14**, 289-303, 1978.
- J.D. Rodrigues, The Noordbergum effect and characterization of aquitards at the Rio Maior mining project, *Groundwater*, **21**, 200-207, 1983.
- J.W. Rudnicki, Linear poroelasticity, *Handbook of Material Behavior Models*, (J. Lemaitre, editor), Academic Press, 1118-1125, 2001.
- M.H. Sadd, *Elasticity: Theory, Applications and Numerics*, Elsevier, Amsterdam, 2005.
- R.S. Sandhu and E.C. Wilson, Finite element analysis of seepage in elastic media, *J. Eng. Mech. Div., Proc. ASCE*, **95**, 641-652, 1969.
- G. Santing, A remarkable geohydrological phenomenon in Noordbergum (in Dutch), *Hydrologisch Colloquium*, **320**, 1955.
- M. Schanz, Poroelastodynamics: Linear models, Analytical Solutions, and Numerical Methods, *Appl. Mech. Reviews*, **62**, 2009.
- R.A. Schapery, Approximate methods of transform inversion for visco-elastic stress analysis, *Proc. 4th U.S. Nat. Congress on Appl. Mech.*, **2**, 1075-1085, 1962.
- R.L. Schiffman, A bibliography of consolidation, *Fundamentals of Transport Phenomena in Porous Media*, (J. Bear and M.Y. Corapcioglu, editors), Martinus Nijhoff, Dordrecht, 617-669, 1984.
- R.L. Schiffman, *Theories of Consolidation*, University of Colorado Press, Boulder, 2000.
- A.N. Schofield and C.P. Wroth, *Critical State Soil Mechanics*, McGraw-Hill, London, 1968.
- R.F. Scott, *Principles of Soil Mechanics*, Addison-Wesley, Reading, 1963.
- F.W. Sears, M.W. Zemansky and H.D. Young, *University Physics*, Addison-Wesley, Reading, 1976.
- A.P.S. Selvadurai, *Elastic Analysis of Soil-Foundation Interaction*, Elsevier, Amsterdam, 1979.
- A.P.S. Selvadurai, *Partial Differential Equations in Mechanics 2*, Springer, Berlin, 2000.
- A.P.S. Selvadurai, *Mechanics of Poroelastic Media*, Kluwer, Dordrecht, 2010.
- G.C. Sills, Some conditions under which Biot's equations of consolidation reduce to Terzaghi's equations, *Géotechnique*, **25**, 129-132, 1975.
- A.W. Skempton, The pore pressure coefficients A and B, *Géotechnique*, **4**, 143-147, 1954.
- A.W. Skempton, Effective stress in soils, concrete and rocks, *Pore Pressure and Suction in Soils*, 4-16, Butterworth, London, 1960.
- D.M.J. Smeulders, *On Wave Propagation in Saturated and Partially Saturated Porous Media*, Ph.D. Thesis, Eindhoven, 1992.

- I.M. Smith and R. Hobbs, Biot analysis of consolidation beneath embankments, *Géotechnique*, **26**, 149-171, 1976.
- I.M. Smith, Some time-dependent soil-structure interaction problems, *Finite Elements in Geomechanics*, (G. Gudehus, editor), Wiley, London, 1977.
- I.M. Smith, *Programming the Finite Element Method*, Wiley, London, 1982.
- I.N. Sneddon, *Fourier Transforms*, McGraw-Hill, New York, 1951.
- I.N. Sneddon, *Mixed Boundary Value Problems in Potential Theory*, North-Holland, Amsterdam, 1966.
- L.O. Soderberg, Consolidation theory applied to foundation pile time effects, *Géotechnique*, **12**, 217-225, 1962.
- I.S. Sokolnikoff, *Mathematical Theory of Elasticity*, 2nd ed., McGraw-Hill, New York, 1956.
- S.E.J. Spierenburg, Wave-induced pore pressures around submarine pipelines, *Coastal Engng.*, **10**, 33-48, 1986.
- S.E.J. Spierenburg, *Seabed Response to Water Waves*, Ph.D. Thesis, Delft, 1987.
- H. Stehfest, Algorithm 368, *Commun. Assoc. Comput. Math.*, **13**, 47-49, 1970.
- S. Stevin, *De Beghinselen des Waterwichts*, Pantijn, Leyden, 1586.
- Y.M. Sternberg, Some approximate solutions of radial flow problems, *J. Hydrology*, **7**, 158-166, 1969.
- O.D.L. Strack, *Groundwater Mechanics*, Prentice-Hall, Englewood Cliffs, 1989.
- A. Talbot, The accurate inversion of Laplace transforms, *J. Inst. Math. Appl.*, **23**, 97-120, 1979.
- K. Terzaghi, Die Berechnung der Durchlässigkeitsziffer des Tones aus dem Verlauf der hydrodynamische Spannungserscheinungen, *Sitzber. Akad. Wiss. Wien, Abt. IIa*, **132**, 125-138, 1923.
- K. Terzaghi, *Erdbaumechanik auf bodenphysikalischer Grundlage*, Deuticke, Wien, 1925.
- K. Terzaghi and O.K. Fröhlich, *Theorie der Setzung von Tonschichten*, Deuticke, Leipzig, 1936.
- K. Terzaghi, *Theoretical Soil Mechanics*, Wiley, New York, 1943.
- C.V. Theis, The relation between the lowering of the piezometric surface and rate and duration of a well using groundwater storage, *Trans. Amer. Geophys. Union*, **2**, 519-524, 1935.
- S.P. Timoshenko and J.N. Goodier, *Theory of Elasticity*, 3d ed., McGraw-Hill, New York, 1970.
- E.C. Titchmarsh, *Theory of Fourier Integrals*, 2nd ed., Clarendon Press, Oxford, 1948.
- N.A. Tsytoich and Yu.K. Zaretsky, The development of the theory of soil consolidation in the U.S.S.R., 1917-1967, *Géotechnique*, **19**, 357-375, 1969.
- H.A. Van der Vorst, BI-CGSTAB: A fast and smoothly converging variant of BI-CG for the solution of nonsymmetric linear systems, *SIAM J. Sci. Stat. Comput.* **13**, 631-644, 1992.
- P.A. Vermeer and A. Verruijt, An accuracy condition for consolidation by finite elements, *Int. J. Num. Anal. Meth. Geomech.*, **5**, 1-14, 1981.
- A. Verruijt, Discussion on consolidation of a massive sphere, *Proc. 6th Int. Conf. Soil Mech. Montreal*, **3**, 401-402, 1965.
- A. Verruijt, Elastic storage of aquifers, *Flow through Porous Media*, (R.J.M. De Wiest, editor), Academic Press, New York, 1969.
- A. Verruijt, Horizontal displacements in pumped aquifers, *EOS (Trans. AGU)*, **51**, 284, 1970.
- A. Verruijt, Displacement functions in the theory of consolidation or in thermoelasticity, *J. Appl. Math. Phys. (ZAMP)*, **22**, 891-898, 1971.
- A. Verruijt, Solution of transient groundwater flow problems by the finite element method, *Water Resources Res.*, **8**, 725-727, 1972.
- A. Verruijt, Generation and dissipation of pore-water pressures, *Finite Elements in Geomechanics*, (G. Gudehus, editor), Wiley, London, 1977.
- A. Verruijt, A simple formula for the estimation of pore pressures and their dissipation, *Appl. Ocean Res.*, **2**, 57-62, 1980.
- A. Verruijt, *Theory of Groundwater Flow*, 2nd ed., Macmillan, London, 1982.
- A. Verruijt, *Computational Geomechanics*, Kluwer Academic Publishers, Dordrecht, 1995.
- A. Verruijt, Consolidation of soils, *Encyclopedia of Hydrological Sciences*, Wiley, Chichester, UK. DOI 10.1002/0470848944.hsa303, 2008.
- A. Verruijt, *An Introduction to Soil Dynamics*, Springer, Dordrecht, 2010.
- L.J. Walpole, The Green functions of an elastic medium surrounding a rigid spherical inclusion, *Quart. J. Mech. Appl. Math.*, **58**, 129-141, 2005.
- H.F. Wang, *Theory of Linear Poroelasticity*, Princeton University Press, Princeton, 2000.

- G.N. Watson, *Theory of Bessel Functions*, 2nd ed., Cambridge University Press, 1944.
- E.W. Weisstein, *The CRC Concise Encyclopedia of Mathematics*, CRC Press, Boca Raton, 1999.
- M.J. Wichura, *The PiCTeX Manual*, TeX Users Group, Providence, 1987.
- R.G. Wolff, Relationship between horizontal strain near a well and reverse water level fluctuation, *Water Resources Res.*, **6**, 1721-1728, 1970.
- T.T. Wong, D.G. Fredlund and J. Krahn, A numerical study of coupled consolidation in unsaturated soils, *Can. Geotech. J.*, **35**, 926-937, 1998.
- D.M. Wood, *Soil Behaviour and Critical State Soil Mechanics*, Cambridge University Press, Cambridge, 1990.
- C.R. Wylie, *Advanced Engineering Mathematics*, 2nd ed., McGraw-Hill, New York, 1960.
- T. Yamamoto, H.L. Koning, J.B. Sellmeijer and E. Van Hijum, On the response of a poro-elastic bed to water waves, *J. Fluid Mech.*, **87**, 193-206, 1978.
- Yu.K. Zaretsky, *Teoriya Konsolidatsii Gruntov*, Publishing House Science, Moscow, 1967.
- O.C. Zienkiewicz, *The finite element method*, 3d ed., McGraw-Hill, London, 1977.
- O.C. Zienkiewicz, C.T. Chang and P. Bettess, Drained, undrained, consolidating and dynamic behaviour assumptions in soils, *Géotechnique*, **30**, 385-395, 1980.
- D. Znidarcic and R.L. Schiffman, On Terzaghi's concept of consolidation, *Géotechnique*, **32**, 387-389, 1982.
- C. Zwanenburg, *The Influence of Anisotropy on the Consolidation Behaviour of Peat*, Ph.D. Thesis, Delft, 2005.

Author Index

- Abate, J., 53, 115, 153, 198, 254, 256
Abbott, M.B., 19, 44, 256
Abousleiman, Y., 256
Abramowitz, M., 69, 72, 77, 79, 89, 111, 113, 128,
129, 131, 138, 139, 189, 256
- Barends, F.B.J., 87, 256
Barrett, R., 256
Bateman, H., 78, 256
Bathe, K.J., 44, 208, 256
Bear, J., 109, 113, 114, 117, 118, 129, 132, 256
Berry, M., 256
Berryman, J.G., 3, 256
Bettess, P., 29, 261
Biot, M.A., 1, 3, 11, 14, 26, 28, 49, 109, 110, 117,
252, 256
Bishop, A.W., 1, 3, 256
Blight A.W., 256
Bluhm, J., 257
Boehmer, J.W., 160, 182, 208, 257
Boley, B.A., 256
Booker, J.R., 40, 45, 78, 87, 208, 212, 224, 233,
246, 256
Bowen, R.M., 25, 26, 256, 257
Bowles, J.E., 257
Brinkgreve, R.B.J., 257
- Carslaw, H.S., 19, 29, 33, 37, 38, 49, 52, 56, 62, 65,
71, 78, 80, 114, 125, 254, 257
Carter, J.P., 78, 87, 256
Castelletto, N., 225, 257
Chan, T.F., 256
Chang, C.T., 29, 261
Chau, K.T., 87, 257
Cheng, A.H.-D., 1, 6, 12, 49, 66, 140, 143, 256, 257
Christian, J.T., 160, 182, 208, 257
Churchill, R.V., 18, 19, 33, 34, 38, 39, 52, 71, 77,
79, 89, 90, 128, 158, 169, 171, 174, 176,
189, 190, 200, 254, 257
Cleary, M.P., 11, 259
Cooley, R.L., 109, 117, 258
Corapcioglu, M.Y., 109, 117, 118, 129, 132, 256
Coussy, O., 1, 3, 25, 257
Craig, R.F., 1, 27, 257
Cryer, C.W., 49, 54, 58, 257
Cui, L., 256
- Dake, L.P., 14, 257
- Davis, E.H., 259
Davis, R.O., 257
De Boer, R., 1, 16, 25, 26, 29, 257
De Josselin de Jong, G., 14, 81, 85, 190, 257
De Leeuw, E.H., 49, 66, 70, 72, 257
De Wiest, R.J.M., 109, 114, 138, 257
Demmel, J., 256
Detournay, E., 1, 6, 12, 49, 66, 140, 143, 256, 257
Dijksterhuis, E.J., 27, 257
Donato, J., 256
Dongarra, J., 256
Duffy, D.G., 257
- Ehlers, W., 257
Eijkhout, V., 256
England, G.L., 28, 258
Erdélyi, A., 80, 254, 257
Eshelby, J.D., 257
- Fabian, M.K., 257
Ferronato, M., 225, 253, 257, 258
Feshbach, H., 113, 259
Fillunger, P., 25, 257
Filon, L.N.G., 169, 172, 174, 176, 257
Flannery, B.P., 259
Florin, V.A., 1, 257
Foulser, R., 259
Fox, L., 21
Fröhlich, O.K., 27, 260
Fredlund, D.G., 261
- Gambolati, G., 1, 109, 225, 252, 257, 258
Garg, S.K., 259
Gassmann, F., 1, 3, 258
Geertsma, J., 1, 3, 258
Gersevanov, N.M., 1, 5, 258
Gibson, R.E., 12, 16, 19, 28, 49, 58, 63, 140, 143,
160, 181, 183, 184, 257-259
Gobert, A., 58, 258
Goodier, J.N., 11, 83, 189, 260
Gröbner, W., 258
Green, A.E., 258
- Hantush, M.S., 128, 138, 258
Harr, M.E., 27, 258
Helm, D.C., 109, 117, 258
Henkel, D.J., 3, 256
Hobbs, R., 208, 260

- Hofreiter, N., 258
Hsieh, P.A., 109, 117, 258
Hussey, M.J.L., 28, 258
- Jacob, C.E., 14, 109, 110, 113, 128, 253, 258
Jaeger, J.C., 19, 29, 33, 37, 38, 49, 52, 56, 62, 65,
71, 78, 80, 114, 125, 254, 257
- Kellogg, O.D., 113, 258
Kim, J.-M., 253, 258
Knight, K., 49, 63, 258
Knuth, D.E., ii, 258
Koning, H.L., 101, 258, 261
Krahn, J., 261
- Lamb, H., 258
Lambe, T.W., 1, 27, 258
Lampert, L., ii, 258
Lin, F.-T., 87, 258
Love, A.E.H., 81, 82, 258
Lu, J.C.-C., 87, 258
Lumb, P., 12, 19, 258
- Madsen, O.S., 101, 108, 258
Magnus, W., 80, 257
Mandel, J., 49, 53, 54, 258
Martin, J.J., 182
Martin, P.P., 160, 257
Mason, D.P., 258, 259
McNamee, J., 140, 143, 183, 184, 258, 259
Morland, L.W., 25, 259
Morse, P.M., 113, 259
Muskat, M., 109, 114, 259
- Nicolayson, L.O., 258, 259
- Oberhettinger, F., 80, 257
- Parizek, R.R., 253, 258
Plona, T.J., 259
Polubarinova-Kochina, P.Ya., 7, 109, 111, 114, 259
Poulos, H.G., 259
Pozo, R., 256
Press, W.H., 259
Pu, S.L., 160, 181, 258
- Randolph, M.F., 259
Rendulic, L., 12, 225, 259
Rice, J.R., 11, 81, 259
Rodrigues, J.D., 253, 259
Roegiers, J.C., 256
Romine, C., 256
Rudnicki, J.W., 1, 81, 259
- Sadd, M.H., 7, 83, 259
Sandhu, R.S., 208, 259
Santing, G., 252, 253, 259
Schanz, M., 259
- Schapery, R.A., 87, 113, 115, 259
Schiffman, R.L., 9, 16, 58, 160, 181, 257–259, 261
Schofield, A.N., 8, 259
Scott, R.F., 27, 259
Sears, F.W., 27, 259
Sellmeijer, J.B., 101, 261
Selvadurai, A.P.S., 83, 257, 259
Sills, G.C., 14, 259
Simons, D.A., 81, 259
Skempton, A.W., 1, 3, 28, 259
Small, J.C., 40, 45, 212, 224, 233, 246, 256
Smeulders, D.M.J., 259
Smith, I.M., 208, 260
Sneddon, I.N., 98, 169, 172, 174, 176, 181, 260
Soderberg, L.O., 260
Sokolnikoff, I.S., 7, 260
Solomon, A., 258, 259
Spierenburg, S.E.J., 101, 260
Stegun, I.A., 69, 72, 77, 79, 89, 111, 113, 128, 129,
131, 138, 139, 189, 256
Stehfest, H., 260
Sternberg, Y.M., 113, 260
Stevin, S., 27, 260
Strack, O.D.L., 109, 113, 114, 260
- Talbot, A., 53, 63, 87, 115, 152, 160, 198, 254, 260
Taylor, P.W., 49, 63, 258
Teatini, P., 258
Terzaghi, K., 1, 3, 4, 9, 14, 16, 27, 49, 260
Teukolsky, S.A., 259
Theis C.V., 253
Theis, C.V., 109, 110, 113, 260
Timoshenko, S.P., 11, 83, 189, 260
Titchmarsh, E.C., 260
Tricomi, F.G., 80, 257
Tsytovich, N.A., 1, 260
- Van der Vorst, H.A., 218, 224, 240, 246, 256, 260
Van Hijum, E., 101, 261
Vermeer, P.A., 224, 247, 257, 260
Verruijt, A., 1, 27, 29, 37, 40, 49, 63, 87, 101, 109,
111, 113, 114, 117, 118, 128, 140, 143, 208,
224, 247, 252, 260
Vetterling, W.T., 259
- Walpole, L.J., 260
Wang, H.F., 1, 6, 9, 11, 12, 260
Watson, G.N., 261
Weiner, J.H., 256
Weisstein, E.W., 261
Whitman, R.V., 1, 27, 258
Whitt, W., 53, 115, 153, 198, 254, 256
Wichura, M.J., ii, 261
Willis, D.G., 1, 3, 11, 256
Wilson, E.C., 208, 259
Wolff, R.G., 109, 117, 252, 261
Wong, T.T., 261

Wood, D.M., 8, 261

Wroth, C.P., 8, 259

Wylie, C.R., 261

Yamamoto, Y., 101, 108, 261

Young, H.D., 27, 259

Zaretsky, Yu.K., 1, 260, 261

Zemansky, M.W., 27, 259

Zerna, W., 258

Zienkiewicz, O.C., 29, 44, 208, 261

Znidarcic, D., 261

Zwanenburg, C., 49, 53, 261

Subject Index

- approximate solution, 96
- approximation of waves, 108
- aquitard, 127
- ASP, 194, 196, 199, 200, 203, 205
- axial symmetry, 183, 230
- axially symmetric poroelasticity, 230

- backward interpolation, 45, 212, 234
- Bessel functions, 138
- Biot's coefficient, 3, 7, 28, 208, 209, 230, 231
- Biot's theory, 1
- Booker and Carter's problem, 87
- boundary conditions, 9
- bulk modulus, 8

- circular load, 230
- compatibility, 8
- compressibility fluid, 2, 4, 209, 231
- compressibility porous medium, 2, 209, 230
- compressibility solids, 2, 5, 209, 230
- compression modulus, 7, 17, 141, 231
- confined compressibility, 9, 17
- confined compression test, 9, 16
- conservation of mass, 4
- consolidation, 1
- consolidation coefficient, 9, 142
- constant isotropic total stress, 12
- contractancy, 8
- CRYER, 63
- Cryer's problem, 58

- Darcy's law, 6, 208, 230
- De Josselin de Jong's problem, 81
- De Leeuw's problem, 66, 250
- degree of consolidation, 22
- DELEEUW, 72
- dilatancy, 8
- disk load, 186, 188
- displacement functions, 142, 185
- divergence theorem, 214, 216, 236, 238
- drained deformations, 9

- effective stress, 3, 4, 7
- elementary problems, 49
- elliptic integral, 189
- equilibrium equations, 7, 141, 184, 209
- equilibrium of moments, 7

- explicit procedure, 20

- Filon's problem, 98, 169
- finite aquifer, 251, 252
- finite confined aquifer, 113, 120
- finite differences, 19, 44, 115
- finite elements, 44, 47, 208, 213, 230, 234
- finite leaky aquifer, 134
- fluid content, 6
- fluid density, 4
- force on spherical inclusion, 81, 87
- forward interpolation, 45
- functional, 45

- Galerkin method, 208, 213, 230, 234
- gradual drainage, 22

- half space, 230
- Hantush's well function, 138
- heat conduction analogy, 29
- Heaviside's theorem, 34, 39, 52, 63, 71
- highly compressible fluid, 14
- Hooke's law, 7, 141, 184, 209, 231
- horizontal displacements, 117
- horizontal effective stress, 159
- horizontal total stress, 157, 158
- horizontally confined deformations, 13
- hydraulic conductivity, 6, 16

- image, 87, 112
- implicit procedure, 20
- infinite confined aquifer, 109, 117
- infinite leaky aquifer, 127
- initial conditions, 9
- initial pore pressure, 152, 166, 197, 198
- intergranular stress, 4
- irrotational deformations, 14
- isoparametric elements, 219, 241
- isotropic effective stress, 150, 151, 196
- isotropic total stress, 148, 149, 194

- Kelvin's solution, 83

- Lamé constants, 8, 141, 210, 232
- Laplace transforms, 254
- lateral confinement preconditioner, 225, 248
- leakage factor, 127
- leaky aquifer, 127, 133

- long waves, 108
 MANDEL, 57
 Mandel's problem, 49
 Mandel-Cryer effect, 13, 49, 54, 57, 63, 72, 250, 252
 mathematics, 138
 method of images, 112, 113
 mixture theory, 25

 Noordbergum effect, 252, 253
 numerical inversion, 152, 198

 oedometer test, 9, 16
 one-dimensional finite elements, 44
 one-dimensional problems, 16

 periodic load, 29
 permeability, 6, 208, 230
 permeability coefficient, 16
 permeability contrast, 42
 plane strain, 140, 208
 plane strain deformations, 140, 160
 plane strain layer, 160
 plane strain poroelasticity, 208
 plane stress model, 117, 120
 pore pressure, 146, 147, 153, 192, 199
 poroelasticity, 1
 poroelastodynamics, 29
 POROFAX, 246, 249, 253
 POROFEM, 224, 227
 porosity, 2, 4, 209, 231
 porous medium, 1
 preconditioner, 13, 224, 225, 246–248
 PSP, 147, 149, 153, 156, 158
 PSPL, 166, 168, 171, 173, 175

 radial total stress, 202, 203
 references, 256
 Rendulic preconditioner, 225, 247
 Rendulic's assumption, 12, 96
 rigid spherical inclusion, 75, 85

 Schapery's inversion method, 109, 115
 seabed response, 101
 semi-confined aquifer, 127
 shape functions, 213, 234
 shear modulus, 7, 17, 141, 231
 sign convention, 7
 SINK, 94
 sink in half space, 87
 sink in infinite poroelastic medium, 77, 79
 Skempton's coefficient, 3, 11
 solids density, 4, 5
 specific discharge, 5
 spherical inclusion, 81
 spherical source, 74
 stability, 21
 standing wave, 101

 stationary wave, 101
 steady flow, 114, 133
 steady state, 30, 31
 storage equation, 5, 101, 109, 118, 122, 140, 183, 208, 230
 storativity, 5, 16, 140, 183, 209, 231
 strip load, 143, 145, 161
 superposition, 87, 91, 112

 Talbot's inversion method, 53, 63, 94, 109, 115, 129, 254
 tangential total stress, 204, 205
 Terzaghi's principle, 7
 Terzaghi's problem, 16, 227, 249
 Theis-Jacob model, 109
 thermoelasticity, 1
 time step, 211, 224, 233, 247
 traveling wave, 101, 107
 two-layered soil, 37

 uncoupled consolidation, 12
 undrained compression modulus, 10, 223, 246
 undrained deformations, 2, 10, 11
 undrained response, 222, 245

 variational principle, 45, 47
 vertical displacement, 189, 190
 vertical effective stress, 157, 201
 vertical total stress, 155, 156, 199, 200
 viscosity, 6, 208, 230
 volumetric weight, 6

 water waves, 101
 wells, 109