

REFRIGERATION CYCLES

Objectives

- Introduce the concepts of refrigerators and heat pumps and the measure of their performance.
- Analyze the ideal vapor-compression refrigeration cycle.
- Analyze the actual vapor-compression refrigeration cycle.
- Review the factors involved in selecting the right refrigerant for an application.
- Discuss the operation of refrigeration and heat pump systems.
- Evaluate the performance of innovative vapor-compression refrigeration systems.
- Analyze gas refrigeration systems.
- Introduce the concepts of absorption-refrigeration systems.

REFRIGERATORS AND HEAT PUMPS

The transfer of heat from a low-temperature region to a high-temperature one requires special devices called **refrigerators**.

Refrigerators and heat pumps are essentially the same devices; they differ in their objectives only.

$$\text{COP}_R = \frac{\text{Desired output}}{\text{Required input}} = \frac{\text{Cooling effect}}{\text{Work input}} = \frac{Q_L}{W_{\text{net,in}}}$$

$$\text{COP}_{\text{HP}} = \frac{\text{Desired output}}{\text{Required input}} = \frac{\text{Heating effect}}{\text{Work input}} = \frac{Q_H}{W_{\text{net,in}}}$$

$$\text{COP}_{\text{HP}} = \text{COP}_R + 1 \quad \text{for fixed values of } Q_L \text{ and } Q_H$$

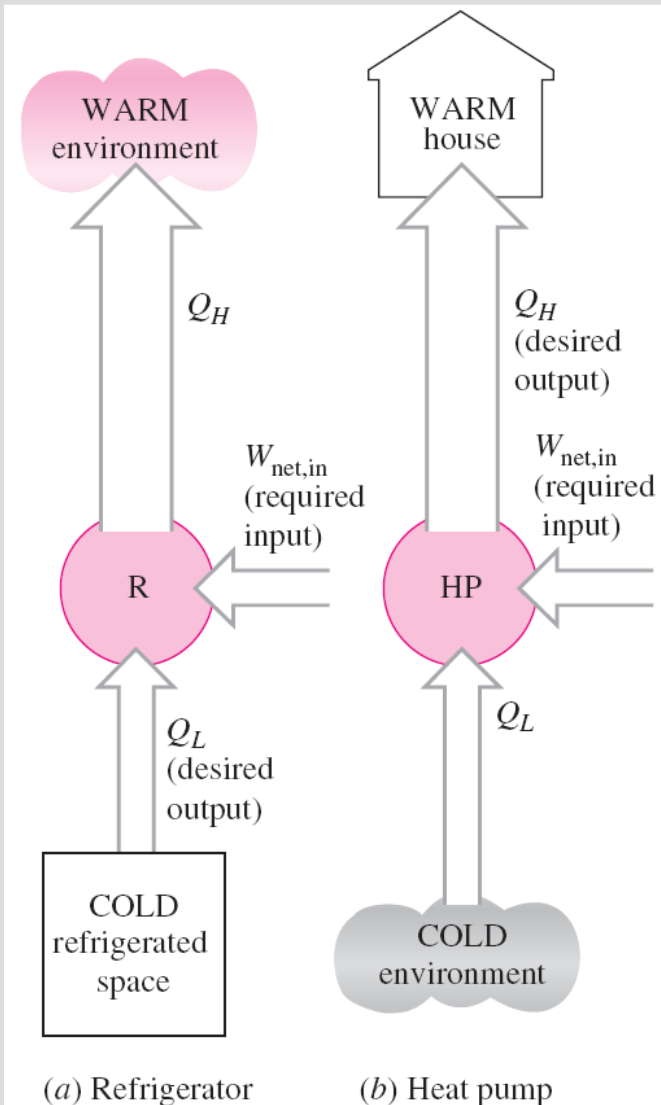

The objective of a refrigerator is to remove heat (Q_L) from the cold medium; the objective of a heat pump is to supply heat (Q_H) to a warm medium.

The reversed Carnot cycle is the *most efficient* refrigeration cycle operating between T_L and T_H .

However, it is not a suitable model for refrigeration cycles since processes 2-3 and 4-1 are not practical because

Process 2-3 involves the compression of a liquid–vapor mixture, which requires a compressor that will handle two phases, and process 4-1 involves the expansion of high-moisture-content refrigerant in a turbine.

THE REVERSED CARNOT CYCLE

$$\text{COP}_{\text{R,Carnot}} = \frac{1}{T_H/T_L - 1}$$

$$\text{COP}_{\text{HP,Carnot}} = \frac{1}{1 - T_L/T_H}$$

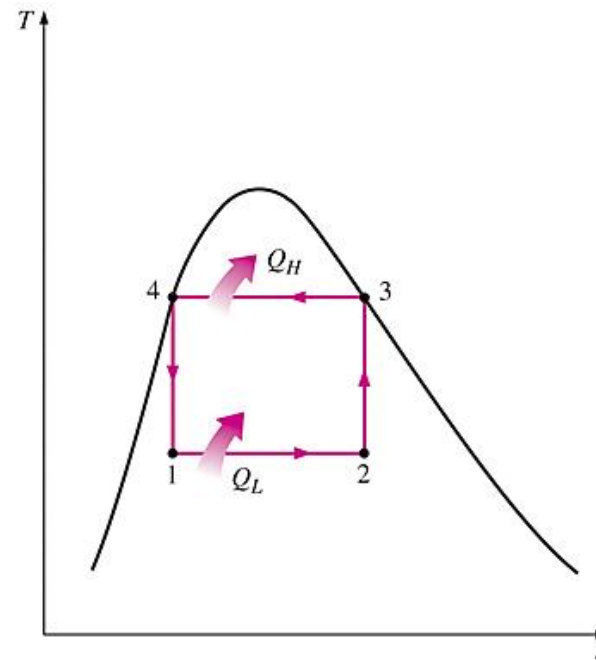
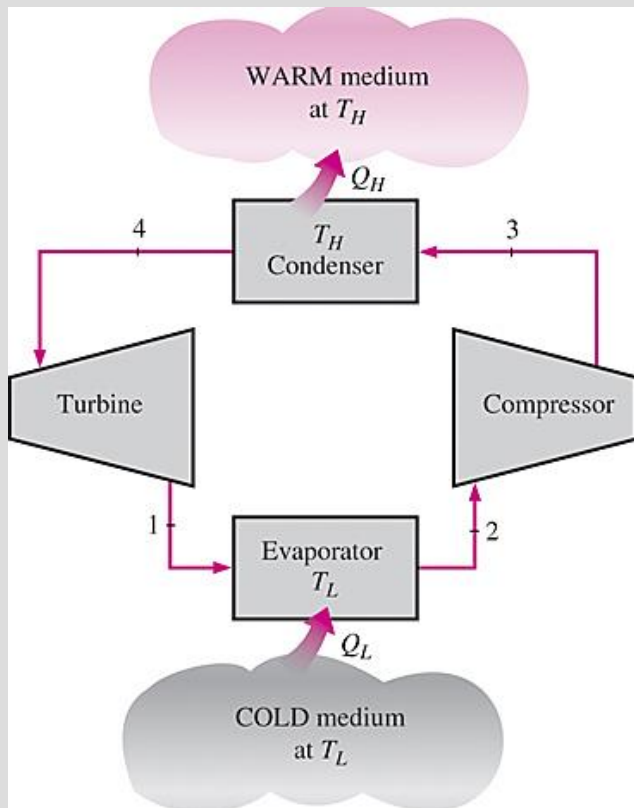

Both COPs increase as the difference between the two temperatures decreases, that is, as T_L rises or T_H falls.

Schematic of a Carnot refrigerator and T - s diagram of the reversed Carnot cycle.

THE IDEAL VAPOR-COMPRESSION REFRIGERATION CYCLE

The **vapor-compression refrigeration cycle** is the ideal model for refrigeration systems. Unlike the reversed Carnot cycle, the refrigerant is vaporized completely before it is compressed and the turbine is replaced with a throttling device.

- | | |
|-----|--|
| 1-2 | Isentropic compression in a compressor |
| 2-3 | Constant-pressure heat rejection in a condenser |
| 3-4 | Throttling in an expansion device |
| 4-1 | Constant-pressure heat absorption in an evaporator |

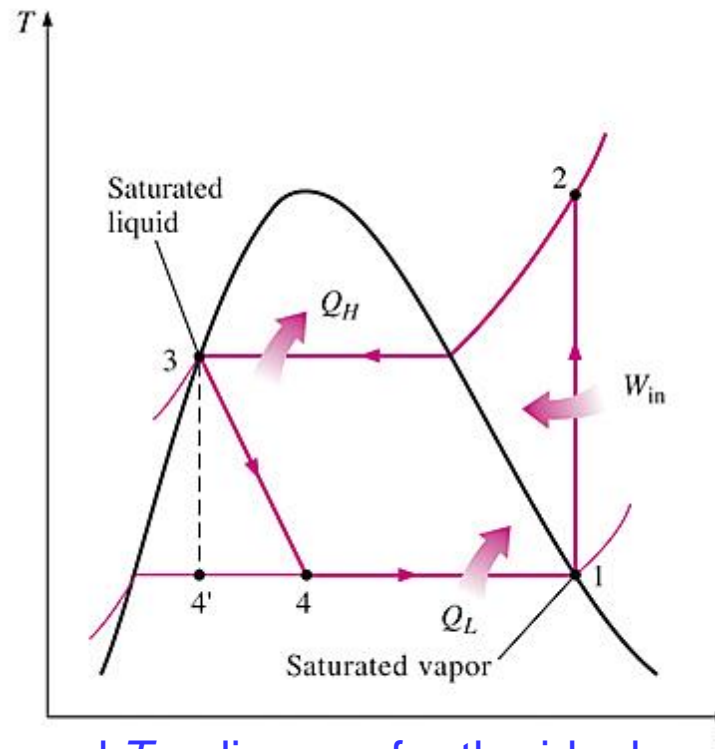
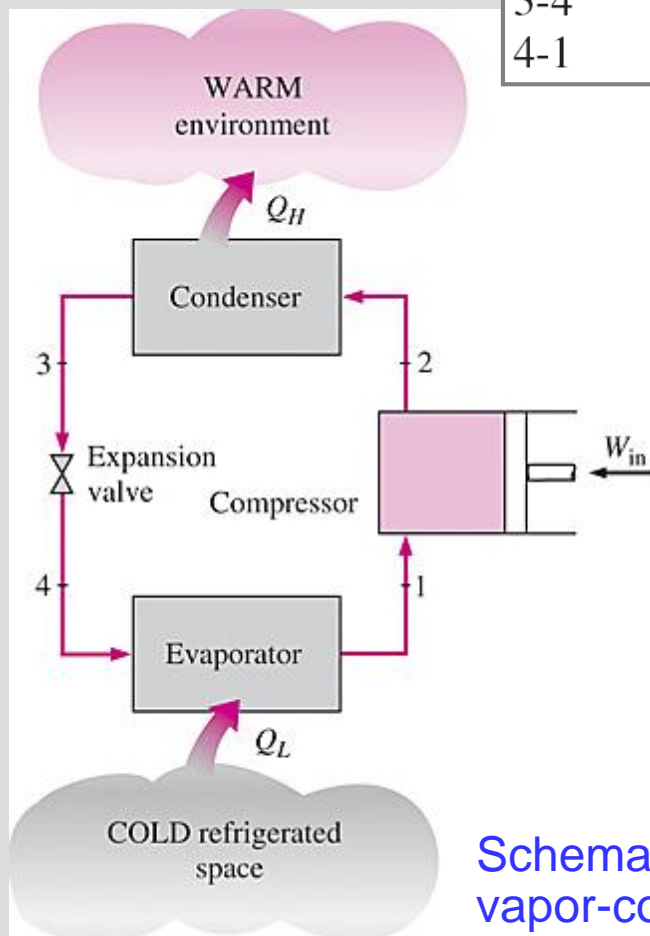

This is the most widely used cycle for refrigerators, A-C systems, and heat pumps.

Schematic and T - s diagram for the ideal vapor-compression refrigeration cycle.

The ideal vapor-compression refrigeration cycle involves an irreversible (throttling) process to make it a more realistic model for the actual systems.

Replacing the expansion valve by a turbine is not practical since the added benefits cannot justify the added cost and complexity.

Steady-flow energy balance $(q_{in} - q_{out}) + (w_{in} - w_{out}) = h_e - h_i$

$$COP_R = \frac{q_L}{w_{net,in}} = \frac{h_1 - h_4}{h_2 - h_1}$$

$$COP_{HP} = \frac{q_H}{w_{net,in}} = \frac{h_2 - h_3}{h_2 - h_1}$$

$h_1 = h_g @ P_1$ and $h_3 = h_f @ P_3$ for the ideal case

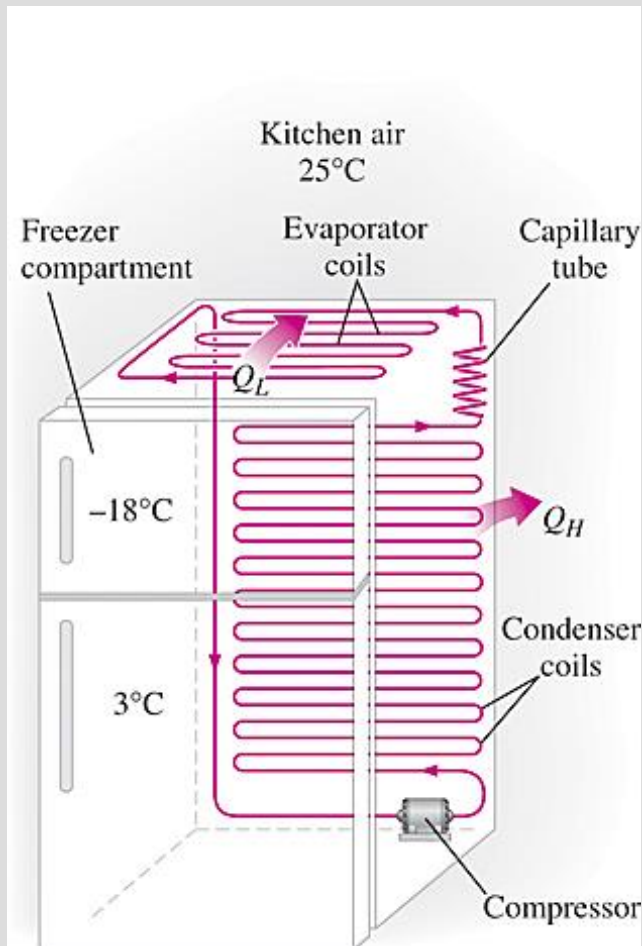

An ordinary household refrigerator.

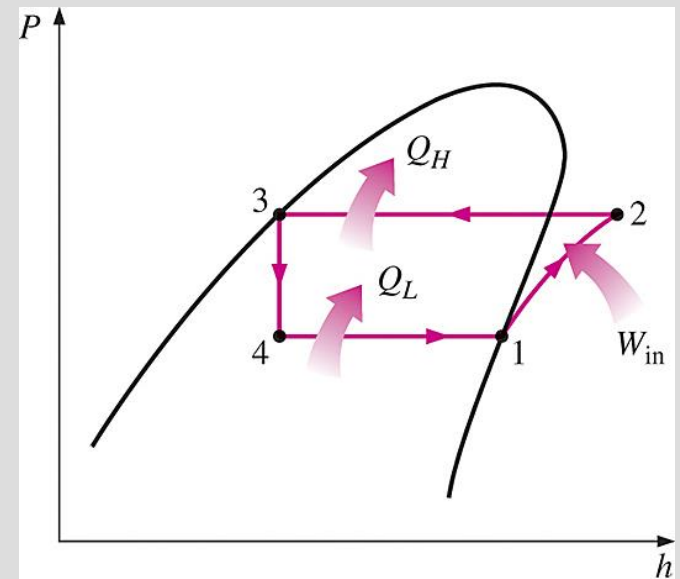

The P - h diagram of an ideal vapor-compression refrigeration cycle.

ACTUAL VAPOR-COMPRESSION REFRIGERATION CYCLE

An actual vapor-compression refrigeration cycle differs from the ideal one in several ways, owing mostly to the irreversibilities that occur in various components, mainly due to **fluid friction** (causes pressure drops) and **heat transfer to or from the surroundings**. **The COP decreases as a result of irreversibilities.**

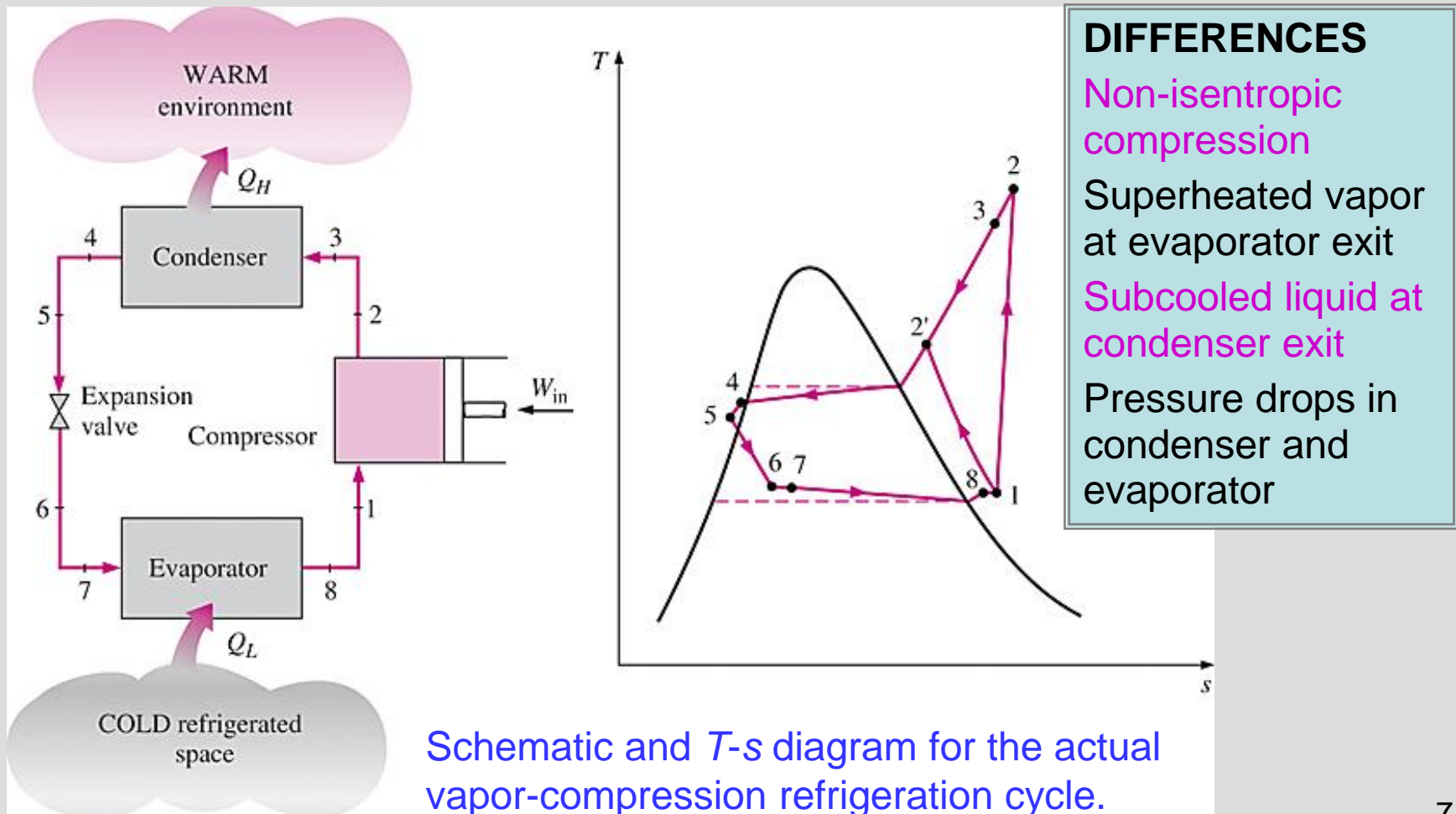

SELECTING THE RIGHT REFRIGERANT

- Several refrigerants may be used in refrigeration systems such as chlorofluorocarbons (CFCs), ammonia, hydrocarbons (propane, ethane, ethylene, etc.), carbon dioxide, air (in the air-conditioning of aircraft), and even water (in applications above the freezing point).
- R-11, R-12, R-22, R-134a, and R-502 account for over 90 percent of the market.
- The industrial and heavy-commercial sectors use *ammonia* (it is toxic).
- R-11 is used in large-capacity water chillers serving A-C systems in buildings.
- R-134a (replaced R-12, which damages ozone layer) is used in domestic refrigerators and freezers, as well as automotive air conditioners.
- R-22 is used in window air conditioners, heat pumps, air conditioners of commercial buildings, and large industrial refrigeration systems, and offers strong competition to ammonia.
- R-502 (a blend of R-115 and R-22) is the dominant refrigerant used in commercial refrigeration systems such as those in supermarkets.
- CFCs allow more ultraviolet radiation into the earth's atmosphere by destroying the protective ozone layer and thus contributing to the greenhouse effect that causes global warming. Fully halogenated CFCs (such as R-11, R-12, and R-115) do the most damage to the ozone layer. Refrigerants that are friendly to the ozone layer have been developed.
- Two important parameters that need to be considered in the selection of a refrigerant are the temperatures of the two media (the refrigerated space and the environment) with which the refrigerant exchanges heat.

HEAT PUMP SYSTEMS

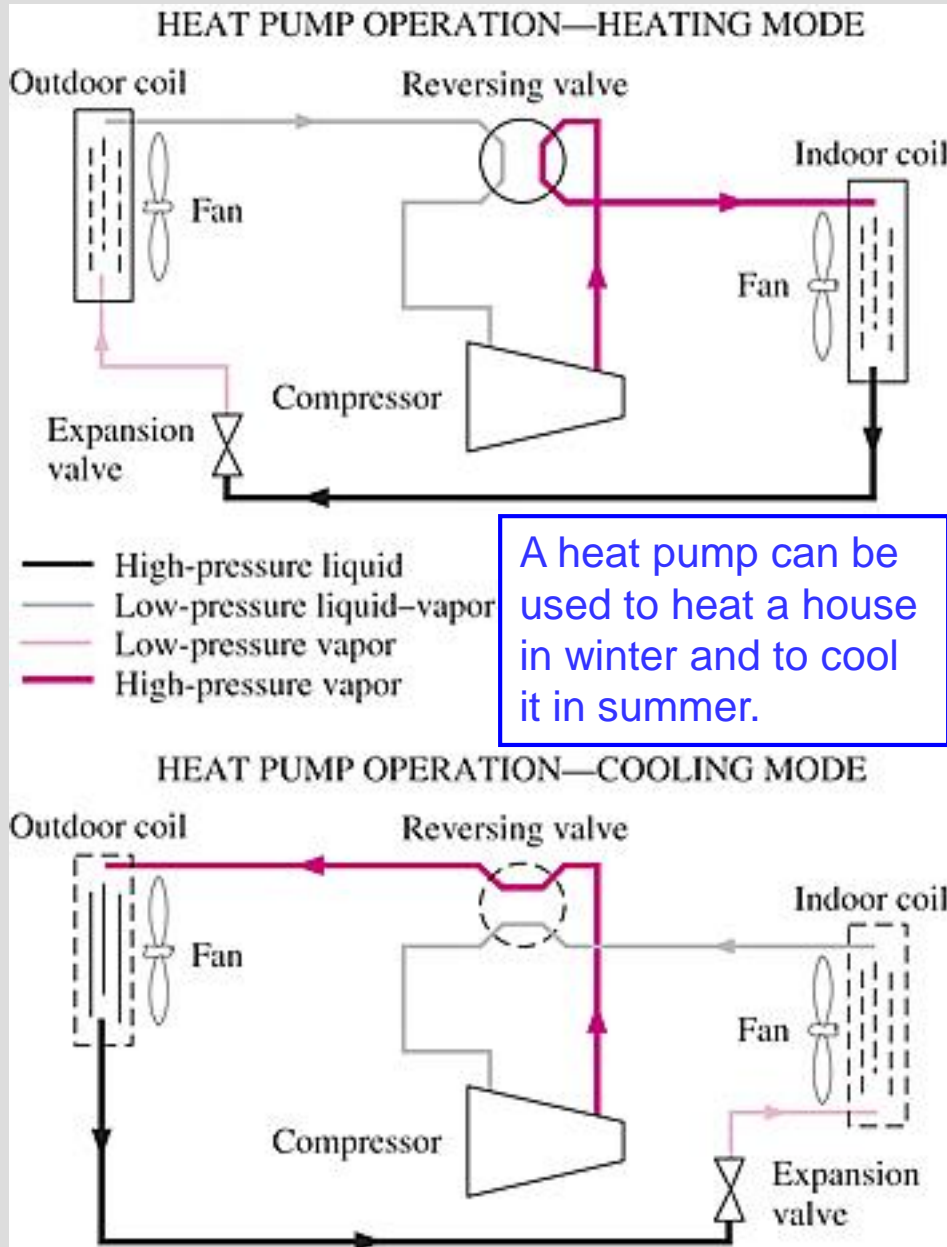

The most common energy source for heat pumps is atmospheric air (air-to-air systems).

Water-source systems usually use well water and ground-source (geothermal) heat pumps use earth as the energy source. They typically have higher COPs but are more complex and more expensive to install.

Both the capacity and the efficiency of a heat pump fall significantly at low temperatures. Therefore, most air-source heat pumps require a supplementary heating system such as electric resistance heaters or a gas furnace.

Heat pumps are most competitive in areas that have a large cooling load during the cooling season and a relatively small heating load during the heating season. In these areas, the heat pump can meet the entire cooling and heating needs of residential or commercial buildings.

INNOVATIVE VAPOR-COMPRESSION REFRIGERATION SYSTEMS

- The simple vapor-compression refrigeration cycle is the most widely used refrigeration cycle, and it is adequate for most refrigeration applications.
- The ordinary vapor-compression refrigeration systems are simple, inexpensive, reliable, and practically maintenance-free.
- However, for large industrial applications *efficiency*, not simplicity, is the major concern.
- Also, for some applications the simple vapor-compression refrigeration cycle is inadequate and needs to be modified.
- For moderately and very low temperature applications some innovative refrigeration systems are used. The following cycles will be discussed:
 - Cascade refrigeration systems
 - Multistage compression refrigeration systems
 - Multipurpose refrigeration systems with a single compressor
 - Liquefaction of gases

Cascade Refrigeration Systems

Some industrial applications require moderately low temperatures, and the temperature range they involve may be too large for a single vapor-compression refrigeration cycle to be practical. The solution is **cascading**.

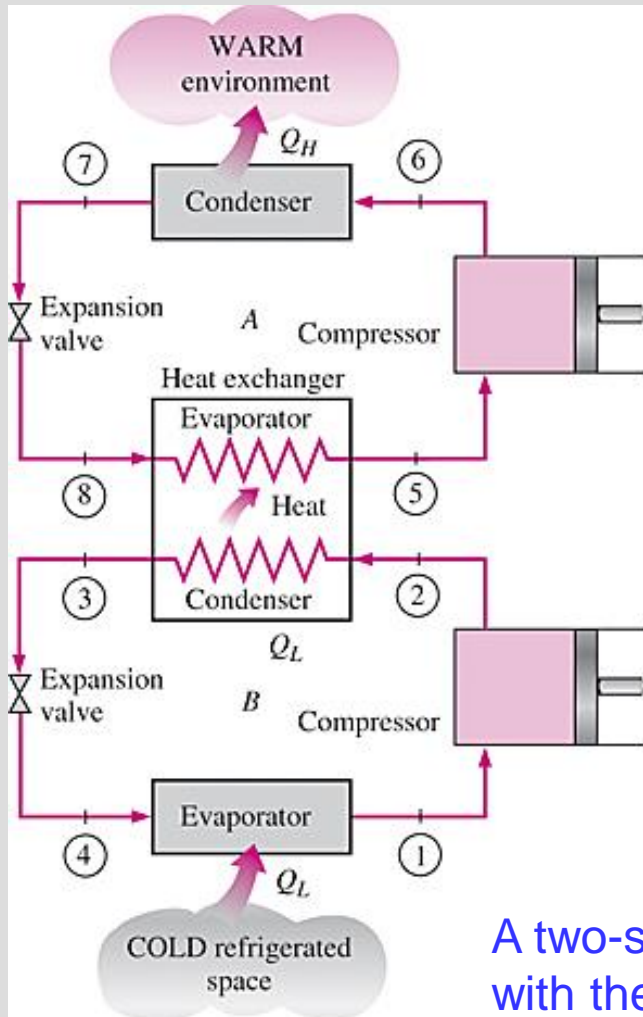

$$\dot{m}_A(h_5 - h_8) = \dot{m}_B(h_2 - h_3) \longrightarrow \frac{\dot{m}_A}{\dot{m}_B} = \frac{h_2 - h_3}{h_5 - h_8}$$

$$\text{COP}_{\text{R,cascade}} = \frac{\dot{Q}_L}{\dot{W}_{\text{net,in}}} = \frac{\dot{m}_B(h_1 - h_4)}{\dot{m}_A(h_6 - h_5) + \dot{m}_B(h_2 - h_1)}$$

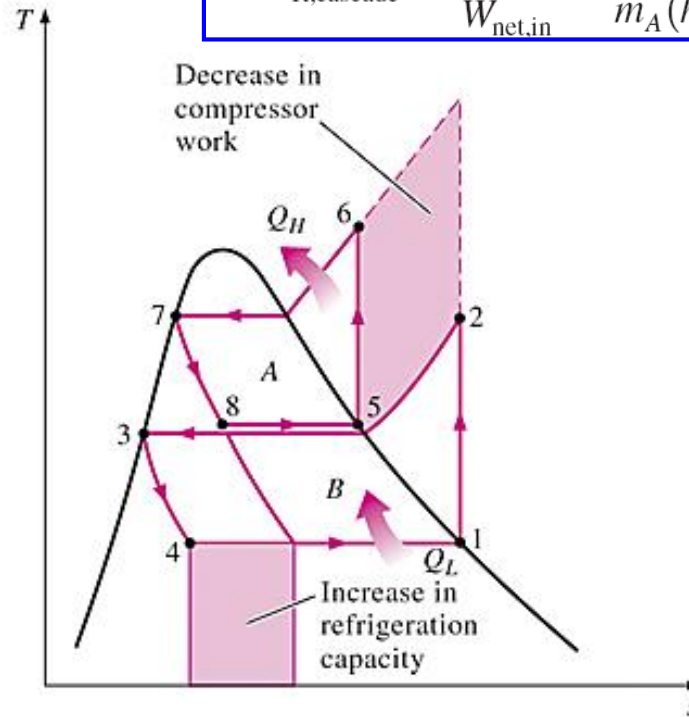

Cascading improves the COP of a refrigeration system.

Some systems use three or four stages of cascading.

A two-stage cascade refrigeration system with the same refrigerant in both stages.

Multistage Compression Refrigeration Systems

When the fluid used throughout the cascade refrigeration system is the same, the heat exchanger between the stages can be replaced by a mixing chamber (called a *flash chamber*) since it has better heat transfer characteristics.

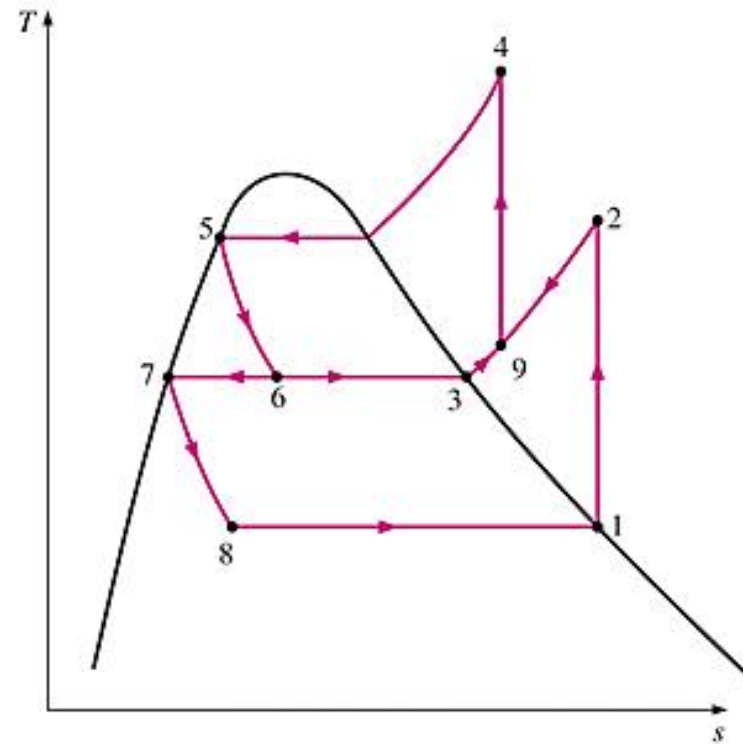
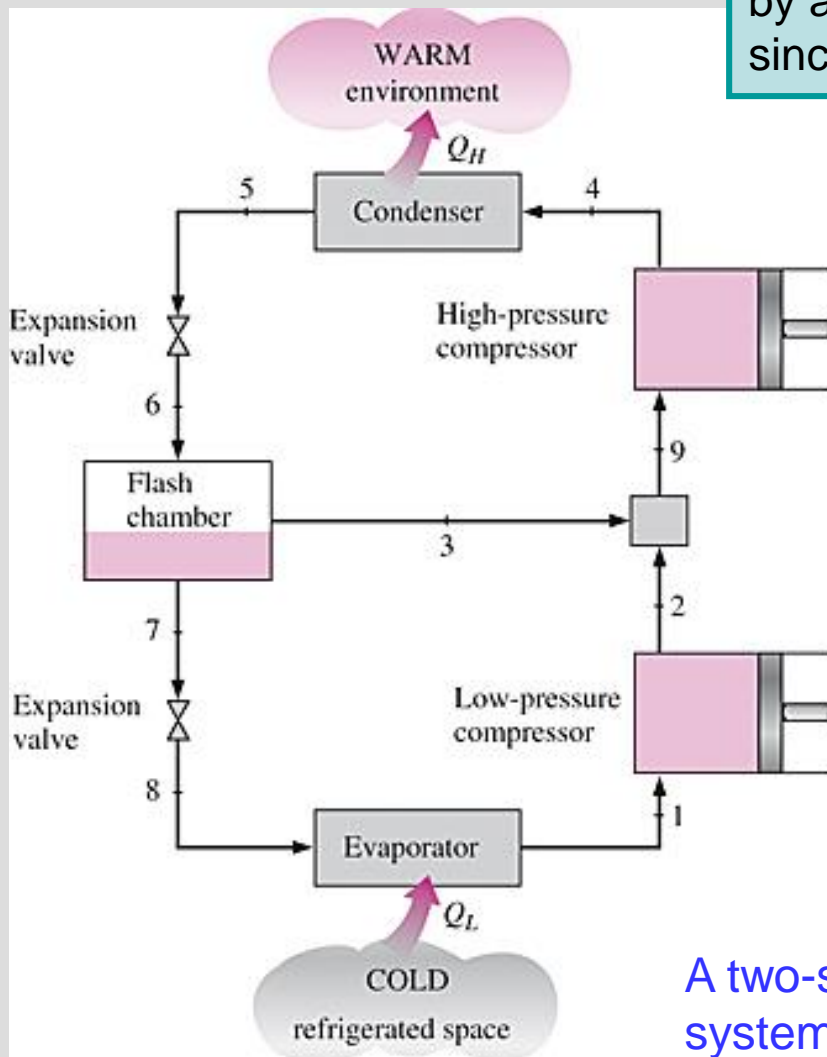

A two-stage compression refrigeration system with a flash chamber.

Multipurpose Refrigeration Systems with a Single Compressor

Some applications require refrigeration at more than one temperature. A practical and economical approach is to route all the exit streams from the evaporators to a single compressor and let it handle the compression process for the entire system.

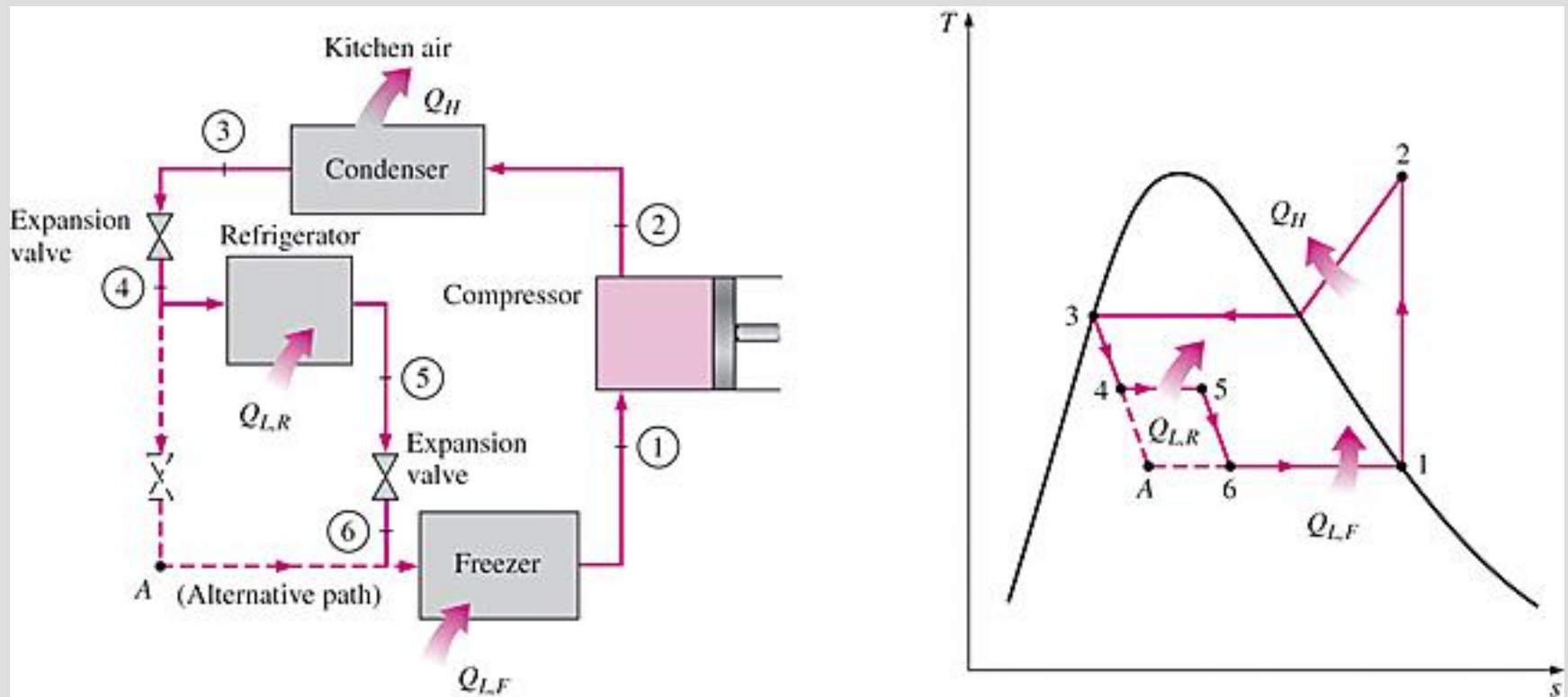

Schematic and T - s diagram for a refrigerator–freezer unit with one compressor.

Liquefaction of Gases

Many important scientific and engineering processes at cryogenic temperatures (below about 100°C) depend on liquefied gases including the separation of oxygen and nitrogen from air, preparation of liquid propellants for rockets, the study of material properties at low temperatures, and the study of superconductivity.

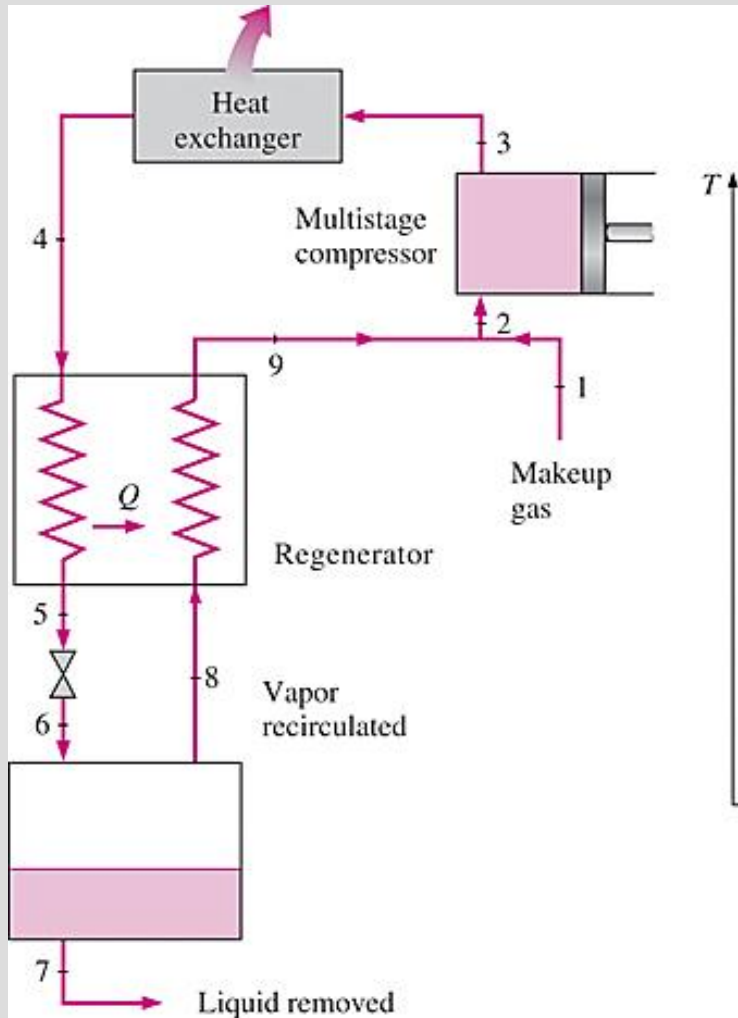

The storage (i.e., hydrogen) and transportation of some gases (i.e., natural gas) are done after they are liquefied at very low temperatures. Several innovative cycles are used for the liquefaction of gases.

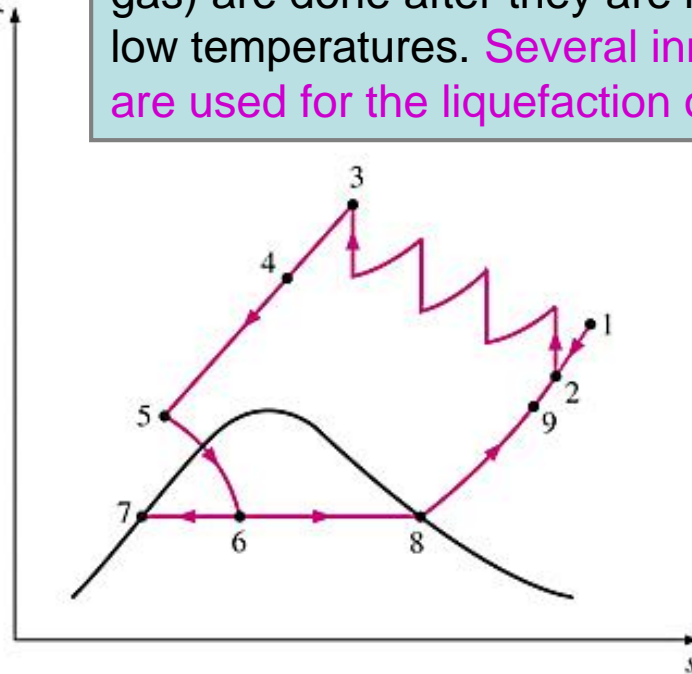

Linde-Hampson system for liquefying gases.

GAS REFRIGERATION CYCLES

The **reversed Brayton cycle** (the gas refrigeration cycle) can be used for refrigeration.

$$\text{COP}_R = \frac{q_L}{w_{\text{net,in}}} = \frac{q_L}{w_{\text{comp,in}} - w_{\text{turb,out}}}$$

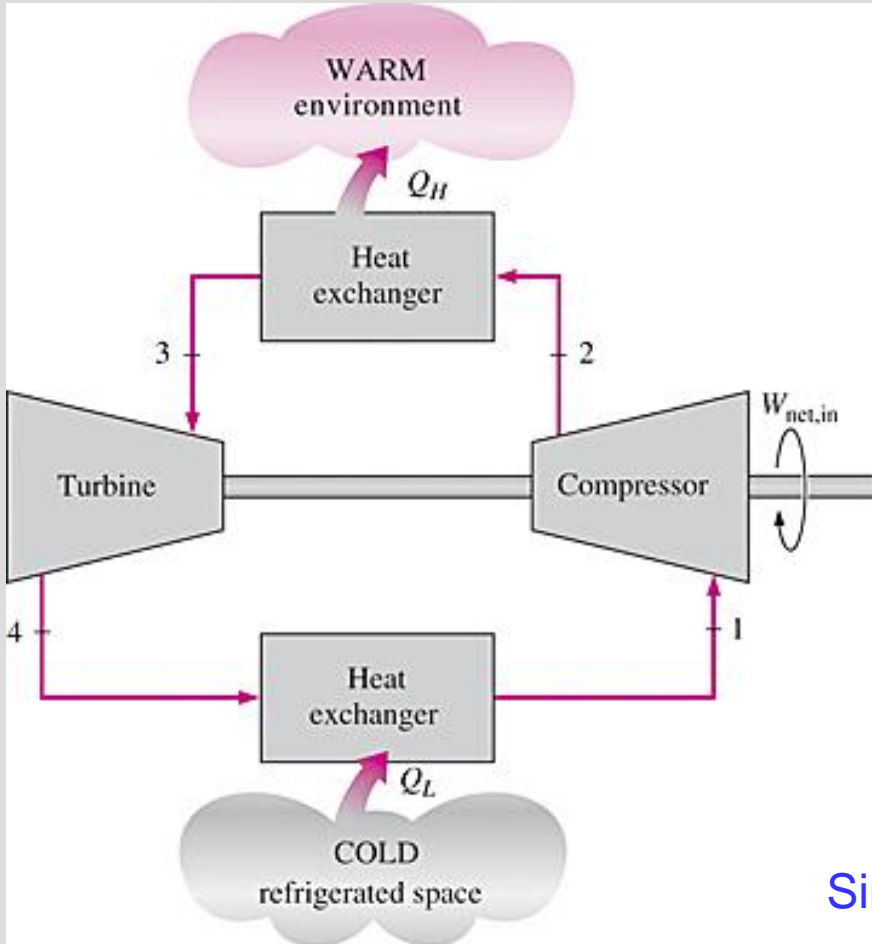

$$q_L = h_1 - h_4$$

$$w_{\text{turb,out}} = h_3 - h_4$$

$$w_{\text{comp,in}} = h_2 - h_1$$

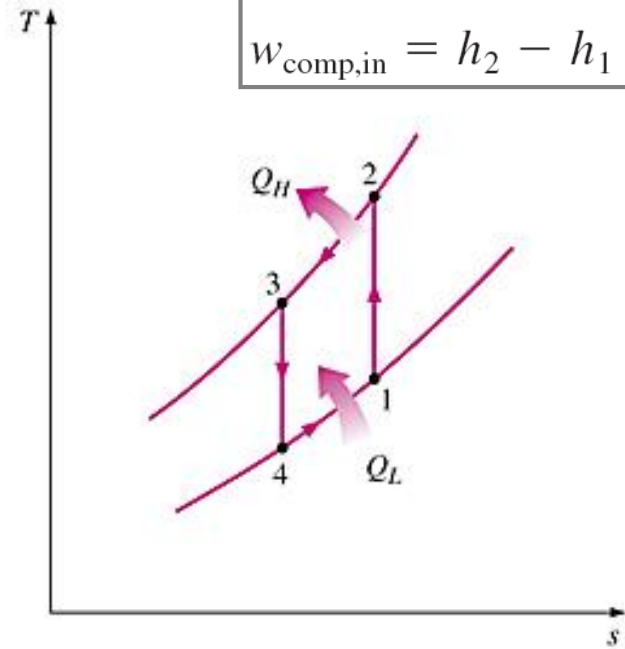

Simple gas refrigeration cycle.

The gas refrigeration cycles have lower COPs relative to the vapor-compression refrigeration cycles or the reversed Carnot cycle.

The reversed Carnot cycle consumes a fraction of the net work (area $1A3B$) but produces a greater amount of refrigeration (triangular area under $B1$).

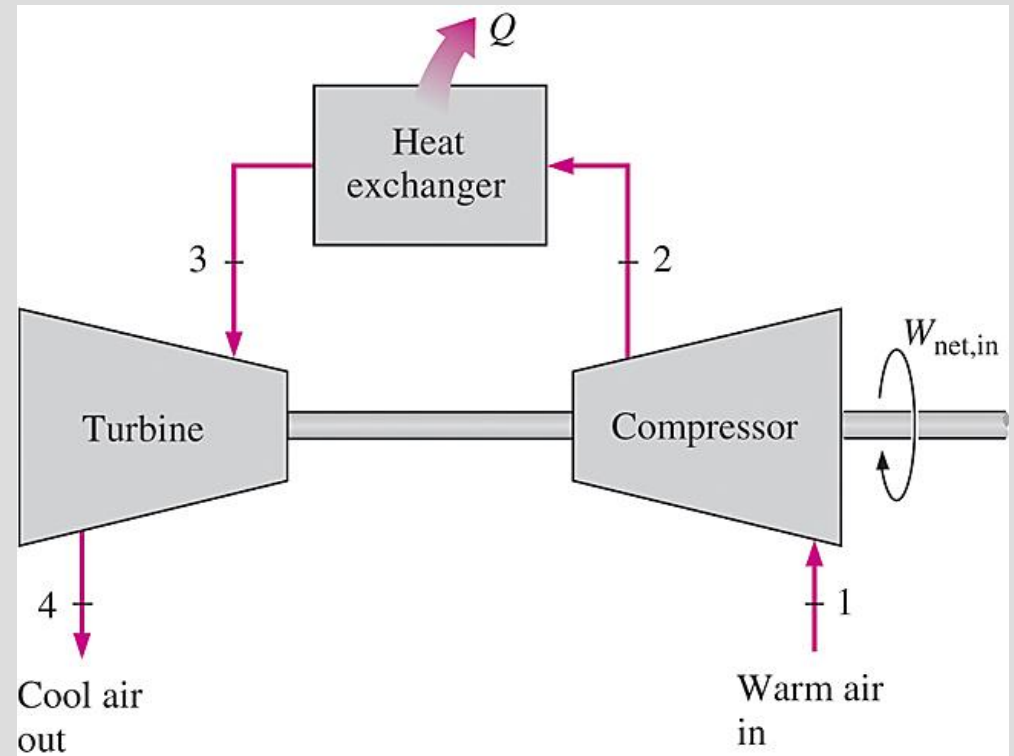
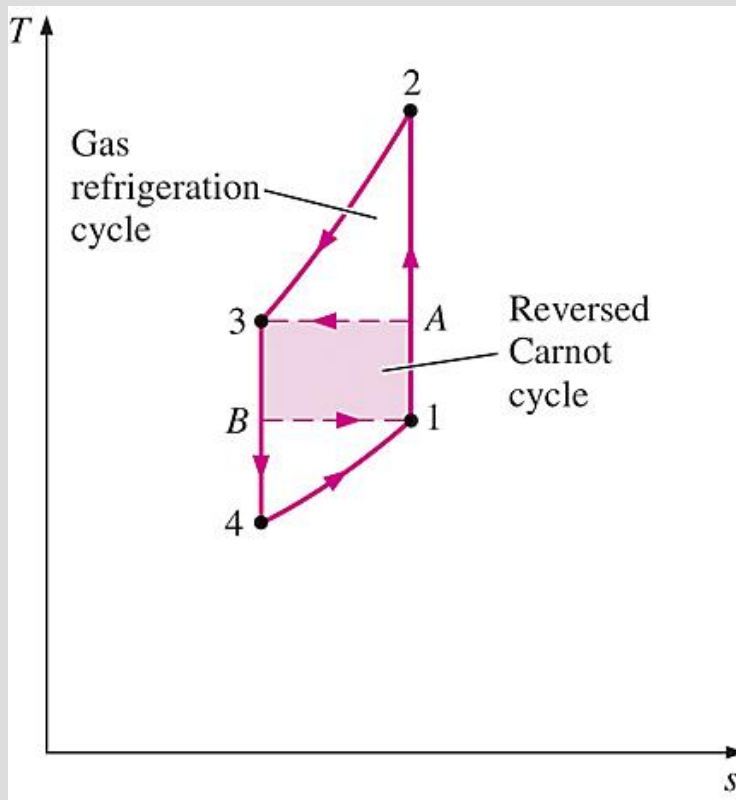

An open-cycle aircraft cooling system.

Despite their relatively low COPs, the gas refrigeration cycles involve simple, lighter components, which make them suitable for aircraft cooling, and they can incorporate regeneration

Without regeneration, the lowest turbine inlet temperature is T_0 , the temperature of the surroundings or any other cooling medium.

With regeneration, the high-pressure gas is further cooled to T_4 before expanding in the turbine.

Lowering the turbine inlet temperature automatically lowers the turbine exit temperature, which is the minimum temperature in the cycle.

Extremely low temperatures can be achieved by repeating regeneration process.

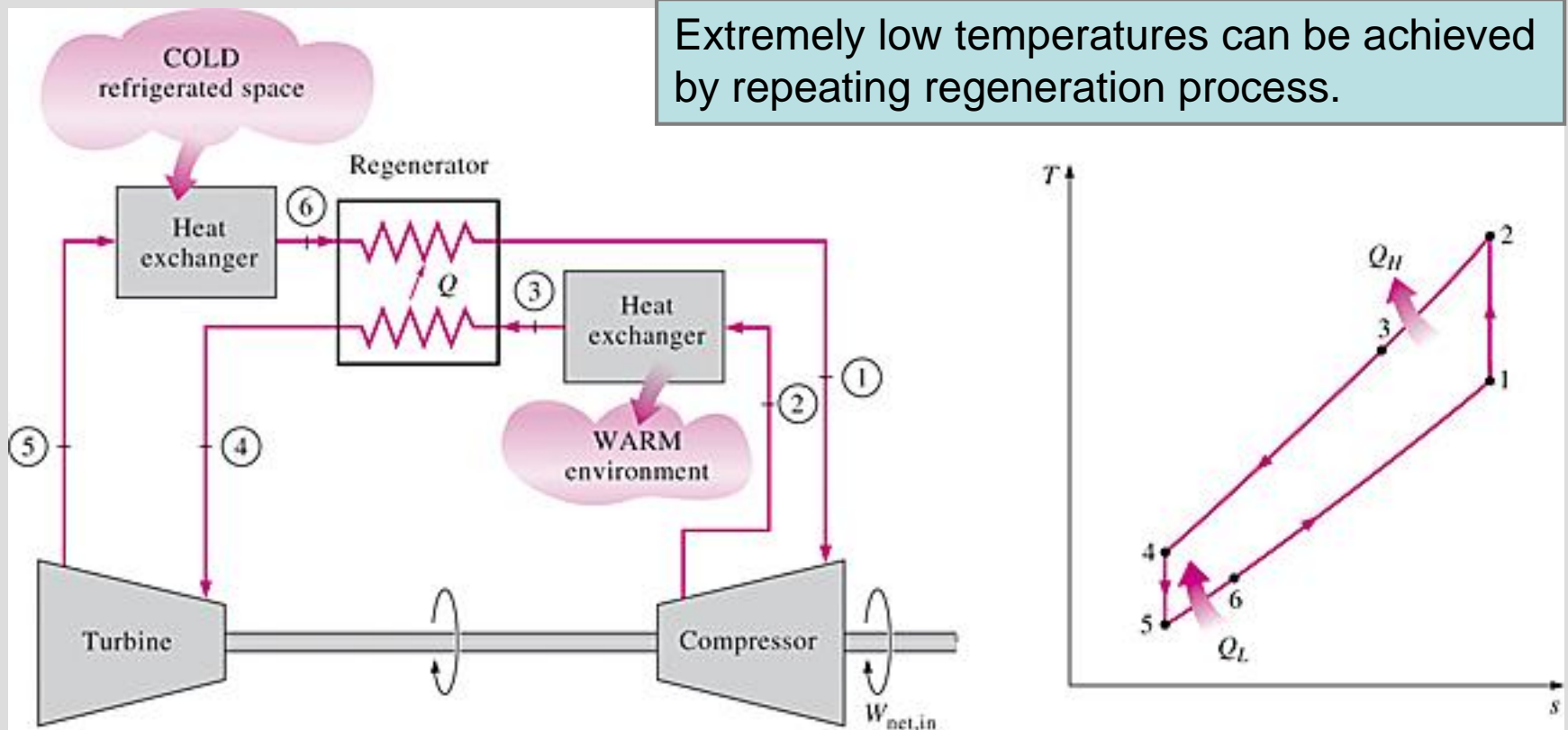

Gas refrigeration cycle with regeneration.

ABSORPTION REFRIGERATION SYSTEMS

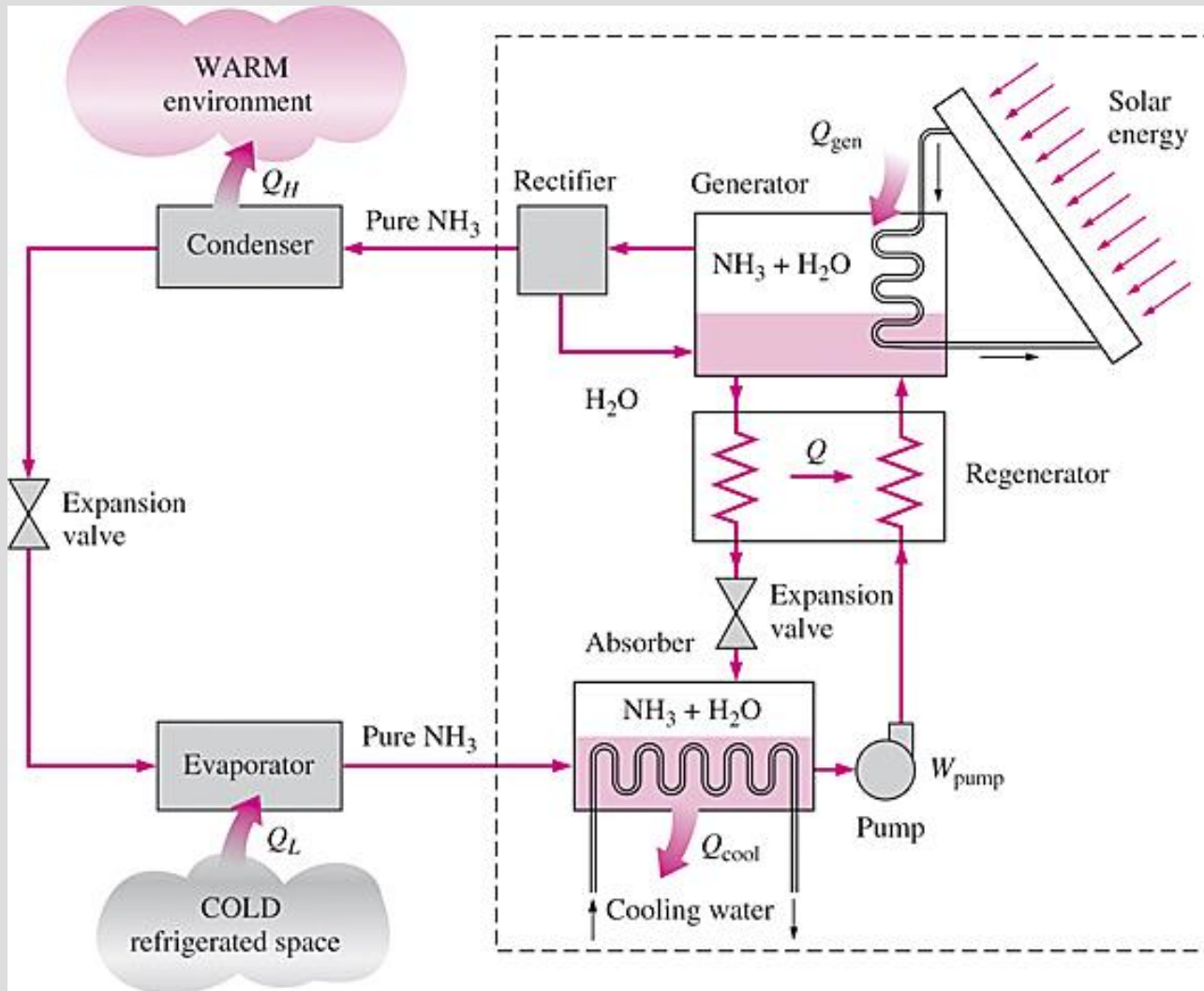

When there is a source of inexpensive thermal energy at a temperature of 100 to 200°C is **absorption refrigeration**.

Some examples include **geothermal energy, solar energy, and waste heat from cogeneration or process steam plants, and even natural gas when it is at a relatively low price.**

Ammonia absorption refrigeration cycle.

- Absorption refrigeration systems (ARS) involve the absorption of a *refrigerant* by a *transport medium*.
- The most widely used system is the ammonia–water system, where ammonia (NH_3) serves as the refrigerant and water (H_2O) as the transport medium.
- Other systems include water–lithium bromide and water–lithium chloride systems, where water serves as the refrigerant. These systems are limited to applications such as A-C where the minimum temperature is above the freezing point of water.
- Compared with vapor-compression systems, ARS have one major advantage: A liquid is compressed instead of a vapor and as a result the work input is very small (on the order of one percent of the heat supplied to the generator) and often neglected in the cycle analysis.
- ARS are often classified as ***heat-driven systems***.
- ARS are much more expensive than the vapor-compression refrigeration systems. They are more complex and occupy more space, they are much less efficient thus requiring much larger cooling towers to reject the waste heat, and they are more difficult to service since they are less common.
- Therefore, ARS should be considered only when the unit cost of thermal energy is low and is projected to remain low relative to electricity.
- ARS are primarily used in large commercial and industrial installations.

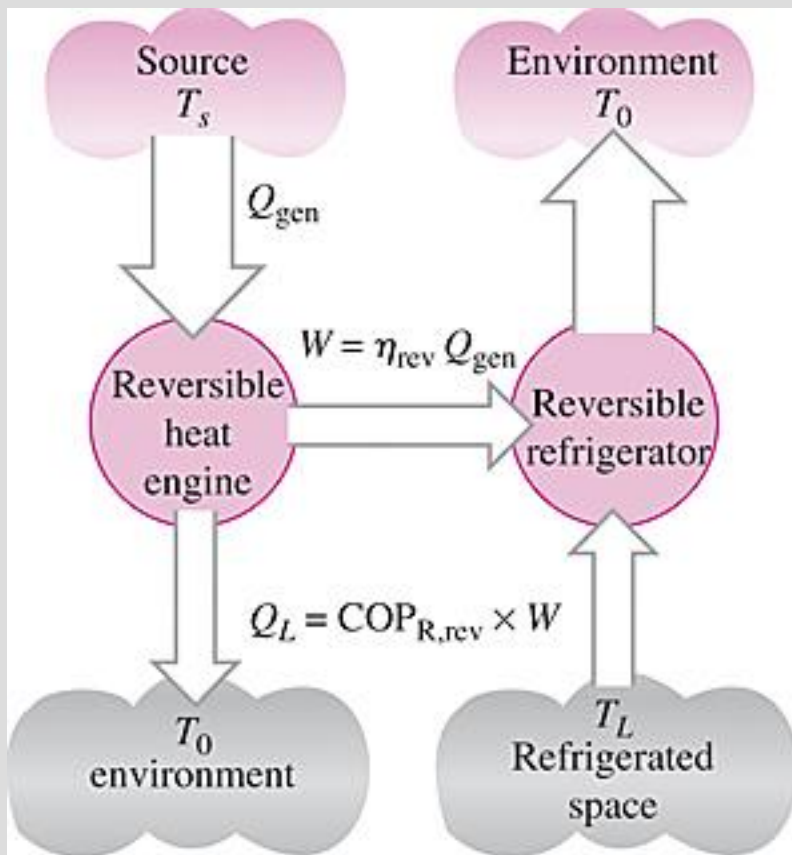

$$W = \eta_{\text{rev}} Q_{\text{gen}} = \left(1 - \frac{T_0}{T_s}\right) Q_{\text{gen}}$$

$$Q_L = \text{COP}_{\text{R,rev}} W = \left(\frac{T_L}{T_0 - T_L}\right) W$$

$$\text{COP}_{\text{rev,absorption}} = \frac{Q_L}{Q_{\text{gen}}} = \left(1 - \frac{T_0}{T_s}\right) \left(\frac{T_L}{T_0 - T_L}\right)$$

$$\begin{aligned} \text{COP}_{\text{absorption}} &= \frac{\text{Desired output}}{\text{Required input}} \\ &= \frac{Q_L}{Q_{\text{gen}} + W_{\text{pump,in}}} \cong \frac{Q_L}{Q_{\text{gen}}} \end{aligned}$$

The COP of actual absorption refrigeration systems is usually less than 1.

Air-conditioning systems based on absorption refrigeration, called **absorption chillers**, perform best when the heat source can supply heat at a high temperature with little temperature drop.

Determining the maximum COP of an absorption refrigeration system.

Summary

- Refrigerators and Heat Pumps
- The Reversed Carnot Cycle
- The Ideal Vapor-Compression Refrigeration Cycle
- Actual Vapor-Compression Refrigeration Cycle
- Selecting the Right Refrigerant
- Heat Pump Systems
- Innovative Vapor-Compression Refrigeration Systems