

NONWOVENS ... ENGINEERED FABRIC SOLUTIONS

INDA Nonwovens Glossary

 **Association of the Nonwoven Fabrics Industry**

P.O. Box 1288, Cary, NC 27512-1288, (919) 233-1210 Fax (919) 233-1282, www.inda.org



NONWOVENS ... ENGINEERED FABRIC SOLUTIONS

INDA Nonwovens Glossary

 **Association of the Nonwoven Fabrics Industry**



P.O. Box 1288, Cary, NC 27512-1288, (919) 233-1210 Fax (919) 233-1282, www.inda.org

INDA is a registered trademark of INDA, Association of the Nonwovens Fabrics Industry



Graphic Design and Printing
Margaret Park
Printing by Design, Raleigh, NC

Copyright © 2002 INDA, Association of the Nonwovens Fabrics Industry. All rights reserved. This material may not be reproduced, in whole or in part, in any medium whatsoever, without express written permission of INDA, Association of the Nonwovens Fabrics Industry.



Acknowledgments



INDA would like to thank the following persons who helped in editing this Glossary of Nonwoven Terms & Technology.

Subhash Batra, Ph.D. – North Carolina State University

Michael Thompson – BBA Nonwovens

Edward Vaughn, Ph.D. – Clemson University

Larry Wadsworth, Ph.D. – University of Tennessee

Foreword

This is the first printing of INDA's glossary of nonwoven terms and technology. The nonwovens industry has grown and changed considerably since its beginning about 50 years ago. While the nonwoven industry has its roots in the traditional textile industry, it has grown and expanded with many new technologies that have little in common with its textile origins. The industry's vocabulary extended to include these new technical innovations and the many markets they serve, some of which were a direct result of the nonwoven industry. In view of the immense industry expansion, it was surprising to us that not a single source of industry terminology or glossary of terms existed. We decided to publish this glossary because we felt there is a growing need by academics, employees and those associated with the industry to have a clear understanding of industry terminology. We have attempted to include in this glossary all relevant words and terms that a person could encounter working within the nonwoven industry and some of its major end-markets.

The aim of this glossary is to include all nonwoven terms and many of those in related industries where nonwovens are converted. The information is easy to find with considerable cross-referencing of terms. We have included numerous illustrations of various nonwoven technologies to clarify descriptions. There has been considerable dialogue with industry persons and editors to determine the correct usage for all terms used. We thank them for their knowledge and efforts in the preparation of this glossary.

We consider this a suitable standard reference to the nonwoven industry's language. We hope this glossary will help those working within the industry and academics to familiarize themselves with the industry's terminology. We invite your comments.

Ted Wirtz

President of INDA

A a

Abrasion

The wearing or grinding away of any part of a material by mechanical action.

Abrasion resistance

The ability of a surface to resist wear by friction.

Absorption

A process in which one material (the absorbent) takes in or absorbs another (the absorbate). The liquid or a gas is absorbed into a porous substance and retained.

Accumulator

A temporary storage device used in a fabric production line that enables the line to continue producing fabric while the full wound-up roll of fabric is doffed and replaced by an empty wind-up roll. In operation, the fabric is festooned over two parallel series of rollers of which the top series is elevated and stationary and the bottom series is counterbalanced and able to move up and down. This accumulator is positioned between the production line output and the fabric wind-up. During doffing, when no fabric is being wound up and the roll removed, the bottom series of rollers starts to drop towards the floor thereby taking up output from the production unit. (See **J-Box** as an example of another system.)

Acetate fibers

A manufactured fiber in which the fiber-forming substance is cellulose acetate (Federal Trade Commission (FTC) definition). Acetate fibers are derived by treating pure cellulose, which has been extracted from vegetable matter and generally wood pulp or cotton linters, with acetic anhydride. The resulting product is dissolved in acetone and extruded into filaments and the acetone evaporated. Acetate fibers are moderately strong, generally soft and lustrous like rayon. Acetate staple and filament fibers are more commonly used in weaving operations supplying end-markets such as lingerie, blouses, dresses, men's ties and other apparel. Acetate consumption by the nonwoven industry is relatively low.

Acetone

Colorless liquid used as an organic solvent.

Acquisition and distribution layer, also referred to as sub-layer

A nonwoven wicking layer under the top sheet (or face fabric) of an absorbent product, which speeds the transport and distribution of fluids throughout the absorbent core.

Actinic degradation

Deterioration of physical and aesthetic properties of fibers and fabrics due to exposure to light.

Activated carbon

A form of carbon capable of removing certain gases from air or impurities from water. Carbon is obtained from certain materials, generally of vegetable origin, and activated to produce a porous structure with a large surface area and adsorptive properties.

Additives

Chemicals added or incorporated into materials to give them different functional or aesthetic properties, such as flame retardancy and softness.

Adhesion

The force that holds different materials together at their interface.

Adhesive migration

The movement of adhesive in a fabric during drying or curing, to give it a non-uniform distribution within the web usually increasing to the outer layers.

Adsorbent

It is the material to which a molecule is attached and retained.

Adsorption

The attraction and adhesion of gaseous or liquid molecules to the surface of a solid. The strength of the bond depends on the van der Waal forces between two molecules.

Aerosol

Small particles, solid, semi-solid or liquid suspended in the air. The diameter of the particles may vary from 100 microns down to 0.02 microns. Examples are dust, smoke and fog.

Aesthetics

Properties of fabrics perceived by touch, sight, smell and sound. Examples are hand, drape, texture, rustle, color and odor.

Afterglow

The flameless, ember-like burning of a material after the external ignition source is removed.

After treatment (Finishing)

Chemical or mechanical processes carried out after a web has been formed and bonded to enhance functional or aesthetic properties. Examples are embossing, crêping, softening, printing and dyeing. The term also includes slitting to narrower widths and rewinding to desired roll lengths.

Agglomeration

A cluster of particles or fibers.

Aging

Process in which products are exposed to environmental conditions, that stimulate real use or accelerated use, for the purpose of determining their effect on the functional and aesthetic properties of the products.

Air filter

A device for removing contaminants from an air stream.

Air forming

See **Air laid**.

Air laid nonwoven

An air laid web that has been bonded by one or more techniques to provide fabric integrity.

Air laid pulp

An air laid nonwoven that is produced with fluff, wood pulp. The web can be bonded with resin and/or thermal plastic resins dispersed within the pulp.

Air laid web

A web of fibers produced by the air laid process.

Air laying, Air laid process

A nonwoven web forming process that disperses fibers into a fast moving air stream and condenses them onto a moving screen by means of pressure or vacuum.

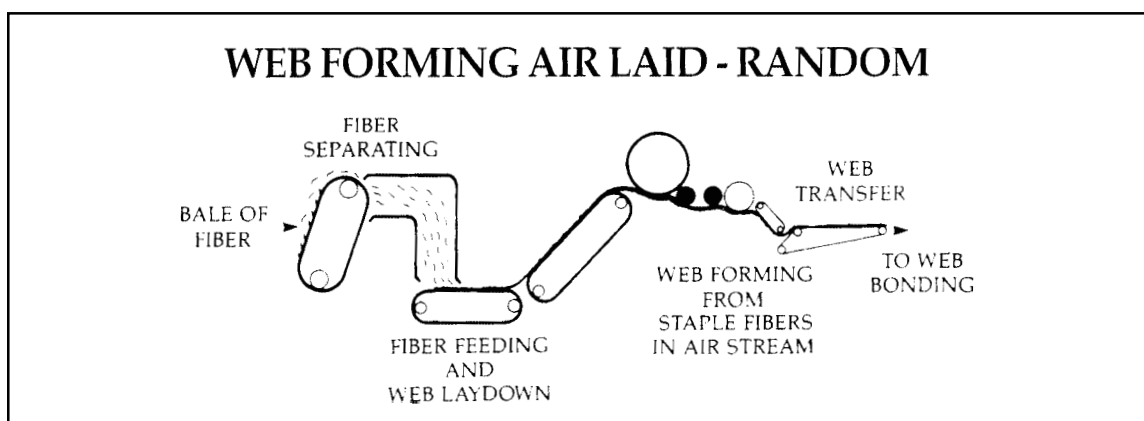

Air permeability

The rate at which air flows through a fabric.

Amorphous

Not crystalline. A random, rather than regular, arrangement of chains of molecules within regions of a polymer or fiber.

Anionic compound

A chemical carrying a negative electrical charge.

Anisotropic

Not having the same physical properties in every direction. In the plane of a fabric, it is related to a non-random distribution of fibers.

Antifelting agents

Products that minimize matting of textile materials.

Antifoaming agent

An additive that minimizes the formation of bubbles within or on the surface of a liquid by reducing the surface forces that support the bubble's structure. See **Surface Tension**.

Antioxidant

An additive that retards the deterioration of a material's functional and aesthetic properties resulting from its reaction with the oxygen in air.

Antisoiling properties

The ability of a textile to resist the deposition of dirt, making it easy to remove the dirt. Antistaining is a similar ability for oil or waterbound stains.

Antistat

An additive that reduces the accumulation or assists the dissipation of electrical charges that arise during the processing of fibers, fabrics and films, and during the use of products.

Arachne machine

A machine that stitchbonds a nonwoven using a knitting stitch.

Aramid fiber

A synthetic fiber made from a long chain of synthetic polyamide molecules. There are two main fiber types: polyamide 6, usually marketed under the Perlon name and polyamide 6.6 (often referred to as 66) referred to as Nylon. Other types of polyamide fibers have developed, but volumes are low. The numbers indicate how many carbon atoms are in each basic molecule of which the polyamide is made. Aramids were the first synthetic fibers developed: polyamide 6 in Germany and polyamide 6.6 in the United States. The main physical properties of aramid fibers are high strength, abrasion resistance, good elasticity and resistance to many solvents.

ASHRAE

The acronym for American Society of Heating, Refrigeration and Air Conditioning Engineers. Most air and liquid filter manufacturers in the United States use the ASHRAE test methods. Filter producers and consumers in many countries around the world follow the ASHRAE procedures.

Asphalt overlay

A type of geotextile fabric used in the resurfacing of older roads. In the process, the old layer of road has a layer of tar sprayed on the surface and then the nonwoven asphalt overlay is put on top of the surface while it is still tacky. Subsequently, a new asphalt surface is layered on top. The nonwoven's purpose is to prevent water from seeping from below the surface to degrade the surface and to spread the load of cars and trucks to a wider area.

ASTM

The acronym for American Society for Testing and Materials International.

Bb

BLC

See **Barrier Leg Cuff**.

Back coating

An adhesive type substance applied to the back side of a fabric for the purpose of locking pile yarn into a carpet backing, or bonding a secondary backing to the primary backing, increasing fabric body or stiffness, or imparting flame retardency to the fabric.

Backing

A web or other material that supports and reinforces the back of a product such as carpeting or wallpaper.

Back sheet

The exterior surface of a baby or adult diaper – generally made of film. The current trend is to improve absorbent products' aesthetics by adding a nonwoven material to cover the film, giving the outside of the product a cloth-like hand.

Bacteriostat

Chemical additive that limits or prevents the growth of bacteria.

Bale

A compressed and bound package of fiber – the common shipping package for fibers.

Bale breaker

Opening equipment used to break open compressed bales of fiber into separated fiber clumps in preparation for carding.

Barrier leg cuff

The raised cuff, which is generally a hydrophobic cover stock, used in baby or adult diapers and designed to contain body waste in the core area.

Basis weight

The weight of a unit area of fabric. Examples are ounces per square yard and grams per square meter.

Batt

A collection of fibers assembled into a sheet suitable for needlepunching bonding by some method. The term is synonymous with web.

Batting

A soft, bulky assembly of fibers usually used for filling, formed by carding, garnetting, air laying or other means. Layered carded webs are sometimes called a batt.

Beam

In the context of the spunlaid technology, the term refers to the large beam that contains the fiber spinning dies. In textiles, the term refers to a large spool containing many separate fibers wound parallel to one another for use in warp knitting or weaving.

Beater

The machine that does most of the fiber separation and cleaning in the processes of picking and opening that occur before the fiber is made into a web.

Bicomponent (bico) fibers

Fibers made of two different polymers extruded into one filament (core within a sheath or side by side are examples). One type of bicomponent fiber is produced using two polymers so chosen that one component softens at a lower temperature to act as a binder while the other component maintains the web's structural integrity. A second type of bicomponent fiber is splittable and with some form of mechanical energy applied, such as the hydroentangled technology, will separate into finer denier fibers.

Binder

An adhesive substance used to bind a web of fibers together or bond one web to another. The adhesive can be in a solid form (powder, film or fiber), foam, or in liquid form (emulsion, dispersion, solution) to bond the constituent elements or enhance their adhesion.

Binder content

The weight of adhesive used to bond the fibers of a web together – usually expressed in dry weight as percent of the fabric weight.

Binder fiber

Fibers with lower melting points than other fibers with a higher softening point or non-melting fibers. Upon the application of heat and pressure, these fibers soften and adhere to other fibers in the web, thereby acting as a binder. Some binder fibers can be bicomponent. A solvent (e.g. water) can activate some binder fibers, which may not be thermoplastic.

Biodegradable

The ability of a substance to be broken down by bacteria.

Bleaching

Chemical treatment with compounds that release chlorine or oxygen to increase the whiteness of fibers and fabrics.

Blend

A combination of two or more fiber types in making yarn or fabrics.

Boardy

The quality of stiffness in describing the hand of a fabric.

Bonding

The process of combining a fibrous web into a nonwoven fabric by means of resins (e.g. adhesives or solvent) or physical (e.g. mechanical entanglement or thermal adherence). The bonding may be all over or restricted to predetermined, discrete sites.

Bond strength

Amount of force needed to separate layers in a laminated structure or to break the fiber-to-fiber bonds in a nonwoven.

Breaking length

The length of a strip of fabric or film whose weight is equal to the force needed to break it. It is calculated by dividing the force needed to break by the basis weight.

Bristles

Fibers with thickness greater than about 100 microns (500 mils).

Brownian movement

The random movement of small particles or aerosols suspended in a fluid caused by molecular bombardment and fluctuations about the particle.

Brushing

A finishing process where a system of spinning brushes with wire bristles lightly touch a fabric and raise a light nap. This brushing process is more commonly used to finish woven and knitted materials.

Bulking

Processes that develop greater fullness, volume and crimp in yarns and fabrics.

Burning rate

The speed at which a fabric burns. This can be expressed as the amount of fabric affected per unit time, in terms of distance or area travelled by flame, afterflow or char.

Bursting strength

The force needed to rupture a material by distending it with force or pressure.

Cc

Calender

A machine used to bond sheets of fabric or film to each other or to create surface features on these sheets. It consists essentially of two or more heavy cylinders that impart heat and/or pressure to the sheets that are passed between them. The rollers can be mirror-smooth, embossed with a pattern or porous.

Calender bonding

Thermally bonding a web of loose fibers by passing them through the nip of a pair of calender rollers, of which one or both are heated. Plain or patterned rollers may be used. (see **Point Bonding**)

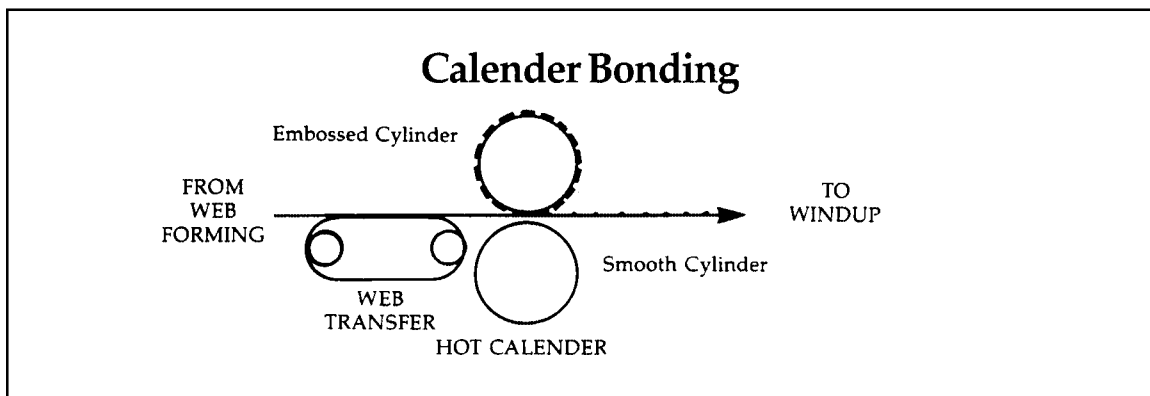

Calendering

A mechanical finishing process used to laminate and to produce special surface features such as high luster, glazing and embossed patterns.

Capacity

In terms of production, it is the maximum production output a machine is designed to deliver.

Card

A machine designed to separate fibers from impurities, align and deliver them to be laid down as a web or to be further separated and fed to an air laid process. The fibers in the web are aligned with each other predominantly in the machine direction. The machine consists of a series of rolls and drums that are covered with many projecting wires or metal teeth.

Card clothing

The wire teeth or serrated flutes that cover the working surfaces of a card.

Carded nonwoven

A nonwoven produced from a carded web that has been bonded by one or more technologies to provide fabric integrity.

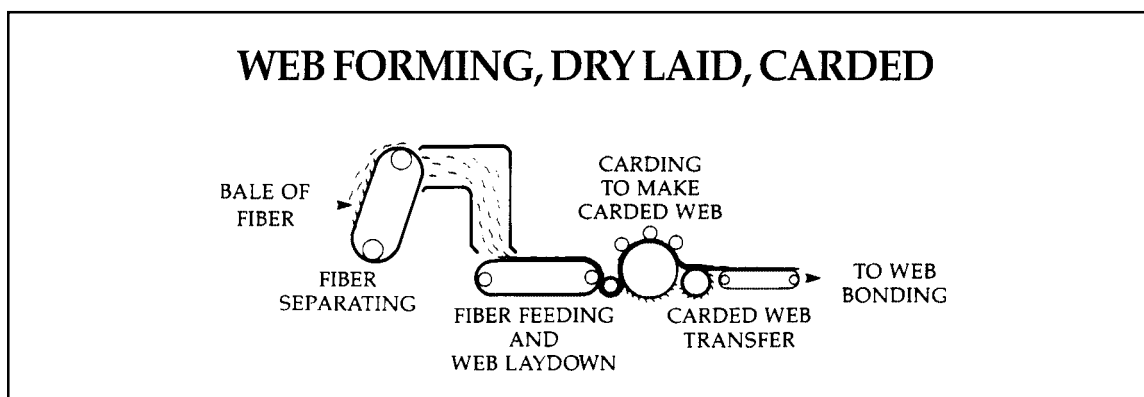

Carded web

A web of fibers produced by carding.

Carding

A process for making fibrous webs in which the fibers are aligned either parallel or randomly in the direction that the carding machine produces the web (see **Machine direction**).

Carpet

All textile floor coverings that are not designated as rugs.

Carpet backing

Support sheet on the back of a carpet through which the tufts are inserted or adhered. Primary backing is the principal material that holds the tufts. Secondary backing is occasionally applied on the underside of some carpeting to lock in the tufts and improve abrasion resistance, dimensional stability and strength.

Carpet underlay

A separate fabric that provides cushioning for the carpet.

Carrier web

A fabric which supports and facilitates moving a fibrous material through a processing stage.

Cartridge Filter

A disposable filter media which is generally long and cylindrical which is placed in a sealed filtration receptacle. The contaminated fluid flows from the outer edge of the filter to the inner hollow core on exiting but leaves its particles in the cartridge media.

Catalyst

A chemical that changes the rate of a chemical reaction, usually to speed it up, and is not consumed.

Cationic

A chemical carrying a positive electrical charge.

Cellulose acetate fibers

See **Acetate Fibers**.

Cellulosic fibers

Made from plants that produce fibrous products based on polymers of the cellulose molecule. Cotton plants produce separate cellulose fibers. Wood pulp is made by mechanically and chemically separating wood fibers. Rayon is made by dissolving vegetable matter, generally wood pulp, in a solution and extruding the solution through spinnerets into a chemical bath that regenerates the filaments. Some other cellulosic fibers are flax, jute and ramie.

CEN

Acronym for the Comité Européen de Normalisation or the European Committee for Standardization. The committee is charged with the responsibility to standardize the testing procedures of various European member nations.

Char

The flame affected part of a fabric after it has been burned.

Chemical bonding

See **Resin Bonding**.

Chemical finishing

Processes that apply additives to change the aesthetic and functional properties of a material. Examples are the application of antioxidants, flame retardants, wetting agents, and stain and water repellents.

Chemical properties

The response of a fiber to chemical environments such as acids, bases, or solvents.

Chips

Feed stock in the form of pellets or granules. Examples are polymers used in fiber or spunlaid production, wood pulp used in rayon production and wood chips used to make pulp.

Chlorine retention

The tendency of fabrics to retain chlorine after bleaching.

Civil engineering fabrics

See **Geotextile**.

Clean room

An enclosed space or room with a ventilating system that cleans the air and reduces the concentration and size of airborne particles to certain levels.

Clothing

When used to describe a card or garnett machine, the term refers to the sawtooth wire covering that “clothes” the cylinders and combs the fibers.

Cloudy web

An uneven or irregular web that gives a cloud-like appearance.

Clump

A knot of fibers in a web resulting from improper separation of the fibers.

Coagulation

The precipitation of particles from their suspension in a liquid.

Coalescence

In a liquid-liquid dispersion, it is the joining together (or coalescing) of liquid particles to form larger drops.

Coform

The formation of a nonwoven web through the concurrent use of elements from at least two different web formation technologies.

Coating

Application of a liquid material to one or both surfaces of a fabric, which is followed by drying or curing.

Cohesion

The resistance of like materials to be separated from one another. Examples are: The tendency of fibers to adhere to each other during processing, the resistance of a web to being pulled apart, and the resistance of a component of a laminate to being torn apart when the adhesive interface in the laminate is being stressed.

Coir

Fiber derived from the outer husks of the coconut.

Colorfastness

The ability of a textile material to retain its color when exposed to conditions (washing, drycleaning, sunlight, etc.) that can remove or destroy color.

Combing

In carding, the part of the process that removes neps and aligns the fibers.

Comfort

The sense of well-being in wearing clothing that comes from characteristics such as hand, breathability, softness, light weight and warmth.

Commissioning

Term refers to the period of time during which a new production line goes through the various stages to bring it into commercial production. Some complicated technologies can take several weeks: checking electronics, hydraulics, metering systems, balancing drive systems, adding fiber or resins, etc.

Composite material

Combination of two or more distinct materials having a recognizable interface between them.

Composite nonwoven

Term used when the essential part of the composite can be identified as a nonwoven material. If the essential part can not be identified, the term composite nonwoven is used when the mass of the nonwoven content is greater than the mass of any other component material.

Condensation

Liquid or droplets that form when a gas or vapor is cooled below its dew point.

Contaminant

Any solid, liquid or gas which can adversely affect machinery, a system or person.

Conditioning

A process of allowing materials to reach equilibrium with the moisture and temperature of the surrounding atmosphere. The atmosphere may be a standard such as 65 percent relative humidity and 70 degrees Fahrenheit, for testing purposes or other conditions that are optimum for manufacturing or processing.

Continuous filament

See **Filament Fibers**.

Corona charge

An electrostatic charge applied to some filter media to increase the initial filtration properties of the filter. (see **Electret**)

Converter

An organization that takes nonwoven fabrics supplied in rolls and provides an intermediate processing step, such as slitting, dyeing, coating, chemical finishes and printing. The fabric is then shipped to the finished products manufacturer.

Cover

The degree to which a fabric hides an underlying structure.

Cover stock

A lightweight nonwoven material used to contain and conceal an underlying core material. Examples are facing materials that cover the absorbent cores of diapers, sanitary napkins and adult incontinence products. The term cover stock now refers generally to facing material (top sheet), barrier leg cuff, back sheet, acquisition/transfer layer and stretchy panels.

Creep

The increase in strain exhibited by a material when held at constant stress.

Crepe

A quality in a fabric imparted by wrinkling or embossing to give crimped surface and greater fabric bulk.

Crimp

The waviness of a fiber. Crimp amplitude is the height of the wave with reference to straight uncrimped fiber. Crimp frequency or level is the number of crimps per inch or centimeter. Crimp energy is the work needed to straighten out a crimped fiber. Crimp percent is the length difference between the crimped and stretched out fiber expressed as a percent.

Crimp retention/stability

The ability of a fiber to maintain its crimp.

Cross machine direction

The width dimension, within the plane of the fabric, that is perpendicular to the direction in which the fabric is being produced by the machine.

Cross laid nonwoven

A cross laid web that has been bonded by one or more techniques to provide fabric integrity.

Cross laid web

A web of fibers formed by cross laying process.

Cross lapping

Process of layering a carded web on a conveyor, moving at right angles so the fibers are oriented in the cross direction increasing the cross directional strength of the fabric and the web weight.

Cross laying

Forming a multi-layered web on a conveyor belt by laying the web in a to and fro pattern at right angles to the direction in which the conveyor belt travels. The orientation of the fibers is dependent on the speed of the web delivery and the speed of the conveyor belt.

Cross-linking

The chemical reactions that create bonds at several points between polymers. These cause the polymers to be less soluble and to undergo changes in elasticity and stiffness.

Cross-section

The outline profile of a cut end of a fiber when it is cut perpendicular to its long axis. These profiles can be round, oval, irregular or complex regular shapes – depending on the shape of the die used to extrude the synthetic fiber, or for a natural fiber, depending on its growth pattern.

Crystalline

Orderly arrangement of molecules and polymer chains in a fiber or plastic.

CSR

The central supply room of a hospital from which supply items are distributed.

CSR wrap

The covering material wrapped around surgical instrument trays to maintain a bacterial barrier in the hospital's supply room storage area after sterilization.

Curing

A process by which resins, binders or plastics are set into or onto fabrics, usually by heating, to cause them to stay in place. The setting may occur by removing solvent or by cross-linking so as to make them insoluble.

Cylinder loading

The situation that occurs when fibers are imbedded so deeply in the wire clothing on a card cylinder that they resist transfer to the doffer cylinder according to the normal fiber path through the card.

Dd

Decitex (Dtex)

Weight in grams of 10,000 meters of a fiber. It is one-tenth of a tex (see **Tex**).

Defiberize (defibrate)

A process used to reduce fiber aggregates, such as wood pulp, into individual fibers. This is done by using hammermills or lickerins.

Defoaming agents

See **Antifoaming agents**.

Degradation

Deterioration of aesthetic and functional properties of a product – usually after being exposed for some time to heat, cold, light, or use.

Degree of polymerization

The average number of molecules (see **Monomers**) in a polymer.

Dehumidify

To remove water vapor from an airstream or from air in a space.

Delamination

Tendency of a fabric to be pulled apart (layer separation) by normal surface forces or shear tensions.

Delustrant

An additive that is used to dull the luster and to increase the opacity of a fiber or a fabric. The degree of delustering is termed semidull, dull and extra dull, depending on the amount of pigment added.

Denier

The measure of a weight per unit length of a fiber. Denier is numerically equal to the weight in grams of 9,000 meters of the material. Low numbers indicate fine fiber sizes and high numbers indicate coarse fiber sizes. The tex system is used in countries outside the United States. A tex is numerically equal to the weight in grams of one kilometer of fiber. It can be calculated by dividing the denier by nine.

Depth filter

A filter medium which is thick and captures particles within the media.

Diatomaceous earth

A filter media made from diatoms, which are fossils that collect at the bottom of sea beds in prehistoric seas. Also known as “kieselguhr,” the material is characterized by pores and cavities capable of capturing and retaining contaminants.

Diffusion

The movement of molecules or ions through a solution or material in response to differential concentrations or repulsive or attractive forces.

Dimensional stability

The ability of a fabric to maintain or resume its original geometric configuration.

DIN

Deutsches Institut für Normung or The German Institute for Standardization, which establishes standards for classifying and testing filters.

Dipping

Immersion of a textile in a finishing liquid (dip) such as dye or binder softener to improve its adhesion or water repellent properties.

Dispersion

A distribution of small particles in a medium. It also describes the uniform suspension of fibers in water for wet forming.

Disposables

A general classification of end-markets where the product made from the nonwoven has a relatively short life. Examples of some of the major categories are cover stock for baby diapers and sanitary napkins, wipes, fabric softener, medical apparel and associated items and filters.

Doff

1. (verb) The term used for removing a finished fabric from the machine: Doff the roll, or doffing the roll. 2. (noun) In some regions, the term also refers to the roll of finished material removed from the machine.

Doffer

The last cylinder of a card that takes the web of fibers that has been formed and removes it by a combing process (doffer comb) or rolls.

Doffer comb

An oscillating comb that is positioned close to the doffer roll to strip the travelling web away from the card.

Doffer loading

Refers to fibers firmly fixed or plugging the doffer roller's wire preventing the doffer comb from removing the web.

DOP

Diocetylphthalate (diethylhexylphosphate) is a viscous liquid that is heated into an aerosol in the critical particle range to challenge a filter. The aerosol's presence upstream of the filter and downstream are measured to determine the media's efficiency. DOP is used to measure HEPA and ULPA media performance.

Drape

The ability of a fabric to fold on itself and to conform to the shape of the article it covers.

Draw-through

An air circulating fan located downstream of the heating or cooling coils, humidifiers and filters in an HVAC system.

Drawing

A process of stretching a filament after it has been formed so as to reduce its diameter. The ratio of the final length to the initial length is called the draw ratio. Controlled stretching of the filament by a factor of 4 to 10 causes the molecular chains to become aligned (oriented) along the fiber axis and makes the filament stronger.

Dry spinning

The process in which a liquid polymer solution is passed through spinnerets into a heated air stream that drives off the solvent and coagulates the polymer into fibers. Sometimes referred to as Solvent Spinning.

Dry forming or dry laying

A process for forming a web from dry fibers by using carding equipment. Air laying refers to the formation of random webs with a stream of air.

Dry laid nonwoven

Dry laid web of fibers that has been bonded by one or more bonding techniques to produce a fabric with integrity.

Dry laid web

A web of fibers produced by the dry laying process.

Dry scrubbing

The process of removing heavy concentrations of gaseous contaminants from an airstream by the use of some specially designed adsorbers or chemisorbers.

Drying cylinders

Drying cylinders are used by the resin bonded process. The wetted, loose web is passed over the heated revolving cylinders to drive off the water leaving the cured resin that bonds the web.

Dumbbells

Defects common to wet-formed nonwovens, in which a “long” fiber entangles clumps of “regular” fibers. Typically, clumps are found at each end of the “long” fiber, giving it the appearance of a dumbbell.

Durables

A general classification of end-markets for nonwoven materials. The main characteristic of these markets is that the end products have a long life and are more or less permanent. The larger of these markets include apparel interlining, automotive, home furnishings and bedding construction materials, carpeting, geotextiles and roofing material markets. See also **Long-Life products**.

E e

Efficiency

The ability of a filter device or media to remove particulate of a certain size from a liquid or gaseous fluid by measuring the concentration of the particles upstream and downstream of the device or media.

Elasticity

The property inherent within a material to recover to its original shape after the force deforming the material is removed.

Elastomers

Polymers having qualities of stretch and recovery.

Electret

A microfiber filter media in which the fibers have more or less permanent electrostatic charge to attract and retain airborne dust particles. Electret filters can be reusable or disposable.

Electrical conductivity

A measure of the rate that an electrical charge travels from one point to another in an electric field.

Electrical resistivity

The resistance to the movement of an electrical charge.

Electronic air cleaners

These air cleaners electrostatically charge airborne dust particles as they enter the first stage of the device and then captures them as they pass through the second stage of the filter, carrying the opposite electrical charge.

Electrostatically laid web

A web produced by an electrostatic process.

Electrostatic web forming or laying

Forming a web of fibers, especially microfibers, by means of an electrostatic field from a polymer solution or emulsion, or from a polymer melt.

Elongation

The deformation in the direction of load caused by a tensile force. Elongation is generally expressed as a ratio of the length of the stretched material as a percentage to the length of the unstretched material. Elongation may be determined by the degree of stretch under a specific load or the point where the stretched material breaks.

Elongation at break

The point at which the last component of the stretched material breaks.

Embossing

A process whereby a pattern is pressed into a film or fabric, usually by passing the material between rolls with little clearance, and where one or both rolls has a raised design. At least one of the rolls is usually heated.

Emulsion

A suspension of finely divided liquid droplets within another liquid (see **Dispersion**).

Entanglement

A method of forming a fabric by wrapping and knotting fibers in a web about each other, by mechanical means, or by the use of jets of pressurized water, so as to bond the fibers. See **Hydroentangling**.

Exhaust air

Air removed from a space and not reused.

Extrusion

A process by which a heated polymer is forced through an orifice to form a molten stream that is cooled to form a filament or fiber. A solution of the polymer can also be forced through the orifice into a solvent that causes the fiber to solidify.

Ff

Fabric

A sheet structure made from fibers, filaments or yarns.

Face area

The area of a media used in air or liquid filters.

Facing

An outer covering of a product that is exposed during use or is placed against the body.

Fan

A device using blades for moving or producing artificial currents of air.

Felt (Nonwoven definition)

A sheet of matted fibers, most often wool or fur, bonded together by needlepunch and/or chemical processes and the application of moisture, heat and pressure.

Felt (Textile definition)

A woven fabric, generally made of wool, heavily shrunk or “fulled” by a combination of moisture, heat, chemicals and pressure so as to make it almost impossible to distinguish the weave.

Fiber

A unit of matter characterized by a high ratio of length-to-width. Material which can be spun into yarn or made into fabric by interlacing (weaving), interlooping (knitting), or interlocking (bonding). Discontinuous fibers are referred to as “staple fibers” with lengths designated in inches or millimeters. Typical textile fibers have length-to-width ratios in the order of 1000 to 1, are longer than one inch, have diameters greater than 10 microns, and mass-per-unit-length (linear density) values in the order of one gram per thousand meters.

Fiber distribution

In a web, the orientation (random or parallel) of fibers and the uniformity of their arrangement.

Fiber variant

A man-made fiber type derived through the use of additives or modification of the polymer chemistry or fiber surface. Fiber variants exhibit or emphasize specific properties and are intended for focused end-uses or specialized applications. The modification may consist of adding end or side groups to the fiber forming polymer, altering spin finish, changing spinneret geometry, or varying any combination of controllable manufacturing parameters.

Fiberfill

Low density fiber construction, used as filling and cushioning, for products like pillows, apparel and quilts made from synthetic fibers. The most common fiber used for fiberfill purposes is virgin polyester.

Fibrillate

The break up of a plastic sheet into a fibrous sheet. The term can also mean breaking fibers into smaller fibers, such as the splitting of a bicomponent fiber.

Fibrillated film

A type of fabric made from a process that embosses a film then stretches it in a controlled manner in the machine and cross direction to break open the film into small holes (fibrillate). The fibrillated film has a structure that resembles a fibrous nonwoven fabric. These materials can be used as cover stock, facings for supporting other nonwovens or as supporting scrim.

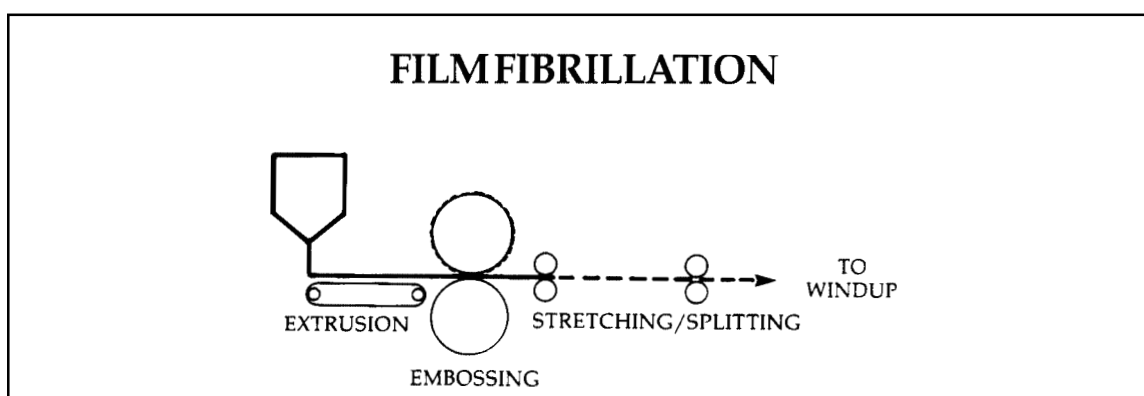

Filament fibers

Filaments are extruded fibers produced from a variety of polymers. Filaments are continuous fibers that are produced by forcing a molten polymer through a spinneret. If cut to a shorter length, say 3.8 cm, the term filament fiber changes to “staple” fiber.

Filament yarn

A yarn made of continuous filaments assembled with or without a twist.

Filler

A nonfibrous additive used in a fiber to increase its weight, replace more expensive polymer or change luster and opacity. It is also non-fibrous materials, such as insoluble clay, gypsum, starch or gum added to a fabric to increase its weight or appearance.

Filter fabric

A cloth used to separate particles from their suspension in air or liquids.

Filter media

Material that makes up the filter element. Media can be made of a variety of materials, woven metal, sand, fiber, ceramics, etc.

Finish

Substance added to fibers and textiles, in a post-treatment, to change their properties. Examples are lubricants and flame retardants.

Finishing

See **After treatment**.

Flame resistance

The property of a material to resist ignition, burn slowly or to self-extinguish after the ignition source is removed.

Flame retardant

A chemical used to impart flame resistance. The chemical can be added at the time the fibers are spun or added to the fabric through a finishing process.

Flammability

The characteristics of a material that describe the relative ease for a fabric to ignite and sustain combustion.

Flammability tests

Procedures used to determine the flame resistance and flame retardant properties of materials.

Flashspinning

A modified spunlaid technology in which a polymer/solvent solution is extruded under conditions that rapid solvent evaporation at the spinneret occurs. The individual filaments are disrupted into a highly fibrillar form and are collected on a moving screen to form a web.

Flashspun nonwoven

Webs of fiber produced by the flashspinning method and bonded together by one or more bonding techniques to provide fabric integrity.

Flashspun web

A web of fibers produced by the flashspinning process.

Flex abrasion

Abrasion of a sheet or fabric resulting from unidirectional flexing and frictional passage over a bar or other wear surface.

Flexural rigidity

The resistance of a fiber to bending (fiber stiffness), defined as the couple required to bend a fiber to unit radius of curvature.

Flocking

A method of applying a velvet surface to a material by dusting, or electrostatically attracting, short fibers onto an adhesive coated surface. The short fibers are made by grinding or cutting.

Foam bonding

A method for applying a resin to a loose web to bind the fibers. The resin is turned into a foam which then coats the fibers. An advantage of foam bonding is that little to no water is used in the binder thus requiring less heat energy and time to dry and cure the binder.

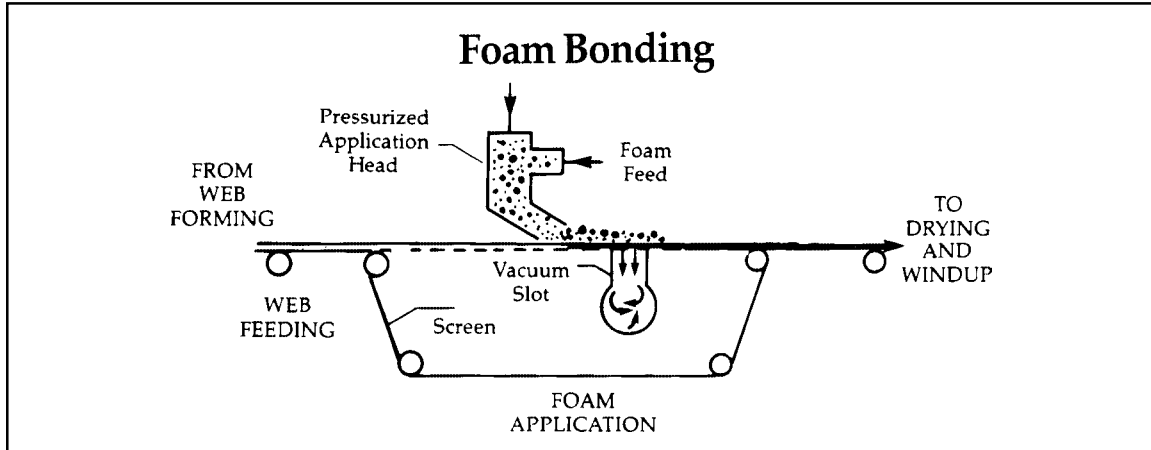

Foam machine

A machine used to generate foam. Foam is a means of adding a liquid to a web or fabric. Foamed latex binders are added to unbonded webs. Foamed finishes, such as hydrophilic finishes for cover stock, are applied by this method.

Foam spreader

The device used to spread the foam evenly across the width of the web.

Fog

An aerosol of fine liquid or semi-solid droplets in a gas.

Formed fabric

Another term for nonwoven fabric.

FPM

Feet per minute.

Fusing

Melting or bonding together of fibers or fabrics.

Fuzz

Untangled fibers that protrude from a fabric's surface or yarn.

Gg

Garnett

The garnett is a fiber processing machine with a series of sawtooth wires that are much coarser than found in a conventional carding system. The garnett process can reduce textile waste, old clothing and assorted natural fibers to a fibrous feed that can be needlepunched.

Gas

A fluid having extreme molecular mobility and no fixed dimensions. It diffuses and expands rapidly to occupy the space in which it is contained. It is the vapor or gaseous state of a substance.

Geogrid

A grid-like material made from various polymers with generally large openings. The material is used to stabilize soil, control erosion and occasionally used as fencing.

Geotextile

A permeable fabric used in civil engineering construction projects such as paving, dams, embankments and drains for the purpose of soil stabilization, sedimentation control, erosion control, support and drainage.

Glass fibers

Formed by extruding and attenuating molten glass. Glass fiber is brittle, which limits its use to a small number of markets. The fiber has the characteristics of withstanding relatively high temperatures of 280-300°C as well as poor heat conductivity and therefore major markets are heat insulation and high temperature filtration. Its characteristics of resistance to mildew, moisture and many oxidizing agents, solvents, alkalis and acids heightens its importance in those end-uses. The fiber also has good electrical resistance properties.

Grab strength test

A measure of the “effective strength” of a fabric; i.e., the strength of fibers in a specific width together with the additional strength contributed by adjacent fibers. Typically, grab strength is determined on a four-inch wide strip of fabric, with the tensile load applied at the midpoint of the fabric width through one-inch-wide jaw faces that are used to clamp the fabric.

Gravure printing or bonding

In the context of nonwoven web bonding, this refers to a method of bonding a web of fibers using the gravure method of printing. The gravure system uses a solid roller that is engraved with numerous small indentations. In the bonding process, the roller is partially immersed into an adhesive resin solution. As the roller turns, the excess solution is removed by a doctor blade, which leaves only the adhesive binder solution in the roller's indentations. An unbonded web is then squeezed against the gravure roller (generally by a rubber roller) and the resin penetrates the web by osmosis. The web is then dried to remove the water and the binder remains. See **Resin Bonding**.

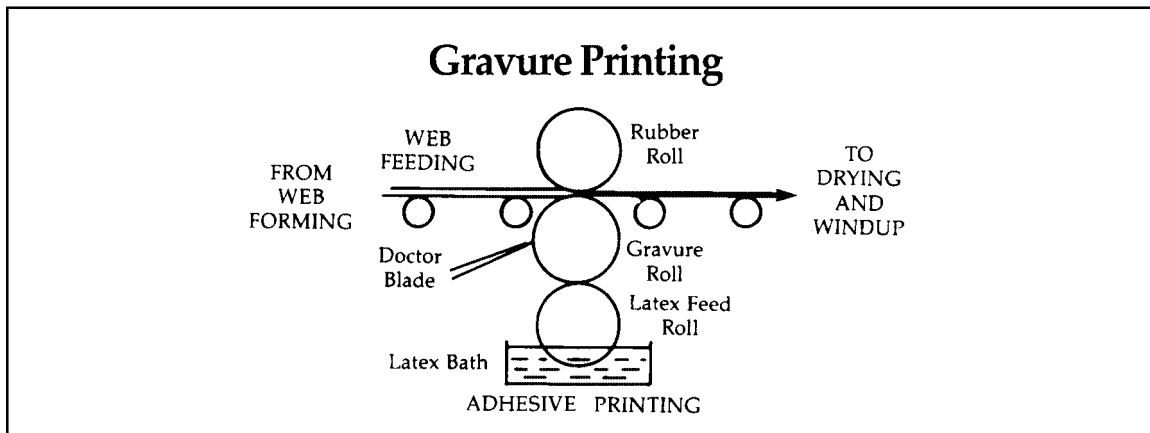

Gray fabric

Same as greige.

Greige fabric

Generally refers to woven or knitted fabrics off the loom prior to bleaching, dyeing or finishing treatment. The term is occasionally used to describe nonwovens before a finishing treatment.

gsm

Grams per square meter.

gsy

Grams per square yard.

Hh

Hammermill

A device used to defiberize cellulose pulp, generally available in roll goods form, to individual fibers (fluff pulp) by using high speed, rotating hammers.

Hand

Qualities of a fabric perceived by touch, e.g., softness, firmness, stretch, resilience and drape.

Heat resistance

The ability to resist degradation at high temperatures. The retention of useful properties when measured during heat exposure.

Heat setting

Process by which fibers, yarns or fabrics are heated to a final crimp or molecular configuration so as to minimize changes in shape during use.

Heat stabilized

The ability of a yarn or fabric to resist shrinking or stretching under mechanical or chemical stress. This property is obtained by prior heat-treatment or by use of a chemical additive.

HEPA filter

The acronym for High Efficiency Particulate Air. These filters are designed for filtering gases, normally air, to an efficiency of 99.97% by trapping particles down to 0.3 microns in the DOP test.

Highloft

General term for low density, thick or bulky fabrics, as compared to flat, paper-like fabrics. It is characterized by a high ratio of thickness to weight per unit area. Highloft battings have no more than 10% solids by volume and are greater than 3 mm (0.13 inch) in thickness.

Holes

Small perforations or openings of varying sizes in a fabric.

Hollow filament fibers

Manmade, continuous filament fibers, with voids created by introduction of air or other gas in the polymer solution or by melt spinning through specially designed spinnerets.

Hot-melt adhesive

A solid material that melts quickly upon heating, then sets to a firm bond upon cooling. Used for almost instantaneous bonding.

Housewrap

A layer of material used on new building construction to prevent air leakage, thereby reducing heating and air conditioning costs and increasing comfort. It is installed in the exterior walls of a new building construction prior to adding the building's final exterior. Housewrap is designed to be semi-permeable and allows water vapour to migrate through it thereby reducing the possibility of interior wall damage due to moisture build-up.

HVAC

The acronym applies to Heating, Ventilating and Air Conditioning systems that service air in an enclosed space, i.e., buildings, airplanes, cars, etc.

Hybrid

A nonwoven produced by incorporating the advantages of two or more nonwoven manufacturing systems to produce specialized nonwoven structures with properties unattainable by any single nonwoven process.

Hydroentangling, Hydroentangled

See **Spunlace bonding**.

Hydrophilic

Having an affinity for being wetted by water or for absorbing water.

Hydrophobic

Lacking the affinity for being wetted by water or for absorbing water.

Hydroscopic, hygroscopic

The ability to absorb moisture from the atmosphere, a property that fibers have in varying degrees.

Ii

Ignition

The beginning of combustion.

Imbibition

Liquid holding capacity of a fabric.

Impingement

The process in which particles are removed from an airstream because of the inertia. As an air containing particle flows toward a filter fiber or other collecting surface, the particle does not follow the air streamlines because of its inertia. Instead it moves in a straight line, colliding with the filter fiber or surface to which it may become attached.

Industrial fabrics

Textiles for non-apparel and non-decorative uses. Examples are wipers, cable wrappings and geotextiles.

Initial modulus

A material's resistance to small deformations, defined as the slope of the stress-strain curve at the origin and sometimes used to indicate fiber stiffness.

Instron tensile tester

High precision electronic test instrument that measures the elongation, tensile strength, tear strength or resistance to compression of materials while pulling or compressing forces are applied.

Interfacing (Interlining)

A fabric used in garments, to provide weight, thickness (or body) and stability.

Inertia

Any physical body persisting in its present state of rest or moving in a straight line motion unless acted upon by some external force.

ISO

Acronym for the International Standards Organization based in Switzerland.

Isotropic

A fabric having the same physical properties in every direction in the plane of a fabric. It is related to random distribution of fibers in a fabric.

Jj

J-box

A “J” shaped temporary holding or collecting area used in continuous fabric processing. The fabric from one piece of machinery is fed into the top of the J-box. The fabric fan folds and will be extracted from the bottom of the J to go into the next step of the process.

Jaws

The component of the clamp that grips the test material.

Jute

Soft fibers from the inner barks of certain tropical plants.

Kk

Knitted fabric

A fabric made from yarns or filaments that have rows of loops that interlock with the following row.

Knitting

A method of producing a fabric by interlocking a series of loops of yarns or filaments. There are two basic knitting methods:

Warp Knitting

A method of knitting in which the yarns or filaments run in the machine direction. This system uses large spools of yarns or filaments (warps). Three different methods of warp knitting are tricot, raschel and milanese.

Weft Knitting

A method of knitting in which one yarn or filament is interlooped with the previous course of loops made by the yarn. Circular knitting is a common method of weft knitting.

L

Laminate

A layered material containing two or more sheets bonded together with an adhesive, foam or thermoplastic resin.

Laminate nonwoven

A laminate of two or more layers of material in which the essential component is a nonwoven material.

Lap

A compressed sheet of fibers in a roll form, weighing about 50 pounds. The fibers are not bonded and are used to supply fibers to a card. Also called picker lap.

Lap splitting

A condition caused by a lap which will not unwind in carding in the same thickness as it was wound in picking. This splitting of the sheet of fiber can result in either a thicker or thinner sheet being fed into the card.

Latex

Either a naturally occurring milky appearing fluid from which rubber is made or a dispersion of a synthetic polymer in water. Typically used as binders.

Latex Bonding

See **Resin Bonding**.

Lengthwise

The machine direction in which the fabric is produced.

Lickerin

The name for a roller at the beginning of the fiber feed system of a card line. It is a high speed, saw-toothed wire roll that grabs the tufts of fibers fed into the system and deposits the partially opened fibers onto the main card cylinder.

Lickerin loading

A condition that can occur with the lickerin where fiber can become imbedded in the saw-toothed wire reducing the lickerin's ability to grab fiber and transfer it to the main card.

Limiting oxygen index

Measure of flammability that determines the minimum concentration of oxygen in a gas mix that is required to sustain steady burning.

Lint

Particles and short fibers that fall off a fabric product during the stresses of use.

Linters

Short cotton fibers not removed from the cottonseed after the spinnable fibers are removed on first pass through the gin. Linters are cut from the seed. Linters are used to make cellulose-based chemicals and rayon.

Loft

The properties of bulk and resilience of a fabric or batt.

Long staple

A long fiber. Typically used to describe the length of fibers used in the wet forming process by the paper industry.

Long-life nonwoven

Synonymous with Durable nonwoven.

Lubricant

An oil or other substance added to fibers to improve their processability in carding.

Mm

Machine direction

The long direction within the plane of the fabric that is in the direction in which the fabric is being produced by the machine.

Man-made fibers

Another term for synthetic fibers.

Married fibers

A term used to describe bundles of unopened fibers of a carded or spunlaid nonwoven. Married fibers are most noticeable in lightweight fabric.

Matrix

In the context of the nonwoven industry, this manufactured fiber is made from two or more dissimilar polymers combined before or during extrusion. These polymers separate into random components during extrusion. The bicomponent fibers could be used in through-air bonded processes.

Mechanical bonding

Bonding a web of fibers by entangling them. This can be achieved by needling, stitching them with fibers or by entangling them by high-pressure water jets.

Mechanical finishing

Changing the appearance or physical characteristics of a fabric by a mechanical process such as calendering, embossing, bulking, compacting and creping.

Media area

The total surface area of media used in the production of a filter. Net effective: The measure of usable media in a filter.

Medium

Medium is synonymous with filter material. “Media” is the plural of “medium.” It is common today to use media as the singular and “medias” as the plural.

Melt blowing

A nonwoven web forming process that extrudes and draws molten polymer resins with heated, high velocity air to form fine filaments. The filaments are cooled and collected as a web onto a moving screen. In some ways the process is similar to the spunbond process, but melt blown fibers are much finer and generally measured in microns. Melt blowing is a spunlaid process. The term is also spelled “meltblowing.”

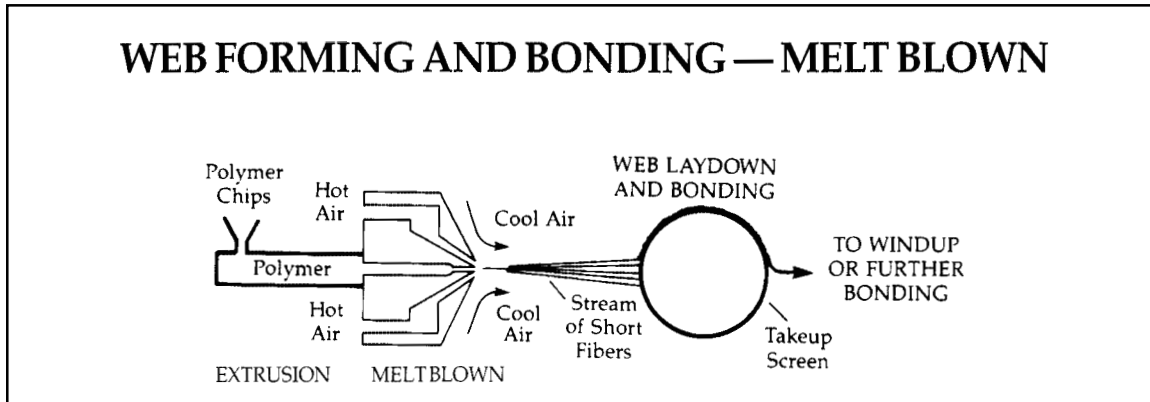

Melt blown nonwoven

A melt blown web that has been bonded by one or more techniques to provide fabric integrity.

Melt blown web

A web produced by melt blowing.

Melting point

The temperature at which a solid changes to the liquid state.

Melt spinning

The process of passing a liquid (molten) polymer through spinnerets and coagulating the material into fibers in a cooled air stream. See related processes: **Melt Blown, Flashspinning and Spunbond.**

Membrane filter

A permeable or semi-permeable membrane made of metal, polymer or other materials. These filters are capable of separating micron and sub-micron size particles from liquids and gases.

Meter (metre)

An SI linear measurement equal to 39.37 inches. Metre is the preferred spelling in many world regions. Multiply the value by 1.196 to convert square meters to square yards.

Metering pump

A component of the spinning process that measures the volume of molten polymer sent to a spinneret.

Methenamine test

A standard flammability test used to measure flame retardancy of traditional textiles and nonwovens. In a controlled environment, the methenamine tablet is ignited on the test sample and the amount of charring and burn is measured.

Micron

It is a unit of measure and equivalent to one millionth of a meter. In the context of nonwovens, the micron unit of measure is generally used to describe the width of low denier fibers, such as melt blown filaments. The abbreviated form is μm .

Mil

It is a unit of measure equal to one thousandth of an inch. Commonly used to measure the diameter of fibers and the thickness of films.

Mildew resistance

The degree to which fabrics are unaffected by certain fungi that cause odor and discoloration.

Mist

An aggregate of fine droplets of a liquid suspended in the air or a cloud of particles forming a haze.

Modulus

The amount of force it takes to stretch a material a unit distance. It is a measure of elasticity. An extensible material or fiber has a low modulus. Stiff materials have a high modulus.

Moisture content

The amount of moisture in a material expressed as a percentage of the material after drying.

Moisture regain (or Regain)

Percentage of moisture in a fiber or fabric after it is equilibrated in a standard humidity and temperature.

Mold

A variety of fungus growths commonly found on the surface of damp decaying organic matter or in warm moist places. It is characterized by a woolly or furry texture.

Molecule

The smallest part of an element or compound that can exist separately without losing its chemical properties.

Molten

A material in the liquid state or melted.

Monofilament

A single filament of fiber.

Monomer

A chemical compound that can be polymerized.

Morphology

Study of the fine, microscopic structure of a fiber or other materials, e.g., its crystalline and amorphous nature.

Nn

Nap

The soft raised fibers of a textile achieved by brushing the fabric.

Natural fibers

Fibers made directly from animals, vegetables or minerals. Examples are silk, wool, cotton, flax, jute, ramie and asbestos.

Necking

The narrowing of a fabric when stretched.

Needle

In the context of the nonwoven industry, the term refers to the barbed needle used by the needlepunched technology. The needles hook the fibers and perform the interlocking function. There are many variations in needle design, barb placement, barb angle, and barb shape depending upon the fiber and desired product outcome.

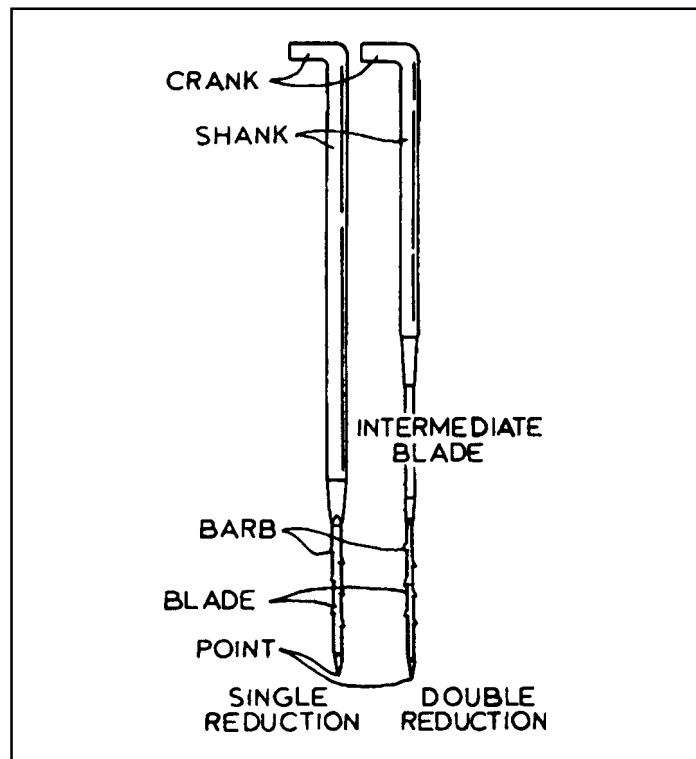

Needle beam

The component of the needlepunched technology that supports the needle board. The needle beam oscillates generally in an up and down movement penetrating the needle board into the web.

Needle board

In the needlepunched technology, the needle board is the part of the needle loom to which the barbed needles are anchored. The needle board is fastened to the needle beam.

Needlepunched or Needle punching

Mechanically binding a web to form a fabric by penetrating the web with an array of barbed needles that carry tufts of the web's own fibers in a vertical direction through the web.

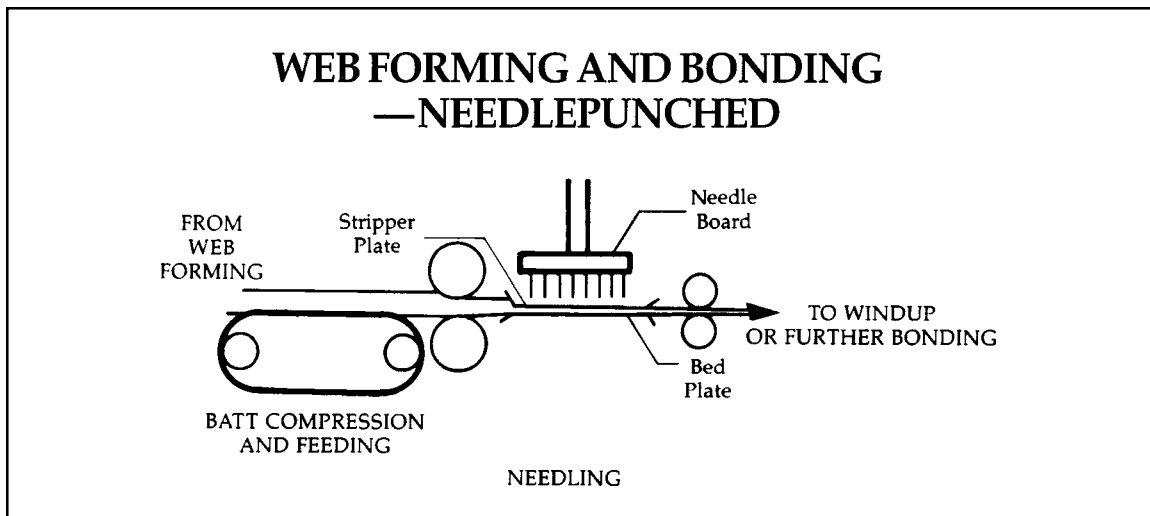

Neps

Small knots of tangled fibers that were not separated before forming the web.

Nip

The line of close contact between two calender rolls between which a fabric or web passes.

Nonwoven fabric

A fabric made directly from a web of fiber, without the yarn preparation necessary for weaving and knitting. In a nonwoven, the assembly of textile fibers is held together 1) by mechanical interlocking in a random web or mat; 2) by fusing of the fibers, as in the case of thermoplastic fibers; or 3) by bonding with a cementing medium such as starch, casein, rubber latex, a cellulose derivative or synthetic resin. Initially, the fibers may be oriented in one direction or may be deposited in a random manner. This web or sheet is then bonded together by one of the methods described above. Fiber lengths can range from 0.25 inch to 6 inches for crimped fibers up to continuous filament in spunbonded fabrics.

Nozzle

A term occasionally used in reference to the spinneret of a spunbond production line or fiber spinning system.

Nylon

See **Aramid**.

O o

Olefin fiber

Any synthetic fiber made from long molecular chains of propylene, ethylene or other olefins. These fibers are used widely by the nonwovens industry in disposable and durable end-uses, which include cover stock, automotive, geotextiles, medical apparel, home furnishings and bedding. See **Polypropylene fiber**.

Oleophilic

A substance that has an affinity to oil (see **Sorbent**).

Oleophobic

Opposite to the term Oleophilic. The substance has little to no affinity for oil.

On-stream

See **Start-up**.

Opener

See **Bale Breaker**.

Opening

A preliminary operation whereby staple fiber is separated sufficiently from its lap or baled condition so that it can be fed to the web forming part of the process.

Openness

A term describing how tightly or loosely packed a collection of fibers is in any space.

Optical brightener

A colorless compound that contributes whiteness to fabric. It does this by absorbing the ultraviolet component of light and emitting it as visible light.

Organic

Compound molecules that contain one or more carbon atoms.

Orientation

1. The lining up or parallelism of molecular chains in fibers and films. 2. The alignment of fibers in a nonwoven material.

Oshibori

A Japanese term referring to the pre-moistened hand towel (disposable or reusable) generally used before dining.

Overlap

Refers to the area where the web from one pass of a crosslapper lays over the edge of the previous lay.

Ozone

Ozone is a gaseous, unstable form of oxygen that is composed of three atoms rather than two. Ozone is a powerful oxidizing agent and is toxic even at low levels. It is a component of smog.

Pp

Padding

Applying a liquid or paste to a textile by dipping it in a bath or by passing it between squeeze rollers that carry the liquid or paste.

Parallel laying

Forming a web in such a way that the fibers or filaments are laid in directions roughly parallel with the machine direction.

Particle

A minute piece, part or portion of matter. It may be solid, semi-solid or liquid.

Particle count

The quantity of particles in a given volume of fluid.

Pascal

A metric unit of pressure used in measuring an air filter's performance.

Peak force

A term used in tear testing. It is the force required to break the fiber bonds of a nonwoven or other samples of textile materials.

Penetration

The flow of a liquid through pores, pinholes or holes resulting from imperfections or degradations of a fabric.

Penetration (filtration context)

A measure, in percent, of particles of a given size that pass through a filter. If no particles pass through then 100% were trapped. If 97% of particles are trapped, then penetration is 3% ($100\% - 97\% = 3\%$) and the filter is 97% efficient. Penetration is used to measure the performance of very high efficiency filters.

Permanent press

Treatment for garments that permits them to retain their shape, creases or pleats after laundering.

Permeation

The passage of liquids or gases through materials by absorption and diffusion on a molecular level and exiting as a gas.

Physical property

The response of a fiber to physical forces.

Picker

A machine that separates staple fiber and forms it into a lap, so it can be fed to a card.

Pigment

A colored or white substance that is insoluble and finely divided. Used to color or to deluster a fiber, fabric or plastic.

Pilling

The tendency of fibers to come loose from a fabric surface and form balled or matted particles of fiber.

Pinsonic thermal joining

A process which uses ultrasonic energy to bond layers of thermoplastic materials.

Plastic

A polymer with its additives. Also, the ability to be deformed and molded.

Plasticizer

Chemical that imparts flexibility, stretch and workability to a fiber or a plastic.

Pleating

The process of fan-folding materials to increase surface area. Commonly used for filter media to increase efficiency and reduce pressure drop.

Plies

Layers of web, fabric or components of a laminate.

Point bonding

Using heat and pressure in a discrete pattern to bind thermoplastic fibers to form a nonwoven fabric.

Polyester fiber

A manufactured fiber in which the fiber-forming substance is any long chain synthetic polymer composed of at least 85% by weight of an ester of dihydric alcohol and terephthalic acid (FTC definition). The physical properties of polyester fiber are excellent strength, high abrasion and resilience with good chemical resistance to acids, solvents and oxidizing agents. Major end-uses for polyester staple fiber are fiberfill, wipes, and durable nonwovens, such as geotextiles, automotive and carpeting. Spunlaid polyester is found in fabric softener substrate, automotive carpeting, modified bitumen roofing and various durable end-markets.

Polymer

A liquid or solid substance made by chemically linking macromolecules together in chains. High polymer denotes substances made from very long chains. Crosslinked polymer describes a substance in which there are molecular links between chains. Polymerization is the process for making these polymers.

Polymerization

The process of changing the molecular arrangement of a compound so as to form new compounds having the same percentage composition as the original, but of greater molecular weight and different physical properties.

Polymer laid nonwoven

See **Spunlaid**.

Polyolefin

A fiber made of long-chain polymerized olefin of at least 85% weight, from such monomers as ethylene, propylene or other olefins.

Polypropylene fiber

A manufactured, olefin fiber made from polymers or copolymers of polypropylene. One attractive physical characteristic of polypropylene is its specific gravity of less than one, which results in a larger area volume yield per kilogram or pound of resin or staple fiber compared to competitive fibers. Polypropylene has a relatively low melt temperature which restrict its uses in many nonwoven markets, but it has good strength properties, softness, and chemical resistance to strong acids and alkalis. Major nonwoven markets for staple and spunlaid polypropylene include cover stock, medical apparel and related, geotextiles, carpeting, blankets, automotive and various other durable markets.

Pounding

A process wherein a batt of fibers is repeatedly struck with a hammer-like device to drive wool fibers into the web resulting in entangling the fibers.

ppm

An abbreviation that refers to “parts per million.” It may be expressed by volume as ppm (v) or by mass as ppm (m).

Precipitation

The action of a solid or liquid separating from a solution because of a chemical or physical process or change that has rendered it insoluble.

Pressure drop

The pressure drop is the resistance to a fluid passing through a filter media at various flow rates.

Primary backing

The fabric into which a carpet is tufted.

Print bonding

Applying a latex resin binder to a web of fibers in a discrete pattern. See **Screen Bonding** and **Gravure Bonding** as the application methods.

Pulp

Short cellulose fibers made from wood or cotton.

Qq

QA

Acronym for Quality Assurance.

Quality control or assurance

Maintenance of standards in products or services through testing and procedures.

Quenching

Cooling of filaments after extrusion by carefully controlled airflow.

Rr

Random laying

Forming a web in such a way that the fibers or filaments are laid in essentially random directions. This is accomplished by using an air laid or wet laid process.

Random laid nonwoven

A random laid web bonded by one or more bonding techniques to provide fabric integrity.

Random laid web

A web in which the fibers are laid in essentially random directions.

Rated filter capacity

The specific quantity of fluid that a filter manufacturer recommends can be handled by the filter.

Rayon fiber

A manufactured fiber composed of regenerated cellulose, as well as manufactured fibers composed of regenerated cellulose in which the substitutes have replaced not more than 15% of the hydrogen atoms of the hydroxyl group (FTC definition). Rayon is manufactured from the cellulose found in vegetable matter, the major source being wood pulp and cotton linters. The cellulose is dissolved into a viscose solution and then extruded through a wet-spinning system to coagulate the filaments. The principal physical properties of rayon is moderate strength, softness, luster, hydrophilic and ease of dyeing. The major nonwoven market is wipes.

Reconstituted fibers

Fibers made from recovered waste polymer or blends of virgin and recovered waste polymer.

Relaxation

The decay or relaxation of stress exhibited by a material when held at constant strain.

Repellency

The ability to resist wetting and staining by materials and soils.

Resilience

The area under the stress-strain curve from the origin to the yield point.

Resiliency

Ability of a fiber or fabric to spring back when crushed or wrinkled.

Resin

Any of a group of solid or semi-solid materials made by chemical synthesis. The materials are often used in plastics or production of synthetic fibers (see **Polymer**).

Resin bonding

A common method of web bonding by using chemical agents, which may include adhesive resins and solvents. Most common is resin bonding. Latex resins (adhesive) are applied to the web by a variety of methods: dipping the web into the latex and removing the excess, spraying, foaming or printing bonding. The resin is usually in a water-based solution, so this bonding process requires heat to remove the water to dry and set the binder into the fabric. This is sometimes referred to as “latex bonding.”

Reworked fibers

Fibers that are sourced from several areas and recycled into needlepunched materials often destined for padding or insulation. This material is often referred to as “shoddy.”

Roll goods

Fabric rolled up on a core after it has been produced. It is described in terms of fabric weight and the width and length of the material on the roll.

Ss

Saturation bonding

A web bonding technique that saturates a web with an adhesive binder followed by drying and curing.

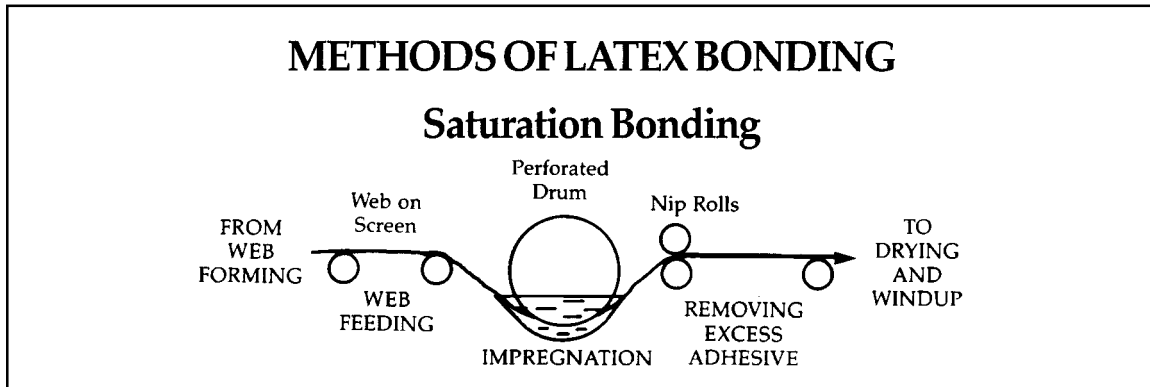

Screen printing or bonding

In the context of nonwovens, this usually refers to a method of resin bonding a web of fibers. A cylindrical screen containing a latex resin binder is rolled and pressed against a moving web of fibers. As the cylinder rotates against the web, adhesive binder is squeezed into the web. The binder is then dried by heat thereby bonding the web. See **Resin Bonding** for further information. An advantage of screen bonding (sometimes referred to as latex printing) is that the amount of binder squeezed onto the web can be controlled by the pattern and hole sizes in the screen. Color pigments can be added to the binder and this bonding method is often used to print end products, such as colored wipes.

Scrim

A textile with an open structure, which may be woven or nonwoven, added to reinforce weaker materials.

Scroop

The term refers to the characteristic crunch when loose, bleached cotton is hand squeezed. The sound is described as the crunch of walking on fresh fallen snow.

Seam strength

The ability of a fabric to hold a seam against tension.

Seaming

Joining the overlap of two pieces of fabric, usually near their edges.

Secondary backing

A layer of material laminated to the underside of a carpet to lock in carpet tufts, improve abrasion resistance, dimensional stability and strength.

Seconds

Imperfect roll goods that have various flaws, such as weight lower or higher than specified, poor bonding, inconsistent web formation, poor tensile strength and many more.

Short fiber

Staple fiber less than 0.5 inches long. Typically used in wet laid processes, to make fabrics, or as fillers in the absorbent cores of disposable diapers.

Short-life nonwoven

Synonymous with Disposable nonwoven.

Shrinkage

A reduction in length or width due to the effect of heat, moisture or chemical action.

Sintering

The process of adding a dry adhesive to a web and heating the web to the point that the adhesive melts and flows to bind the web once cooled. The sintering process is commonly done as a finish to apparel interlining. The adhesives are added to the nonwoven surface in a discrete pattern. The sintered interlining will adhere to the apparel fabric when reheated.

Sisal

A tropical plant by the same name with fibrous leaves that are used to make rope and other miscellaneous products.

Smog

A mixture of gases and aerosols generated from a variety of sources, such as automobiles' exhaust, burning coal for electricity generation and discharges from many industrial processes. Smog can contain noxious substances and acids that have a damaging effect to the environment and respiratory organs.

Smoke

An aerosol of particles usually solid formed from combustion of organic materials, such as wood, coal, oil, etc. It usually refers to the soot or carbon particles less than 0.1 mm, which results from incomplete combustion.

Smouldering

A slow, flameless, smoking burning of a fabric.

Solution-dyeing

Adding pigments or insoluble dyes into the polymer melt or spinning solution prior to extruding a manmade fiber.

Solution spinning

See **Dry Spinning**.

Sorbent

A nonwoven fabric used to attract and/or contain fluids. The term is most commonly used to describe products that are used to clean-up environmental oil spills and around machinery in a workplace to capture oil and other fluids. Oleophilic fibers, such as from polypropylene, are widely used in these products.

Specific gravity

Ratio of the mass of a material to the mass of an equal volume of water at 4°C.

Spin finish

A lubricant applied to fibers to reduce friction and static during processing into yarns and fabrics.

Spinning

A process by which filaments or fabrics, made from filaments, are generated directly by passing a molten polymer through a spinneret.

Spinneret

A disc or plate containing many small holes through which molten polymer is extruded to form filaments. Spinnerets are used in the spunlaid process or production of filaments. Occasionally the spelling is “spinnerette.”

Spray bonding, Spray bonded

A method of binding fibers to form a fabric. The adhesive binder is sprayed onto the web of fibers and subsequently dried and cured. See **Resin Bonding**.

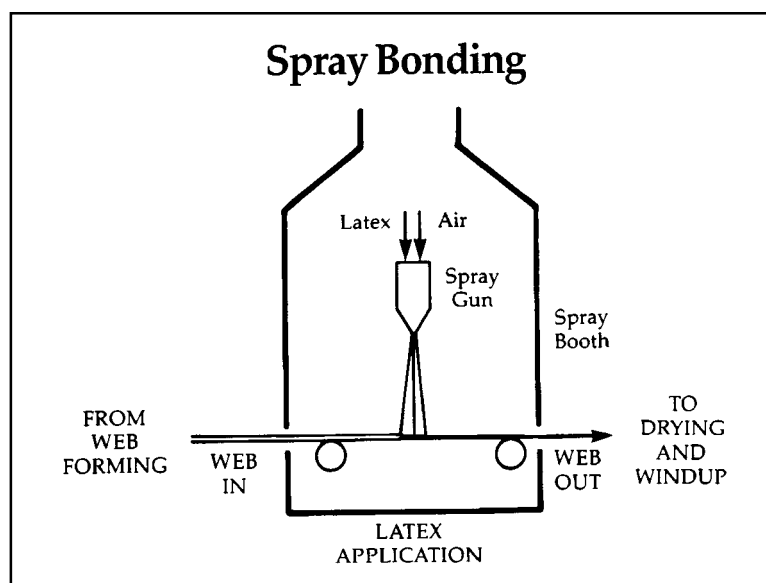

Spreading

Generally refers to the method of increasing a web's width, wider than the card's width, prior to bonding and altering fiber orientation in nonwoven fabric production.

Spunbond, Spunbonded

A spunlaid technology in which the filaments have been extruded, drawn and laid on a moving screen to form a web. The term is often interchanged with "spunlaid," but the industry had conventionally adopted the spunbond or spunbonded term to denote a specific web forming process. This is to differentiate this web forming process from the other two forms of the spunlaid web forming, which are melt blown and flashspinning.

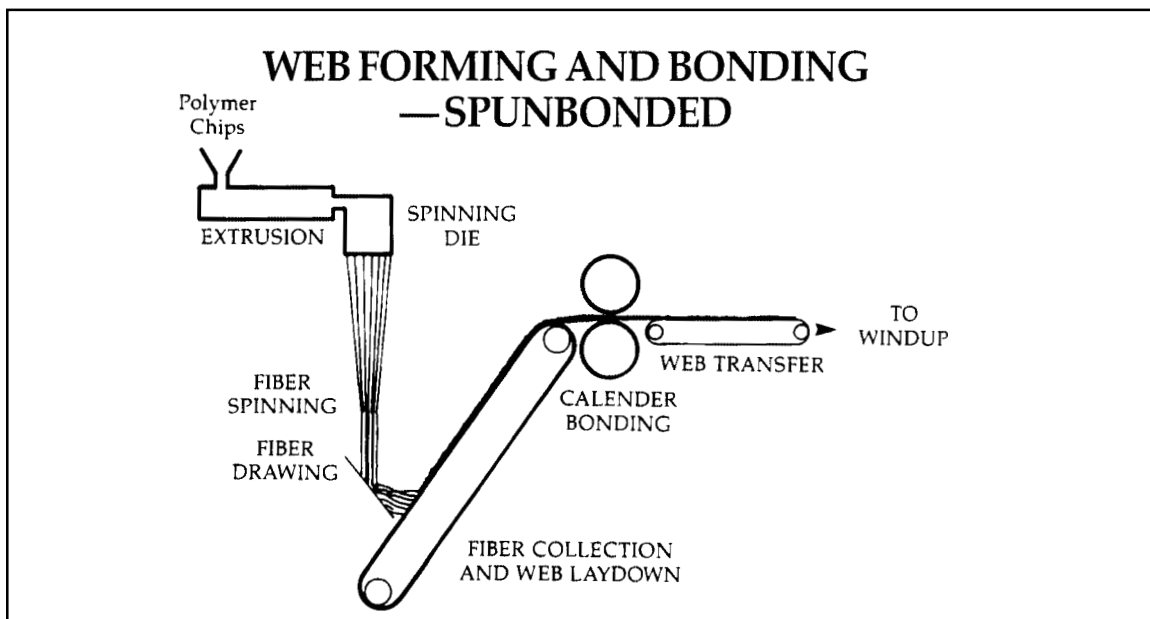

Spunbond nonwoven, Spunbonded nonwoven

A fabric formed from spunbonded process that has been bonded by one or more methods to provide fabric integrity.

Spunbond/Melt blown composite

A multiple layer fabric that is generally made of various alternating layers of spunbond and melt blown webs: SMS, SMMS, SSMMS, etc.

Spunlace bonding, Spunlaced bonding

The method of bonding a web by interlocking and entangling the fibers about each other with high velocity streams of water (synonymous with Hydroentangling). The web or fabric may have other bonding methods in addition to spunlacing. Spunlacing, not to be confused with spunlaid, is generally produced from a web made up of staple fibers from a dry formed, carded system, but small quantities of spunlace bonding are done on production lines that use a wet laid forming process. A recent technical development is the production of a spunlaced nonwoven from a spunlaid, continuous filament web.

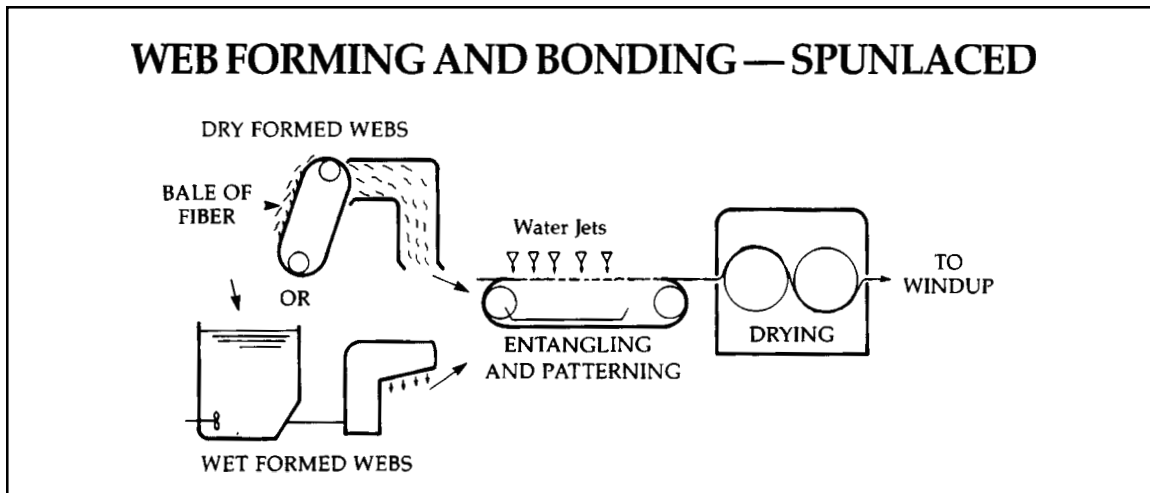

Spunlace nonwoven, Spunlaced nonwoven

A fabric produced by the spunlace technology. Spunlace is synonymous with hydroentangling.

Spunlaid

A method of forming a web in which a polymeric melt or solution is extruded through spinnerets to form filaments which are laid down on a moving screen. Melt spun forming processes include spunbond, flash spinning and melt blown. The most common polymers used are polypropylene, polyester and polyethylene.

Staple fiber

Refers to natural or synthetic cut fibers. The word “staple” is used by the textile industry to differentiate cut fibers from continuous filament fibers, such as that used in the spunlaid process. Synthetic staple fibers used in the needlepunched process are generally about 3.8-4.8 cm in length. The fiber lengths of natural fibers, which include wool, cotton, choir, jute and several others, vary considerably.

Start-up

The time when a new production line is finally put into commercial production after the production line is commissioned. This term is synonymous with “on-stream.”

Static

An accumulation of electrical charge on the surface of fibers or fabrics due to its inadequate dissipation during processing or use.

Statistic

A quantity that is calculated from observations on a sample and that estimates a parameter of a population.

Sterilizing filter

A filter that uses a media of sufficient fineness to remove bacteria. These are usually membrane or depth filters.

Stiffness

The ability of a fabric to resist bending. It is related to fiber modulus or elasticity.

Stitch bond, Stitch bonded

A technique in which fibers in a web are bonded together by stitches sewn or knitted through the web to form a fabric. The finished fabric usually resembles corduroy.

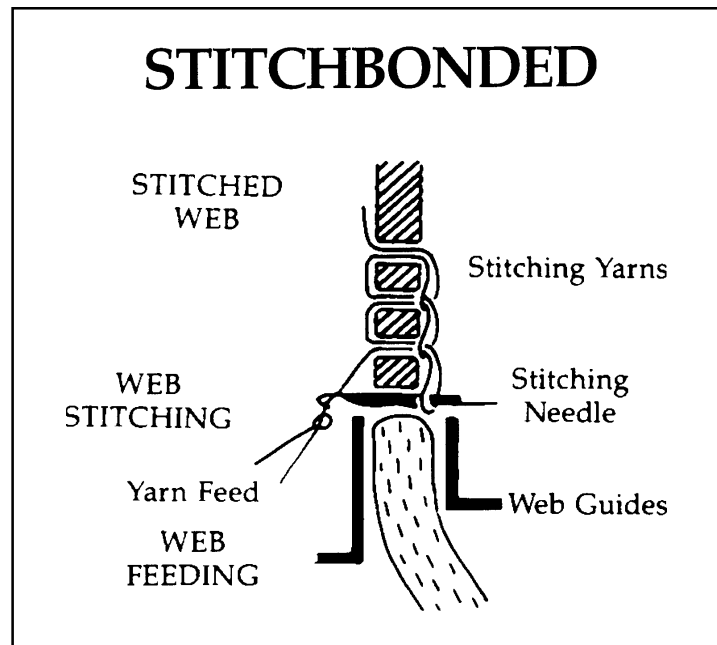

Stitch bond nonwoven

A nonwoven produced by the stitch bonding process.

Stress-strain curve

Graph showing the amount of stretch or compression obtained as a function of the force applied and the point at which rupture or breakage occurs.

Stretch

The ability of a fabric to grow in length when pulled.

Substrate

Fabric to which coatings or other fabrics are applied.

Superabsorbent (SAP)

A sorbent material that can absorb many times the amount of liquid ordinarily absorbed by cellulosic materials, such as wood pulp, cotton and rayon.

Surface charge

Electrical charge on a fiber or fabric.

Surface energy

The work necessary to increase the surface area of a liquid – generally expressed in dynes per square centimeter. Dynes are units of work.

Surface filter

A thin filter material that retains contaminants on the surface.

Surface tension

Forces acting between the molecules making up the surface of a liquid, causing the surface to contract to a minimum. Since it is a measure of the attraction of a liquid for itself, it can be related to its ability to mix with other liquids or to wet other surfaces.

Surfactant

A chemical additive that changes the surface attraction between two liquids, or between a liquid and a solid, by changing the surface energy of one or both components.

Swelling

Expansion of a fiber caused by exposure to a solvent or chemical agent.

Synthetic fiber

A man-made fiber, usually from a molten polymer or from a polymer in solution.

Tt

Tackifier

A viscous substance; usually oil, pressure sensitive resins or solvents, which are applied to the surface or throughout a filter media to increase the retention of dust.

Tear strength

Resistance of a material to being torn.

Technical textile

A general term used to describe a broad range of textiles that are designed for specific applications. These textiles include nonwovens, wovens, knits and film composites. The types of end-products usually associated with technical textiles are nonwovens and certain woven, knitted and film fabrics used in products, such as protective apparel (hazardous waste, fire, clean room, military, etc.), parachutes, “hi-tech” tenting materials, flags, automotive interior fabrics and housewrap - to name a few.

Tenacity

A measure of the strength of a fiber. The force exerted per unit linear density when tensile stress is applied. Expressed as grams of force per denier or newtons per tex. Newtons are units of force.

Tenacity

The specific stress at the breaking point.

Tensile strength

The strength of a material when subjected to either pulling or to compressive stress. It measures the stress a material can bear without breaking or tearing.

Test method

A procedure for the identification, measurement, and evaluation of one or more qualities of a material, product, system or service that produces a test result.

Tex

A metric measure of the weight per unit of a fiber. It is numerically equal to the weight in grams of one kilometer (1000 meters) of the material. It is also equal to the denier divided by 9 (see **Denier**).

Texturing

A process for imparting crimp, crepe and bulk to fibers, yarns and fabrics.

TFPIA

Textile Fiber Products Identification Act (approved by the U.S. Congress in 1958 and most recently amended in 1998). This legislation was intended to protect producers and consumers against misbranding and false advertising of the fiber content in textile fiber products. In addition to establishing generic names and definitions for manufactured fibers, the Act also sets forth labeling regulations and tolerances for fiber content.

Thermal bonded/Thermobonded

A web of fibers bonded by a thermal bonding (thermobonding) process.

Thermal bonding/Thermobonding

A technique for bonding a web of fibers in which a heat or ultrasonic treatment, with or without pressure, is used to activate a heat-sensitive material. The material may be in the form of homofil fibres, bicomponent fibers, fusible powders, as part of the web. The bonding may be applied all over (e.g. through or area bonding) or restricted to predetermined, discrete sites (e.g. point bonding).

Thermoplastic

A plastic that melts when heated.

Thermoset

A plastic, once formed, that does not melt when reheated.

Thickness

The dimension of a sheet or lamina measured perpendicular to the plane of the sheet.

Through-air bonding

A bonding system that uses high temperature air to fuse the web's fibers. There are two basic systems: blowing hot air through the web in a conveyor oven or passing heated air through the web on a rotating drum (illustrated below). Fabrics made from bicomponent fibers or blends of bicomponent and regular fiber are often bonded by through-air bonding systems. This method is sometimes referred to as air-through bonding.

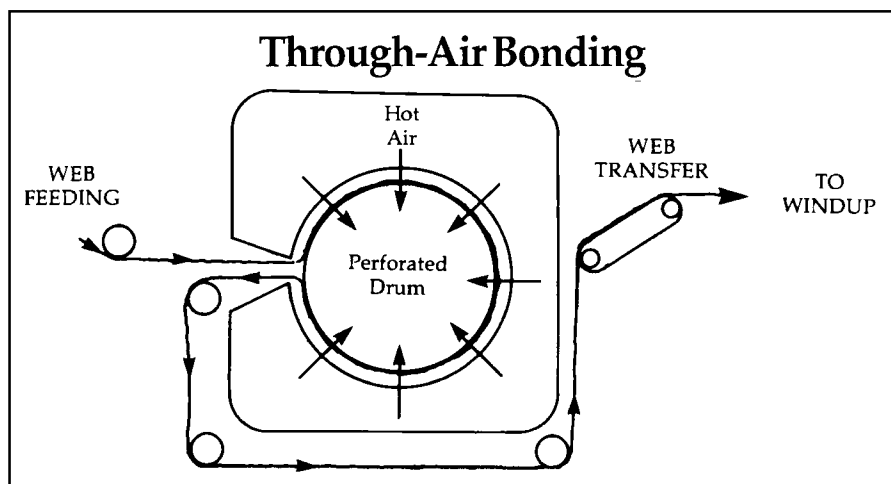

Throughput

Amount of output or production per unit time.

Ticking

Strong fabric used as a covering for a mattress or pillow and in upholstery.

Titanium dioxide

A natural chemical compound (TiO₂) often used to pigment polymers in the spinning process to add whiteness.

Tolerance

The permitted variation in the measurement of specified property, such as weight, strength, color, etc., that is being observed in a test method.

Top sheet

The cover stock that is the first layer inside the diaper that touches the body. The material is permeable allowing body fluids to pass through to the diaper's core leaving a dry surface in contact with the wearer's skin.

Torsional rigidity

The resistance of a fiber to twisting, defined as the couple required to twist a fiber of unit length to unit angular deflection or the torque required to cause unit twist.

Toughness

The energy-absorbing capacity of a fiber, defined as the specific work of rupture and obtained by measuring the area under the stress-strain curve.

Tow

A bundle of continuous filaments – the form of most man-made filaments before being cut into staple.

Transition temperature

A temperature at which some radical change, usually a phase change, in the appearance or structure of a substance occurs.

Tricomponent fiber

A fiber that is made from three polymers that are physically or chemically different.

Tufted carpeting

A pile carpeting produced by a tufted process. In the process, fibers are carried by a series of needles and thrust through the carpet backing to be held in place by the backing as the needles are withdrawn. Nonwoven materials are used as primary and secondary carpet backing for some applications, often in automotive and modular carpeting.

Uu

ULPA

The acronym for Ultra Low Penetration Air (filter). Air filters made to ULPA standards have filtration efficiencies of 99.999% on 0.3 micron DOP particles.

Ultrasonic bonding

The use of high frequency sound to generate localized heat through vibration and cause thermoplastic fibers to bond to one another.

Ultraviolet absorbers

Various chemicals or polymers added to the product that absorb the ultraviolet light or otherwise make the material resistant to ultraviolet degradation.

Ultraviolet resistance

The ability to retain strength or other properties upon exposure to ultraviolet light.

Ultraviolet stability

Degree of a material's resistance to degradation by ultraviolet rays.

Ultraviolet degradable

The ability of a substance to be broken down by the action of the ultraviolet part of the light spectrum.

Unbonded

A fiberfill material that has not had any form of bonding treatment.

Underlay

A layer of material, such as foam, felt or rubber padding, placed under carpeting or rugs to provide cushioning and increase service use.

Unidirectional fabric

A fabric having strength mostly in one direction, generally the machine direction.

U.V.

Ultraviolet rays

Unwind:

The name often given to the equipment from which a roll of fabric is unwound for further processing or converting. It is also referred to as the unwinder or unwind stand.

V v

Van der Waals forces

The forces of attraction and repulsion between molecules caused by the electric fields of the electrons (negative) and the nuclei (positive). The forces of molecular attraction explain why particles adhere to a filter's fiber.

Vapors

A substance in the gaseous state which is usually in a liquid or solid state.

Virus

A semi-living, generally inert microscopic particle chiefly protein in composition. They replicate by entering a living cell and direct the cell to reproduce more viruses. The cell is usually destroyed as the new viruses are released to the surrounding environment.

Viscose fiber

See **Rayon Fiber**.

W w

Warp

The yarns that run in the machine direction of a woven fabric.

Warp knitting

See **Knitting**.

Wash and wear properties

Ability of a fabric to retain its strength and appearance after repeated washings and dryings.

Water repellency

The ability to resist wetting by water.

Weak web

A term generally used in the context of web formation in a carding process. It refers to the low cohesion of the fibers to one another and thus the web does not have the strength to transfer from one working component to another in the carding process. This situation can be caused by a number of factors, such as poor fiber finish or humidity problems.

Wear test

A test that evaluates a fabric's properties in actual use through laundering, cleaning and other wearing conditions.

Web

A sheet made by laying down and assembling fibers or by creating holes or cracks in a plastic film.

Web consolidation

See **Bonding**.

Weight

The mass of a fabric expressed in grams per square meter or ounces per square yard.

Wet laid definition

To distinguish nonwovens from papers, a wet laid material will be defined a nonwoven if:
More than 50%, by mass, of its fibrous content is made up of fibers (excluding chemically digested vegetable fibers) with a length to diameter ratio greater than 300:

or

More than 30%, by mass of its fibrous content is made of fibers in "a" above and meet one or both of the following criteria:

Length to diameter ratio of more than 600.

The density of the fabric is less than 0.4 g/cc.

Wet laying or Wet forming

Wet laid nonwovens are produced in a process similar to paper making. The nonwoven web is produced by filtering an aqueous suspension of fiber onto a screen conveyor belt or perforated drum. Many wet laid nonwovens are made with wood pulp or other natural fibers blended with synthetic fibers or fiberglass.

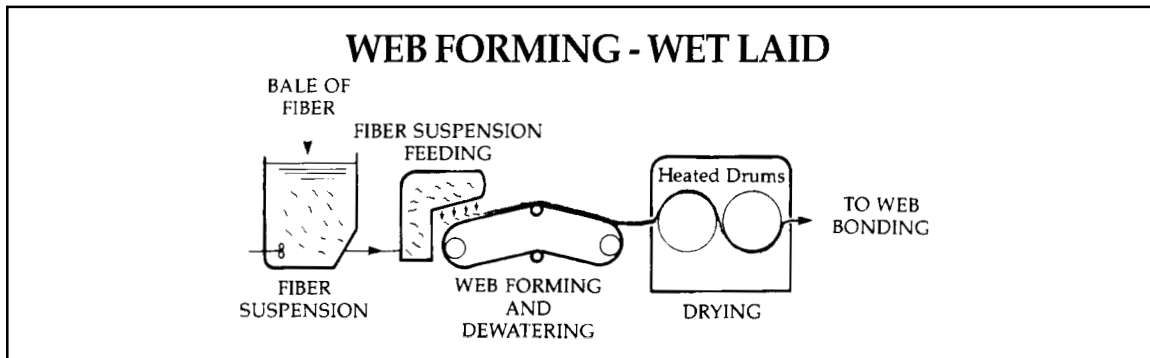

Wet laid nonwoven

A wet laid web bonded by one or more techniques to provide fabric integrity.

Wet laid web

A web of fibers produced by the wet laying process.

Wet spinning

The process of passing a fiber forming polymer through spinnerets and coagulating the polymer into fibers in a chemical bath.

Wet strength

The resistance of a fabric to being torn when it is wet. Usually compared to its strength when dry.

Wetting agent

Additive adsorbed to material surface that prevents water repellency and helps to spread liquid on the surface.

Wicking

Transport of liquid within an absorbent fabric, vertically into the fabric web and horizontally within the plane of the fabric.

Wood pulp

Cellulosic fibers used to make viscose rayon, paper and the absorbent cores of products such as diapers, sanitary napkins and adult incontinence pads.

Wrinkle

A small crease or fold in a fabric which is generally short in length and usually irregular.

Wrinkle resistance

The ability of a fabric to resist remaining creased, wet or dry, after it has been crushed and compressed.

Xx, Yy, Zz

Yarn

A continuous strand of fibers or filaments that are twisted together, to enable its conversion into a woven, knitted or braided fabric.

Yield

The number of square meters (square yards) produced by a kilogram (pound) of fiber or resin.

Yield point

The point at which a tangent to the stress-strain curve is parallel to a line joining the origin to the breaking point.

Zwitterionic surfactant

A chemical additive bearing both positive and negative charges that change the surface energy between two materials.