

TABLE OF CONTENTS



Knitwear - 111



Underwear - 133



Jeans - 143



Trousers - 161



Shirts - 169



Dresses - 185



Sportswear - 193



Home textiles - 205



Packing, leather and upholstery - 217



Hats - 225



Carpets - 229



Accessories - 231



UMA FITOPEK - 239



UMA REKA - 245

HOW TO USE CATALOG

Code number

UMA-02

Attachment name

Raw edge type blinder

Kind of work

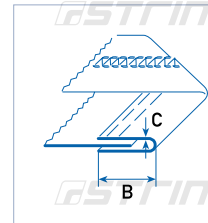

A	15	20	25	30	35	40	45	50	55
B	7.5	10	12.5	15	17.5	20	22.5	25	27.5
C	L	M	H						

Machine: Flat bed coverstitch machine

Thickness sizes

Attachment sizes

Suggested machine

Drawing

Light	L	up to 1,5 mm
Medium	M	up to 2,0 mm
Medium Heavy	MH	up to 2,2 mm
Heavy	H	up to 2,5 mm
Extra Heavy	XH	up to 3,0 mm

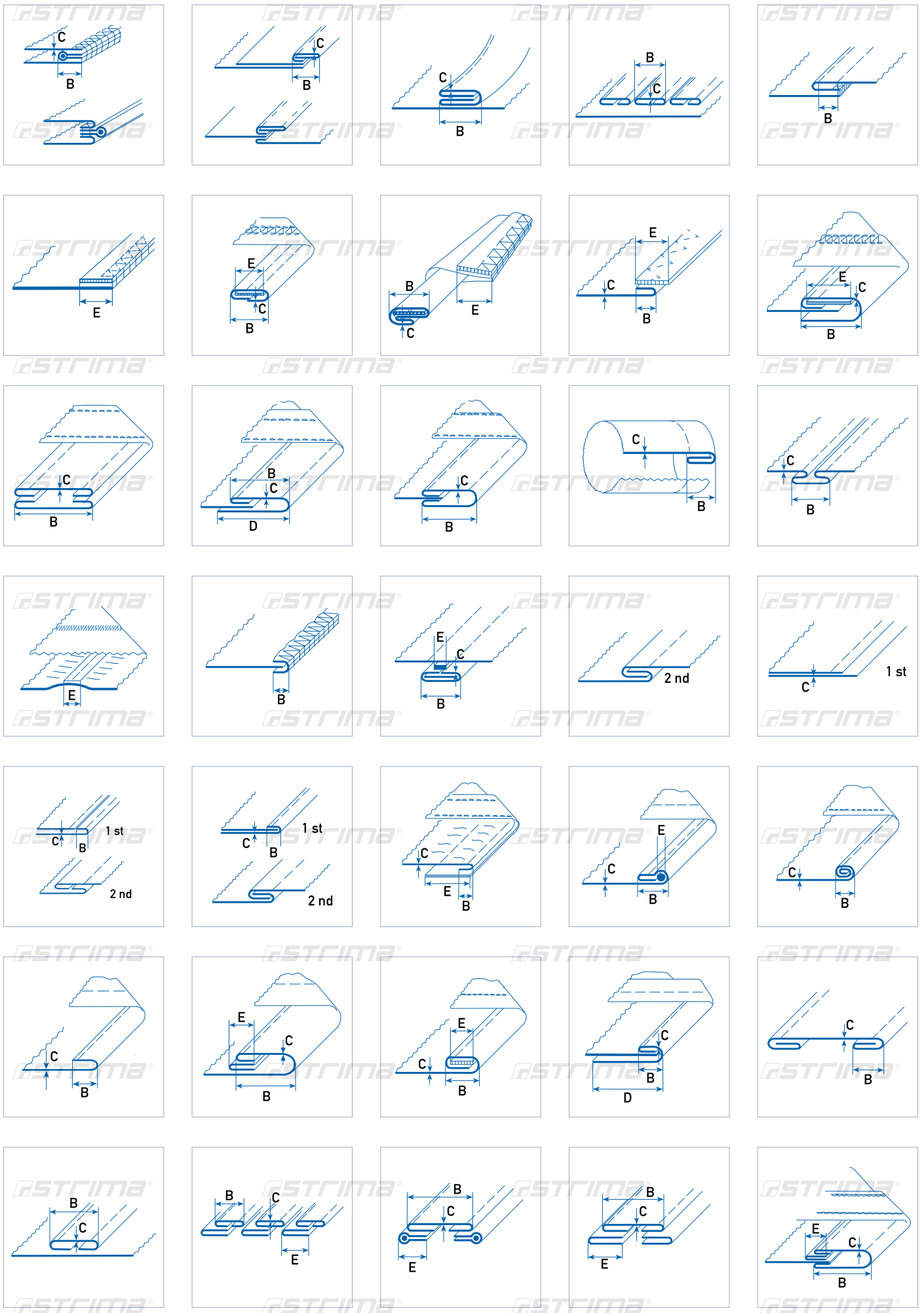

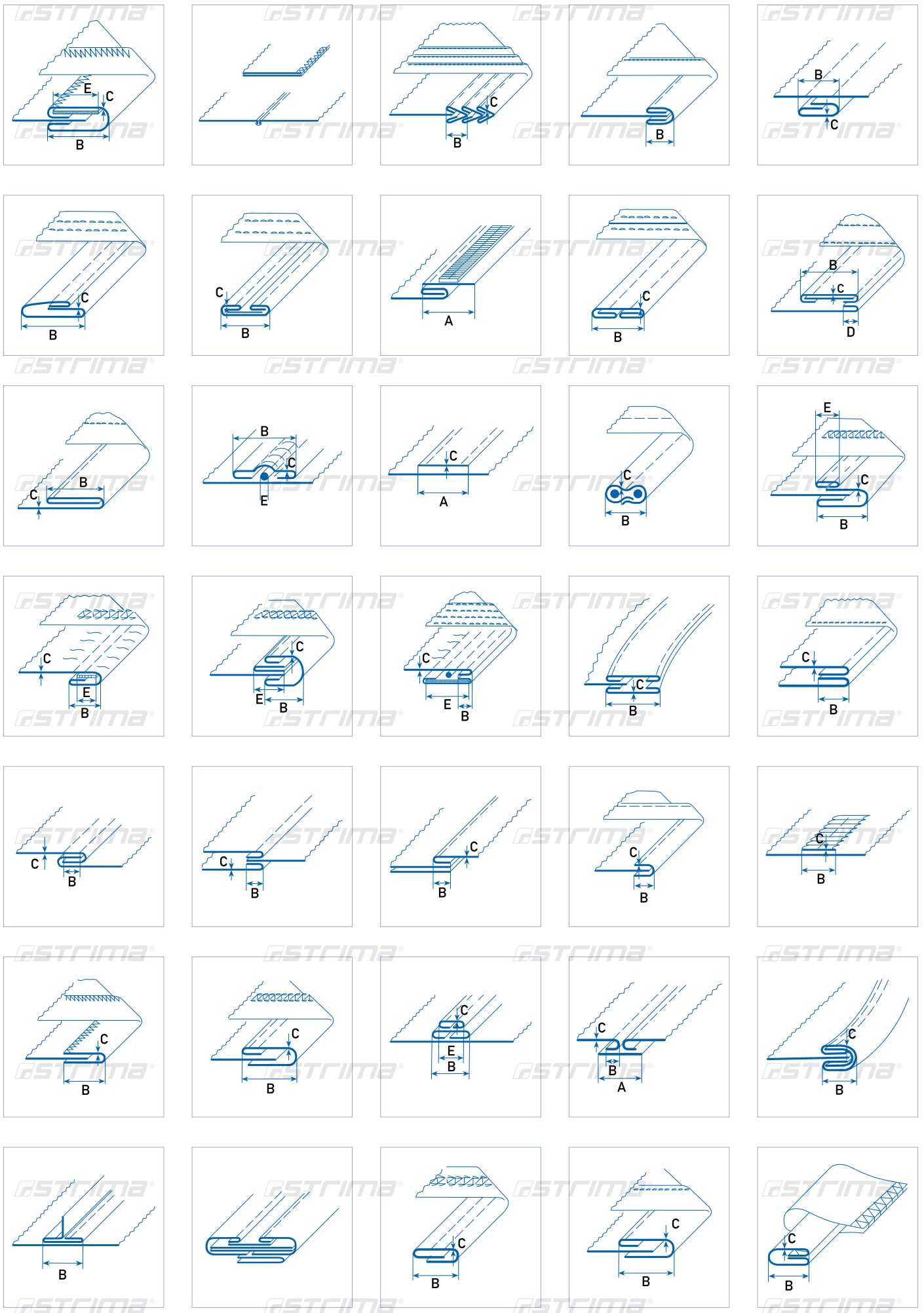

Introduction of knitwear attachments on product

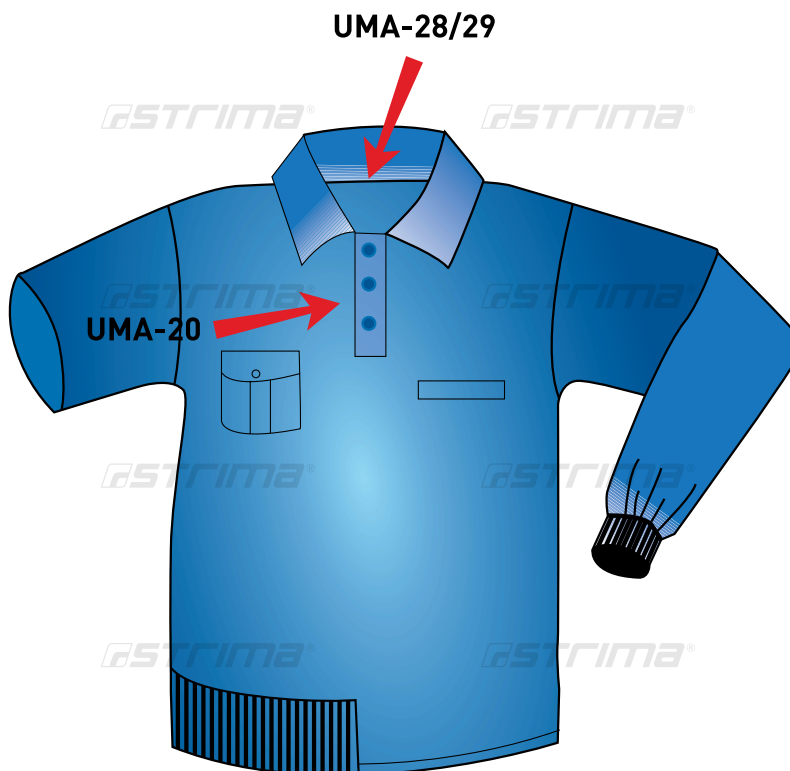
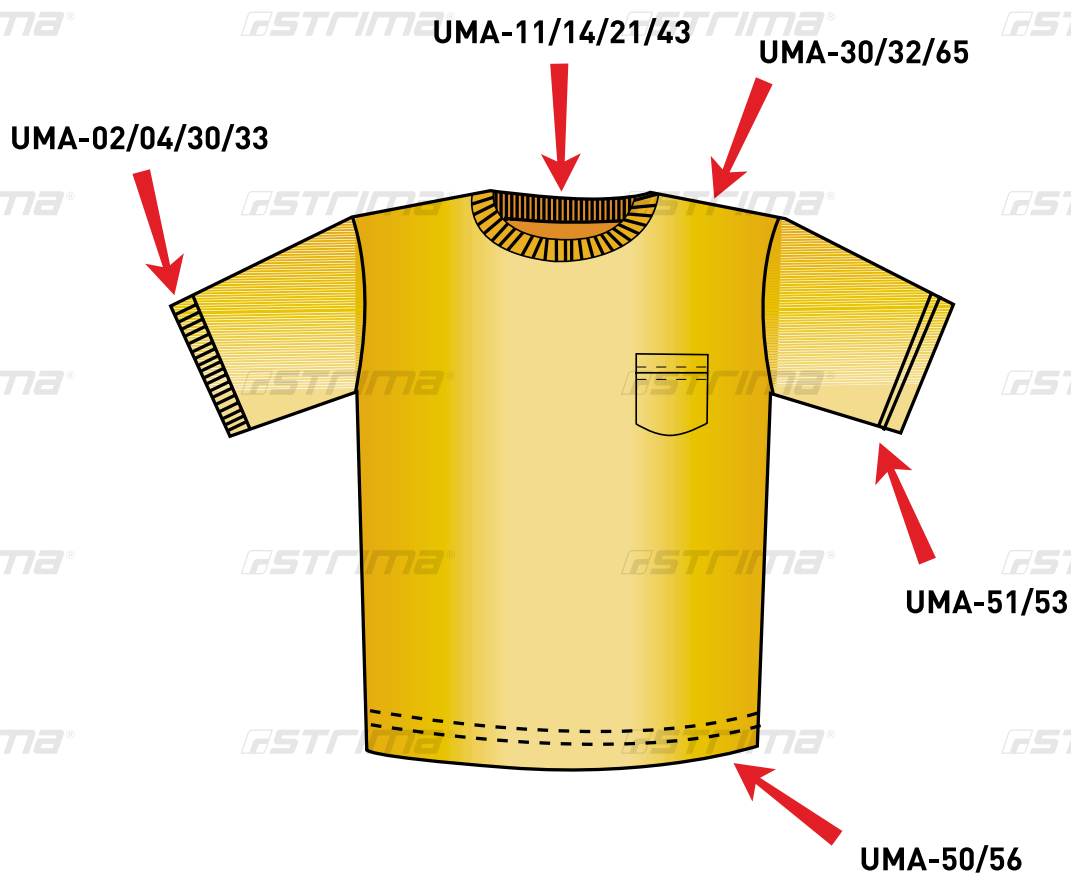

UMA-08

Collar split-tube folder single bottom fold

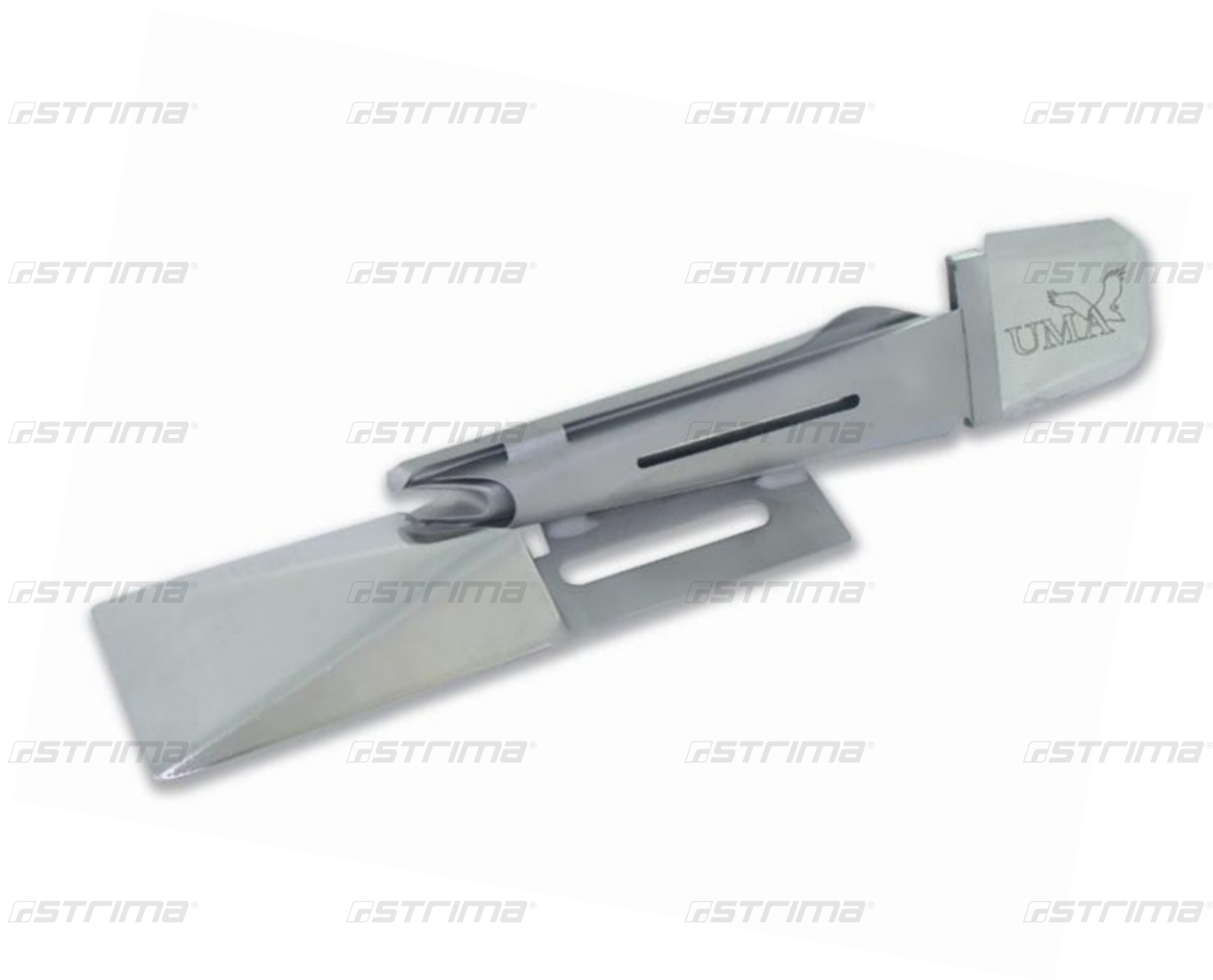

UMA-02

Raw edge tape binder

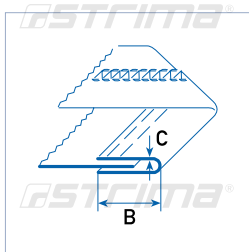

Machine: Flat bed coverstitch machine

A	15	20	25	30	35	40	45	50	55
B	7.5	10	12.5	15	17.5	20	22.5	25	27.5
C	L	M	H						

UMA-03

Collar raw edge tape binder

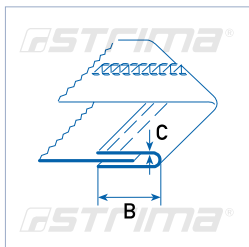

Machine: Flat bed coverstitch machine

A	15	20	25	30	35	40	45	50	55
B	7.5	10	12.5	15	17.5	20	22.5	25	27.5
C	L	M	H						

UMA-04

Raw edge tape binder set

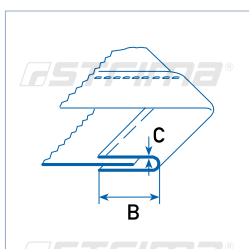

Machine: Standard lockstitch machine

A	12	15	18	20	25	30
B	6	7.5	9	10	12.5	15
C	L	M	H			

UMA-06

Split-tube folder single bottom fold

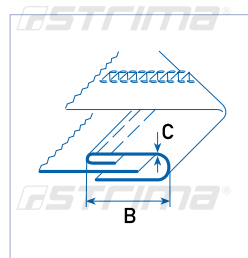

A 25 28 30 32 35 40 45 50 55 60 65 70 75 80 85 90 95 100

B 7 9 10 12 13 15 17 20 22 25 27 30 32 35 37 40 42 45

C L M H

Machine: Flat bed coverstitch machine

UMA-08

Collar split-tube folder single bottom fold

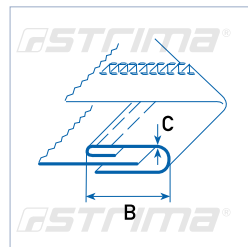

A 25 28 30 32 35 40 45 50 55 60

B 7 9 10 12 13 15 17 20 22 25

C L M H

Machine: Flat bed coverstitch machine

UMA-09

Right angle binder single bottom fold set

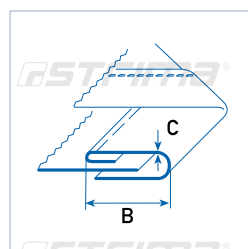

A 25 28 30 32 35

B 7 9 10 12 13

C L M H

Machine: Standard lockstitch machine

UMA-10

Split-tube folder double bottom fold

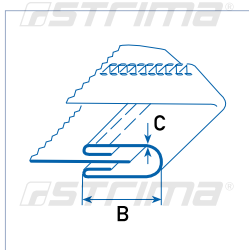

Machine: Flat bed coverstitch machine

A	22	25	28	30	32	35	40	45	50	55	60	65	70
B	5.5	6	7	8	9	10	12	13	15	17	20	22	25
C	L	M	H										

UMA-11

Split-tube folder double bottom fold

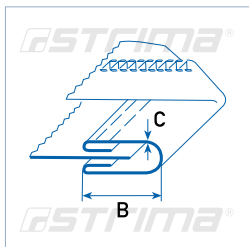

Machine: Flat bed coverstitch machine

A	25	28	30	32	35	40	45	50	55	60	65	70	75	80	85	90	95	100
B	6	7	8	9	10	12	13	15	17	20	22	25	27	30	32	35	38	40
C	L	M	H															

UMA-12

Split-tube folder double bottom sateen

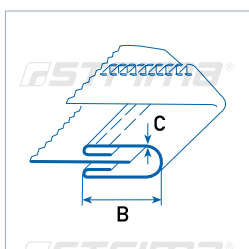

Machine: Flat bed coverstitch machine

A	25	28	30	32	35	40	45	50
B	6	7	8	9	10	12	13	15
C	L	M						

UMA-13

Collar split-tube folder double bottom fold

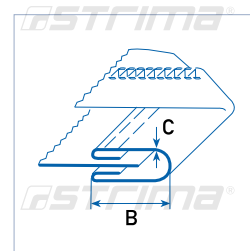

A 25 28 30 32 35 40 45 50 55 60

B 6 7 8 9 10 12 13 15 17 20

C L M H

Machine: Flat bed coverstitch machine

UMA-14

Right angle binder double bottom fold set

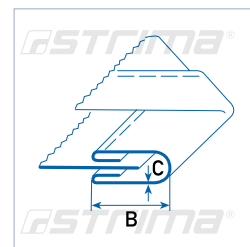
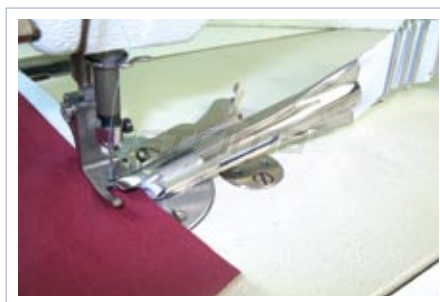

A 22 25 28 30 32 35 40 45

B 5 6 7 8 9 10 12 13

C L M H

Machine: Standard lockstitch machine

UMA-15

Adjustable raw edge tape binder

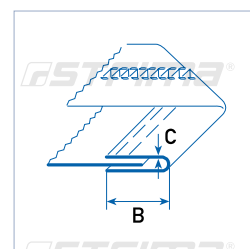
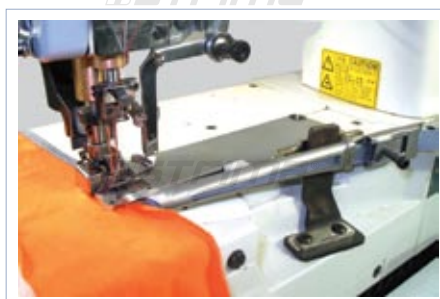

A 12 15 20 25 30 35 40

B 6 7.5 10 12.5 15 17.5 20

C L M H

Machine: Flat bed coverstitch machine

UMA-16 Adjustable split-tube folder single bottom fold

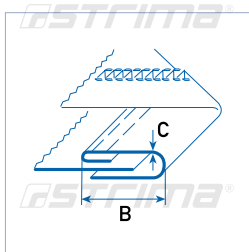
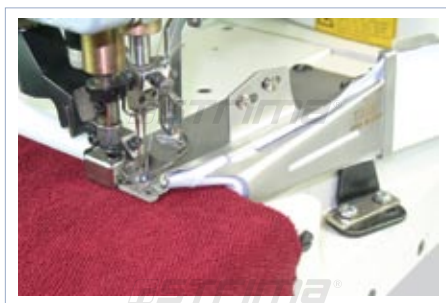

STRIMA

STRIMA

Machine: Flat bed coverstitch machine

A	25	28	30	32	35	40	45	50	55	60
---	----	----	----	----	----	----	----	----	----	----

B	7	9	10	12	13	15	17	20	22	25
---	---	---	----	----	----	----	----	----	----	----

C	L	M	H
---	---	---	---

UMA-17 Adjustable split-tube folder double bottom fold

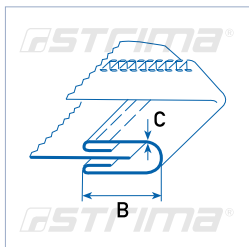

STRIMA

STRIMA

Machine: Flat bed coverstitch machine

A	25	28	30	32	35	40	45	50	55	60
---	----	----	----	----	----	----	----	----	----	----

B	6	7	8	9	10	12	13	15	17	20
---	---	---	---	---	----	----	----	----	----	----

C	L	M	H
---	---	---	---

UMA-20 Attachment to make button stay on polo shirt (with air)

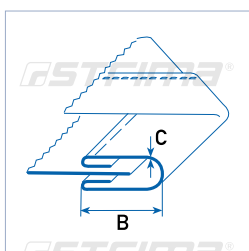

Machine: Walking foot lockstitch machine

A	60	70	80	90	100
---	----	----	----	----	-----

B	20	25	30	35	40
---	----	----	----	----	----

C	L	M	H
---	---	---	---

UMA-20-B

Attachment to make button stay on polo shirt



A 60 70 80 90 100 106

B 20 25 30 35 40 42

C L M H

Machine: Standard lockstitch machine

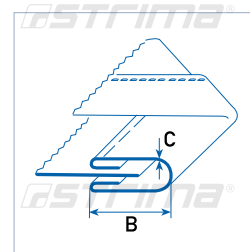

UMA-21

Collar tape folder



A 40 45 50 60 70 80

B 20 22,5 25 30 35 40

C L M H

Machine: Flat bed coverstitch machine

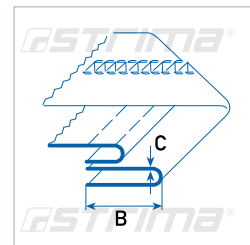

UMA-22

Collar and cuff ribbed folder



UMA-22-BR
UMA-22-JU
UMA-22-SI
UMA-22-KG
UMA-22-PG

A 40 45 50 60 70 80 90 100

B 20 22,5 25 30 35 40 45 50

C L M H

Machine: Overlock machine

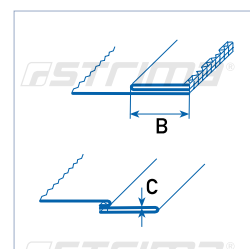

UMA-23

Multi tape attach folder

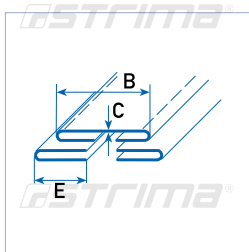
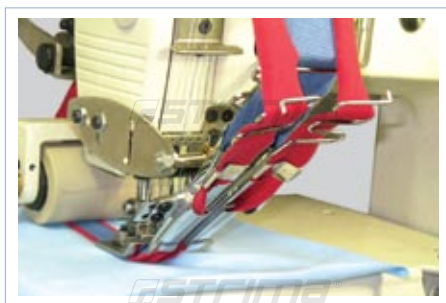

A	30	35	40	D	15	20	25
B	15	17.5	20	E	7.5	10	12.5
C	L	M	H				

Machine: 6-12 needle chainstitch flat-bed machine

UMA-25

Tape folder

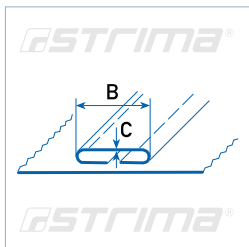

A	15	18	20	22	25	28	30	40	50
B	7.5	9	10	11	12.5	14	15	20	25
C	L	M	H						

Machine: Flat bed coverstitch and 2 needle machines

UMA-27

Lay-on folder with foot

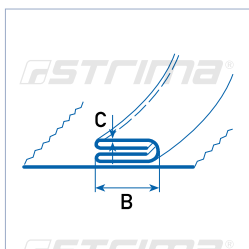
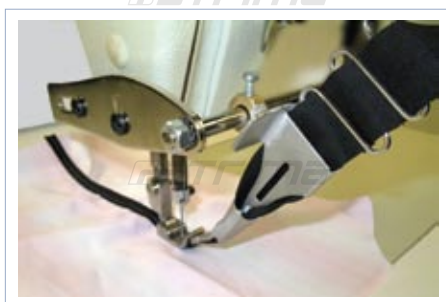

A	20	25	30
B	5	7	8
C	L	M	

Machine: Standard lockstitch and 2 needle machines

UMA-28

Attachment to sew the neckline on polo shirt-set

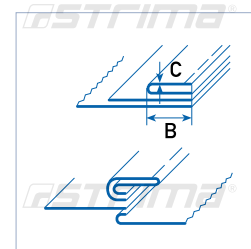

A 20 25

B 10 12.5

C L M

Machine: Standard lockstitch machine

UMA-29

Attachment & foot to sew the neckline on polo shirt-set

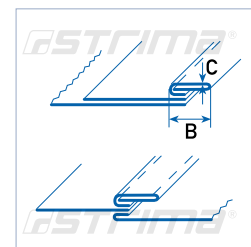

A 22 28

B 9 12

C L M

Machine: Standard lockstitch machine

UMA-30

Piping attachment

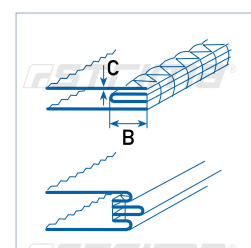

UMA-30-BR
UMA-30-JU
UMA-30-SI
UMA-30-KG
UMA-30-PG

A 20 25 30 35 40 50

B 10 12.5 15 17.5 20 25

C L M H

Machine: Overlock machine

UMA-32

Adjustable ready - made cord edge piping attachment

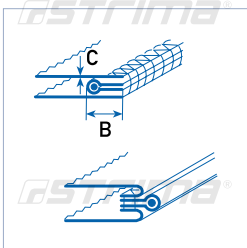

UMA-32-BR
 UMA-32-JU
 UMA-32-SI
 UMA-32-KG
 UMA-32-PG

A	20	25	30	35	40
B	10	12.5	15	17.5	20
C	L	M	H		

Machine: Overlock machine

UMA-33

Adjustable ready - made cord edge piping attachment

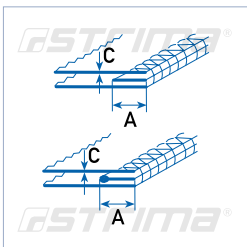

UMA-33-BR
 UMA-33-JU
 UMA-33-SI
 UMA-33-KG
 UMA-33-PG

A	6	8	10	12	15
C	L	M			

Machine: Overlock machine

UMA-34

Double piping attachment

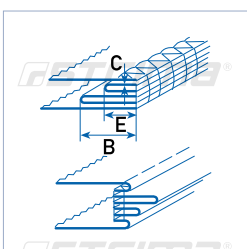

UMA-34-BR
 UMA-34-JU
 UMA-34-SI
 UMA-34-KG
 UMA-34-PG

A	20	25	30	35	40	D	20	25	30	35	40
B	10	12.5	15	17.5	20	E	10	12.5	15	17.5	20
C	L	M									

Machine: Overlock machine

UMA-35

Attachment to sew the neckline on polo shirt

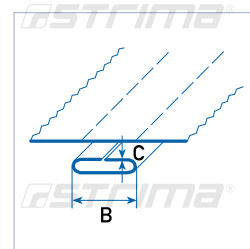
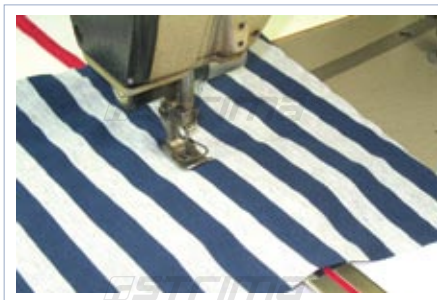

A 25

B 10

C L M

Machine: 2 needle coverstitch machine

UMA-37

Split tube folder single with tape

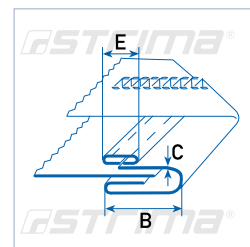

A 30 35 40

D 15 20

B 10 13 15

E 7.5 10

C L M

Machine: Flat bed coverstitch machine

UMA-38

Split tube folder with tape

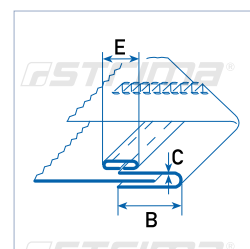

A 25 30 40

D 15 20

B 12.5 15 20

E 7.5 10

C L M

Machine: Flat bed coverstitch machine

UMA-39

Collar split tube folder with tape

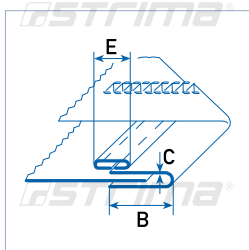

Machine: Flat bed coverstitch machine

A	25	30	40	D	15	20
B	12.5	15	20	E	7.5	10
C	L	M	H			

UMA-41

Split tube folder (single bottom) with piping folder

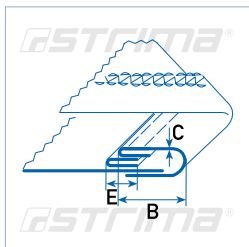

Machine: Flat bed coverstitch machine

A	25	28	30	32	35	40	50	60	D	20	25
B	7	9	10	12	13	15	20	25	E	10	12.5
C	L	M	H								

UMA-43

Split tube folder (double bottom) with piping folder

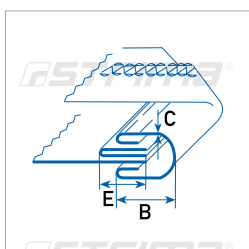

Machine: Flat bed coverstitch machine

A	28	30	32	35	40	45	50	60	D	20	25
B	7	8	9	10	12	13	15	20	E	10	12.5
C	L	M	H								

UMA-44

Split tube folder (double bottom) with piping folder



A	28	30	32	35	40	D	15	20	25
B	7	8	9	10	12	E	7.5	10	12.5
C	L	M	H						

Machine: Standard lockstitch machine

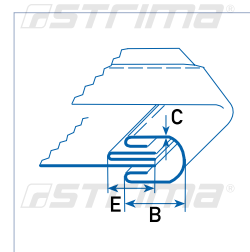

UMA-47

Folder laying ornamental strippings



A	20	25	30	40
B	10	12.5	15	20
C	L	M	H	

Machine: Flat bed coverstitch machine

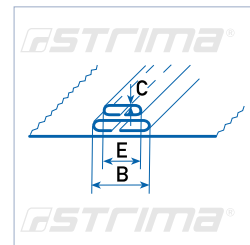

UMA-50

Single downturn feller



B	10	15	20	25
C	L	M		

Machine: Flat bed coverstitch machine

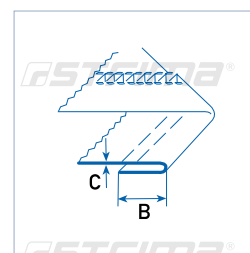

UMA-51

Adjustable hemmer for knitted fabric

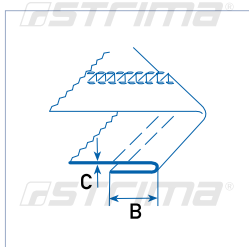
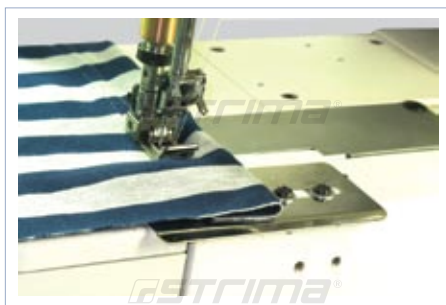

Machine: Flat bed coverstitch machine

B 10 ~ 35 mm

UMA-53

Adjustable guides for tubular operation

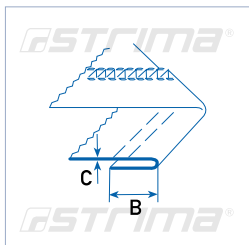

Machine: Flat bed coverstitch machine



UMA-54

Hemmer for knitted fabric

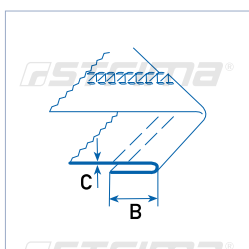

Machine: Standard lockstitch or flat bed coverstitch machine

B 10 15 20 25

C L M H

UMA-55

Hemmer for knitted fabric

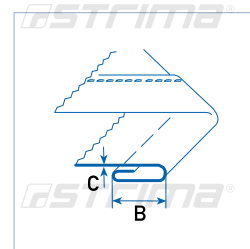

B 10 15 20

C L M H

Machine: Standard lockstitch or flat bed coverstitch machine

UMA-56

Adjustable hemmer for knitted fabric

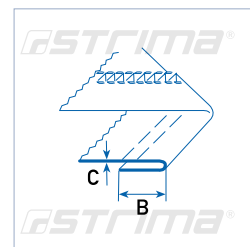

B 10 ~ 35 mm

Machine: Flat bed coverstitch machine

UMA-60

Joining guide

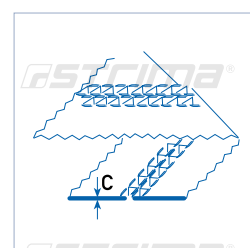
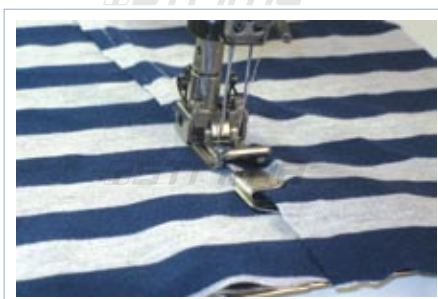

C L M H

Machine: Flat bed coverstitch machine

UMA-61

Adjustable elastic shirring foot

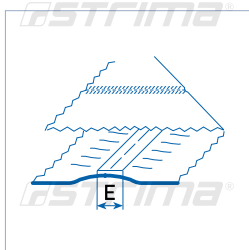

Machine: Standard lockstitch or flat bed coverstitch machine



61 R

E	5	6.5	8	10
----------	---	-----	---	----

UMA-62

3 split overlock folder

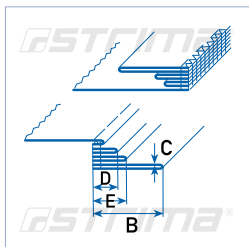

Machine: Overlock machine

- UMA-62-BR
- UMA-62-JU
- UMA-62-SI
- UMA-62-KG
- UMA-62-PG



A	70	35	25
B	E	D	35
C	L	M	H

UMA-63

3 split tube folder

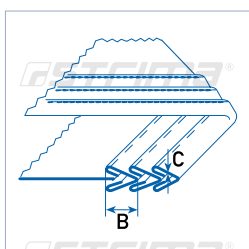

Machine: 6-12 needle chainstitch flat-bed machine



B	8	10	12	15
C	L	M		

UMA-64

2 split overlock folder



UMA-64-BR
 UMA-64-JU
 UMA-64-SI
 UMA-64-KG
 UMA-64-PG

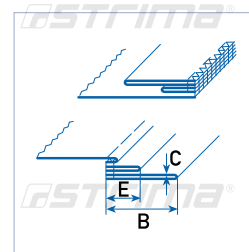

A 70 35

B E 35 17

C L M H

Machine: Overlock machine

UMA-65

Attachment for following

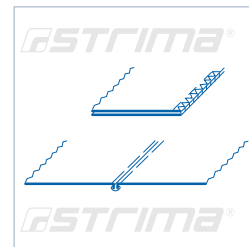

Machine: Flat bed coverstitch machine

UMA-227

Tape guide

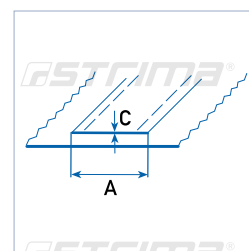

A 10 15 20 25 30 35 40

C L M H XH

Machine: Flat bed coverstitch machine

UMA-230

Tape guide

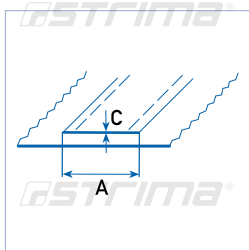

Machine: Lockstitch and 2-needle machines



A	5	6.5	8	10	12.5	15
C	L	M				

UMA-233

Multi tape attach folder

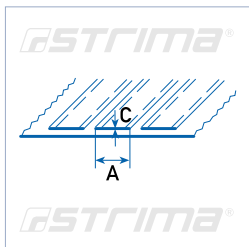

Machine: 6-12 needle chainstitch flat-bed machine



A	10	12
C	L	M

UMA-237

Lay on foot

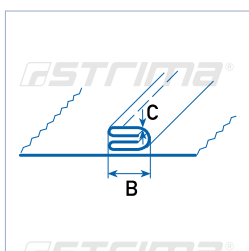

Machine: Standard lockstitch machine



A	15	18	20
B	4	5	6
C	L	M	

UMA-240

Piping attachment for lockstitch machine



A 20 25 30

B 10 12.5 15

C L M H

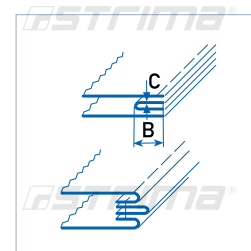

Machine: Standard lockstitch machine

UMA-243

Adjustable ready - made piping attachment



A 6 8 10 12 15

C L M

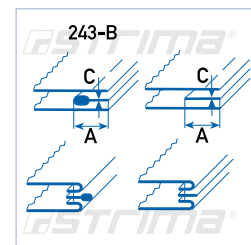

Machine: Standard lockstitch machine

UMA-244

Cord edge piping attachment



A 20 25 30

B 10 12.5 15

C L M H

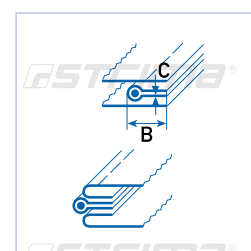

Machine: Standard lockstitch machine

UMA-251

Single upturn feller

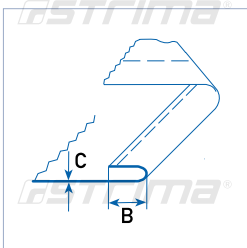

Machine: Standard lockstitch machine



B	6	8	10	15
C	L	M	H	

UMA-253

Plain hemmer

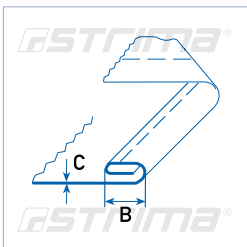

Machine: Standard lockstitch machine



B	5	6	8	10
C	L	M		

UMA-262

Shirring attachment

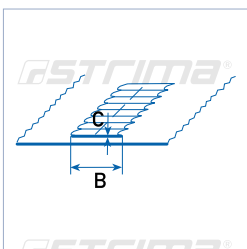

Machine: Walking foot lockstitch machine



B	25
C	L M H

UMA-290

Linking split - tube folder

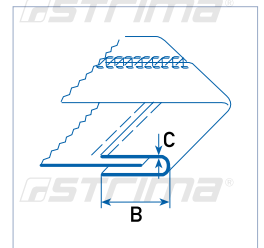

C M H XH

Machine: Flat bed coverstitch machine

<i>BSTRIMA®</i>	<i>BSTRIMA®</i>	<i>BSTRIMA®</i>	<i>BSTRIMA®</i>
<i>BSTRIMA®</i>	<i>BSTRIMA®</i>	<i>BSTRIMA®</i>	<i>BSTRIMA®</i>
<i>BSTRIMA®</i>	<i>BSTRIMA®</i>	<i>BSTRIMA®</i>	<i>BSTRIMA®</i>
<i>BSTRIMA®</i>	<i>BSTRIMA®</i>	<i>BSTRIMA®</i>	<i>BSTRIMA®</i>
<i>BSTRIMA®</i>	<i>BSTRIMA®</i>	<i>BSTRIMA®</i>	<i>BSTRIMA®</i>
<i>BSTRIMA®</i>	<i>BSTRIMA®</i>	<i>BSTRIMA®</i>	<i>BSTRIMA®</i>
<i>BSTRIMA®</i>	<i>BSTRIMA®</i>	<i>BSTRIMA®</i>	<i>BSTRIMA®</i>
<i>BSTRIMA®</i>	<i>BSTRIMA®</i>	<i>BSTRIMA®</i>	<i>BSTRIMA®</i>
<i>BSTRIMA®</i>	<i>BSTRIMA®</i>	<i>BSTRIMA®</i>	<i>BSTRIMA®</i>
<i>BSTRIMA®</i>	<i>BSTRIMA®</i>	<i>BSTRIMA®</i>	<i>BSTRIMA®</i>

Introduction of underwear attachments on product

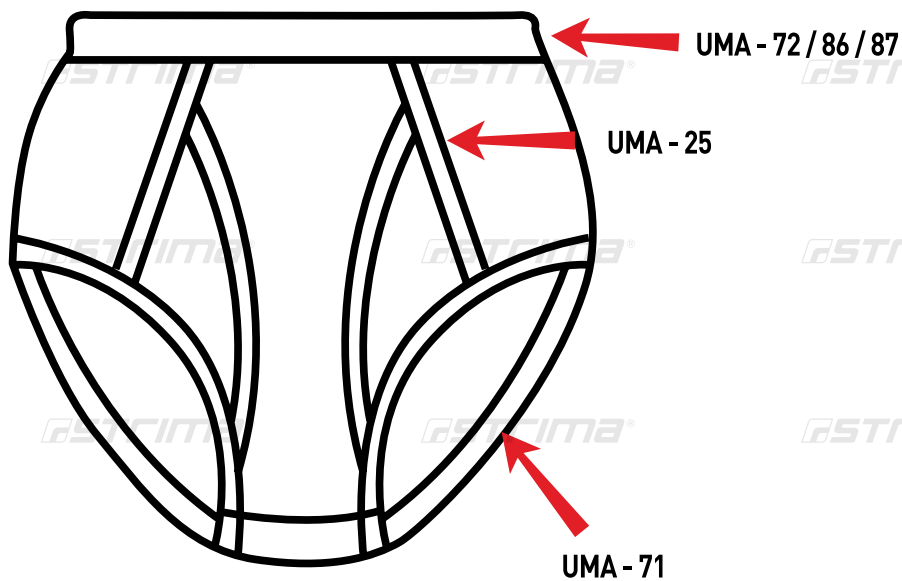
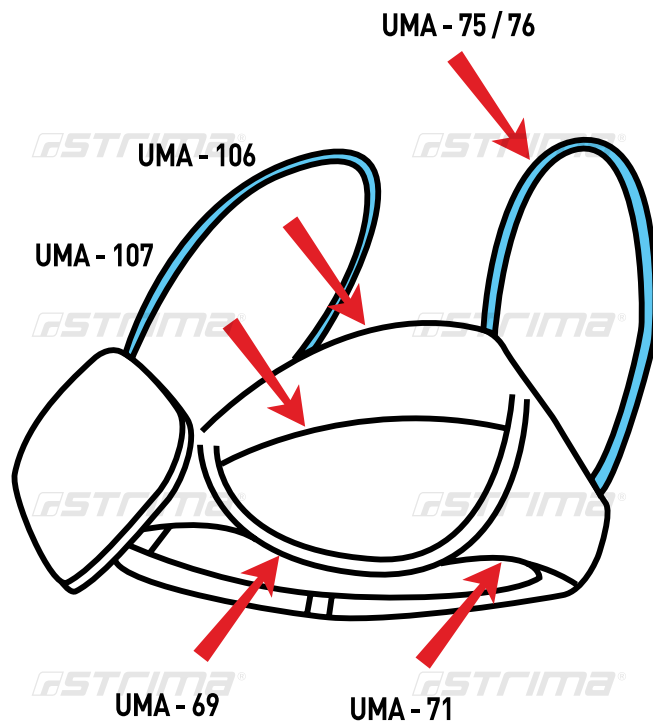

UMA-72

Split tube folder with elastic (double bottom)



UMA-68

Raw edge tape binder

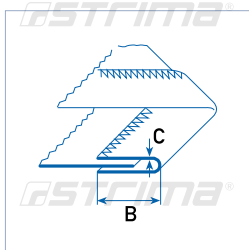

Machine: Zig-zag machine

A	12	15	18	20	22	25
B	6	7.5	9	10	11	12.5
C	L	M	H			

UMA-69

Right angle binder

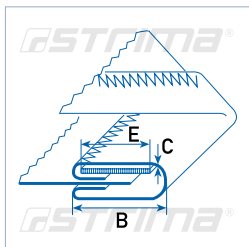

Machine: Zig-zag machine

A	25	28	30	32	35	40
B	6	7	8	9	10	12
E	4	5	6	7	8	10
C	L	M	H			

UMA-71

Split tube folder with elastic (single bottom)

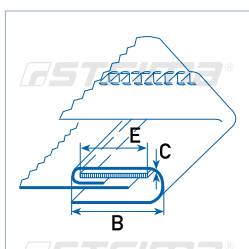

Machine: Flat bed coverstitch machine

A	25	28	30	32	35	40	45	50	55	60	65	70
B	7	9	10	12	13	15	17	20	22	25	27	30
E	5	7	8	10	11	13	15	18	20	23	25	28
C	L	M	H									

UMA-72

Split tube folder with elastic (double bottom)



A	25	28	30	32	35	40	45	50	55	60	65	70
B	6	7	8	9	10	12	13	15	17	20	22	25
E	4	5	6	7	8	10	11	13	15	18	20	23
C	L	M	H									

Machine: Flat bed coverstitch machine

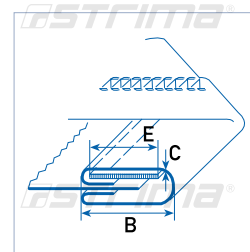

UMA-75

Spaghetti attachment



A	22	25	28	30	35	40
B	5	6	7	8	10	12
C	L	M				

Machine: Overlock machine

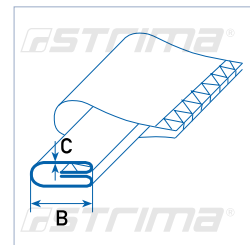

UMA-76

Spaghetti attachment with elastic



A	22	25	28	30	35	40
B	5	6	7	8	10	12
E	4	5	6	7	9	11
C	L	M				

Machine: Overlock machine

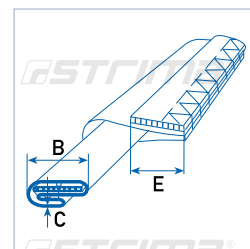

UMA-77

Folder with elastic for shoulder-straps

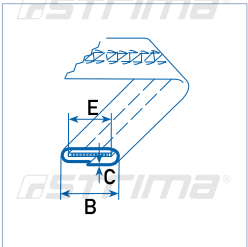

A	20	25	30	40
B	8	10	13	18
E	6	8	11	16
C	L	M		

Machine: Flat bed coverstitch machine

UMA-80

Adjustable elastic fitting (from bottom)

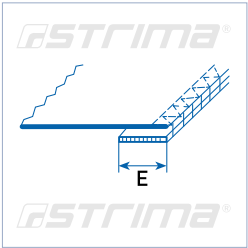

E	5 ~ 25 mm	25 ~ 50 mm
---	-----------	------------

Machine: Zig-zag, overlock and flat bed coverstitch machine

UMA-81

Adjustable elastic fitting (from top)

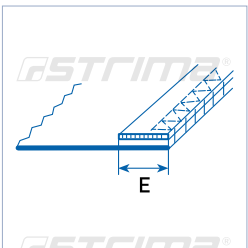

E	5 ~ 25 mm	25 ~ 50 mm
---	-----------	------------

Machine: Zig-zag, overlock and flat bed coverstitch machine

UMA-82

Elastic laces folder

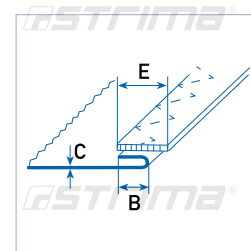
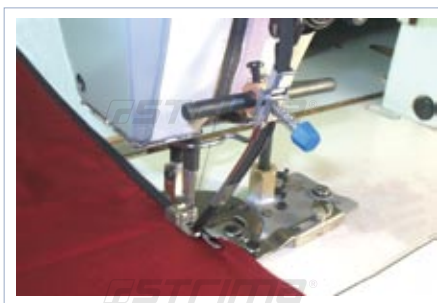

B 6

E 8 10

C L M

Machine: Zig-zag machine

UMA-84

Elastic laces folder

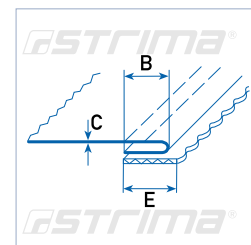

B 6 8 10

E 8 10 12

C L M H

Machine: Flat bed coverstitch machine

UMA-86

Downturn elastic hemmer

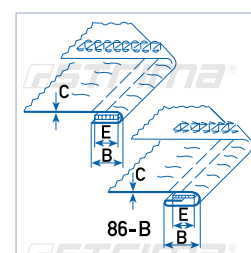
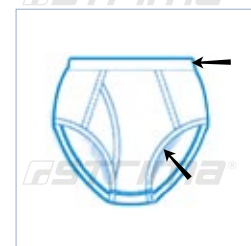

B 8 10 12 14 18 20

E 6 8 10 12 16 18

C L M H

Machine: Flat bed coverstitch machine

UMA-87

Downturn elastic hemmer

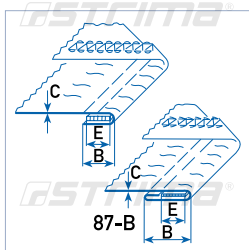

Machine: Flat bed coverstitch machine

B	8	10	12	14	18	22	27
E	6	8	10	12	16	20	25
C	L	M	H				

UMA-96

Right angle binder with lining

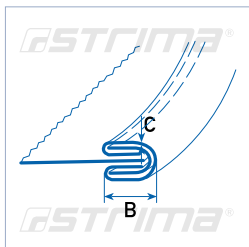

Machine: Flat bed coverstitch machine

A	28	30	35
B	7	8	10
C	L	M	

UMA-97

Tape folder with lining

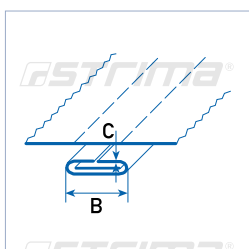

Machine: 2 needle machines

B	20	25	30
E	10	12.5	15
C	L	M	

UMA-100

Sleeve facing folder

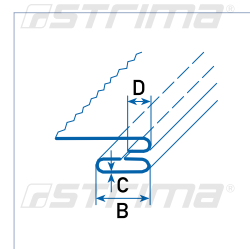

A 16 20 25

B 8 10 12.5

D 6

C L M

Machine: 2 needle machines

UMA-106

Stripper with lining & elastic (brassiere)

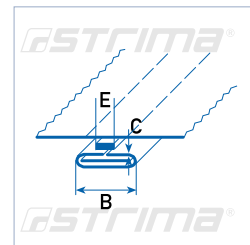

A 16 20 25

B 8 10 12.5

E 4 6 8

C L M

Machine: 2 needle machines

UMA-107

Stripper with cover plate (brassiere)

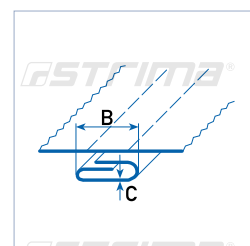

A 20 24 30

B 8 10 12.5

C L M

Machine: 2 needle machines

UMA-108

Stripper with cover plate (brassiere)

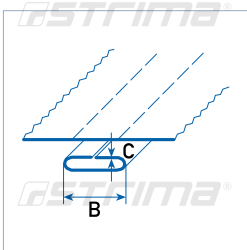

Machine: 2 needle machines



A 16 20 25

B 8 10 12.5

C L M

UMA-109

Stripper with cover plate (brassiere)

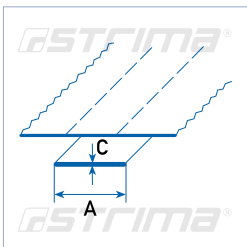

Machine: 2 needle machines



A 6 8 10

UMA-136

Double upturn spring hemmer (brassiere)

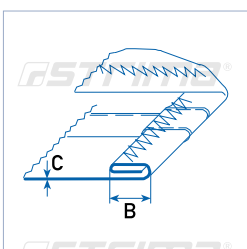

Machine: Zig-zag machine



B 6 8 10

C L M

UMA-118

Waistband folder for shaped strips



Introduction of jeans attachments on product

BSTRIMA® *BSTRIMA®* *BSTRIMA®* *BSTRIMA®*

UMA -110 / 111 / 112 / 115 / 118

UMA -121 / 122 / 123

UMA -151

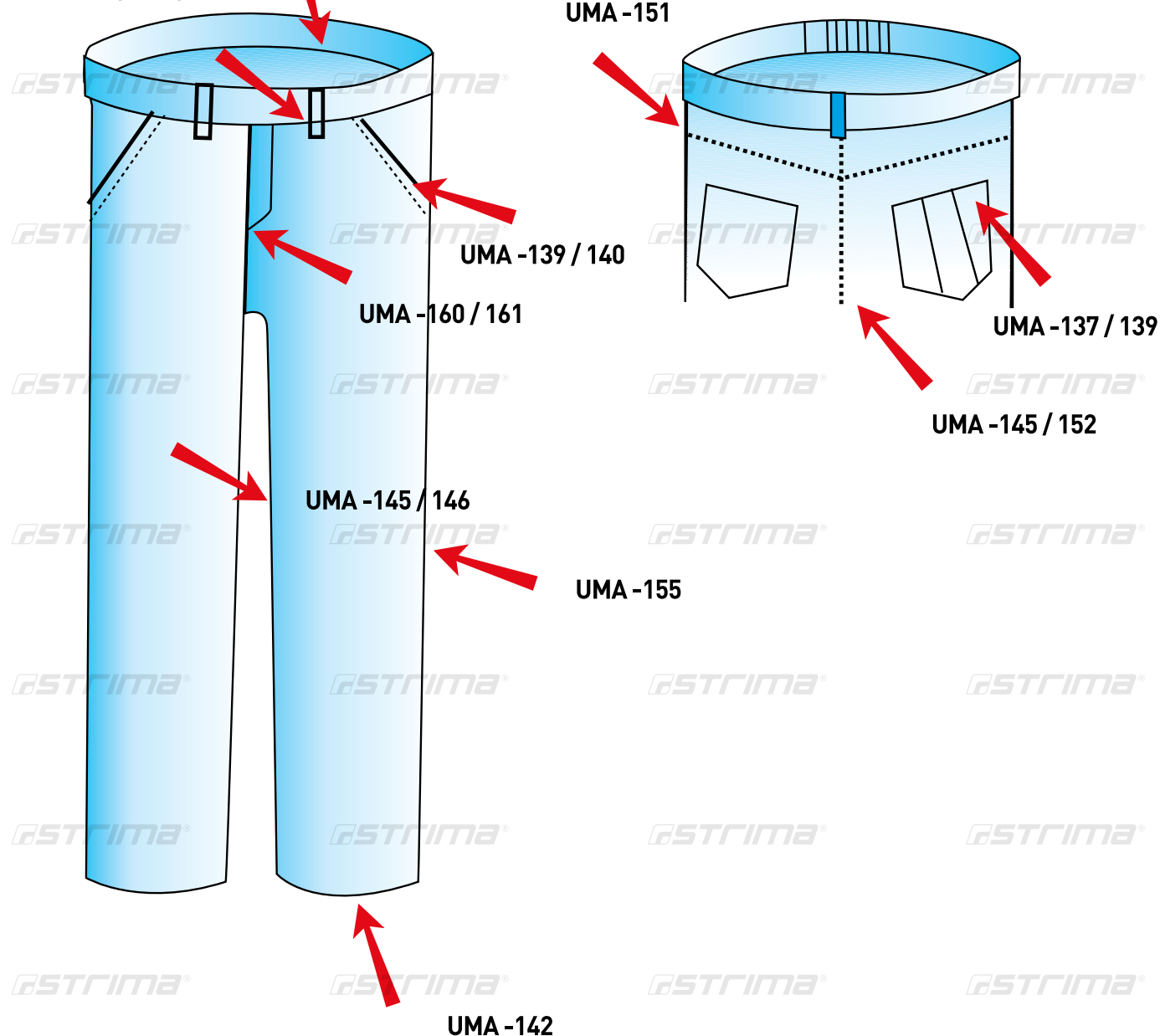

BSTRIMA® *BSTRIMA®* *BSTRIMA®* *BSTRIMA®*

BSTRIMA® *BSTRIMA®* *BSTRIMA®* *BSTRIMA®*

BSTRIMA® *BSTRIMA®* *BSTRIMA®* *BSTRIMA®*

UMA-110

Elbow binder for waistband



UMA-110

Elbow binder for waistband

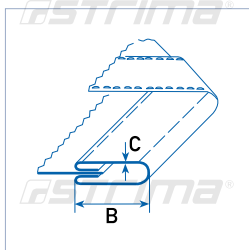

Machine: waistband machine

A	80	85	90	95	100	110	115	120	125	130
B	30	32	35	38	40	42	45	50	50	55
C	M	H	XH							

UMA-110-O

Elbow binder for waistband (automat)



UMA-110-O-BR
UMA-110-O-JU
UMA-110-O-SI
UMA-110-O-KG

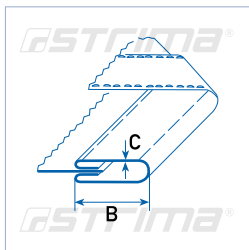

Machine: Automated waistband machine

A	80	85	90	95	100	110	115	120	125	130
B	30	32	35	38	40	42	45	50	50	55
C	M	H	XH							

UMA-110-K

Elbow binder for waistband (arched)

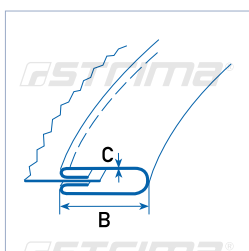

Machine: waistband machine

A	80	85	90	95	100	110	115	120	125	130
B	30	32	35	38	40	42	45	50	50	55
C	M	H	XH							

UMA-110-L

Elbow binder for waistband

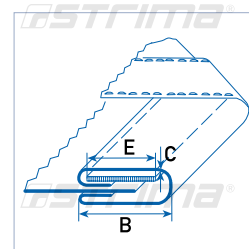
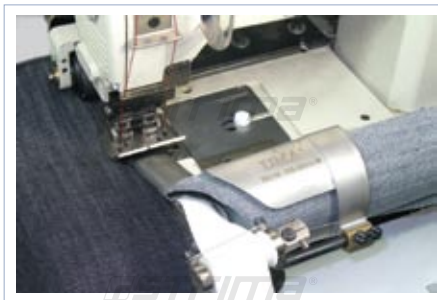

A	80	85	90	95	100	110	115	120	125	130
---	----	----	----	----	-----	-----	-----	-----	-----	-----

B	30	32	35	38	40	42	45	50	50	55
---	----	----	----	----	----	----	----	----	----	----

E	28	30	33	36	38	40	43	48	48	53
---	----	----	----	----	----	----	----	----	----	----

C	M	H	XH
---	---	---	----

Machine: waistband machine

UMA-110-LS

Elbow binder for waistband (elastic parts)

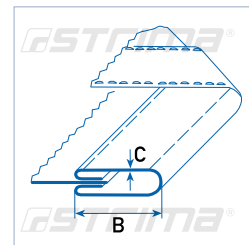

A	80	85	90	95	100	110	115	120	125	130
---	----	----	----	----	-----	-----	-----	-----	-----	-----

B	30	32	35	38	40	42	45	50	50	55
---	----	----	----	----	----	----	----	----	----	----

C	M	H	XH
---	---	---	----

Machine: waistband machine

UMA-110-KD

Elbow binder for waistband (velvet)

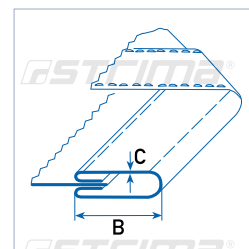

A	80	85	90	95	100	110	115	120	125	130
---	----	----	----	----	-----	-----	-----	-----	-----	-----

B	30	32	35	38	40	42	45	50	50	55
---	----	----	----	----	----	----	----	----	----	----

C	L	M	H	XH
---	---	---	---	----

Machine: waistband machine

UMA-165-K Elbow binder for waistband (linen)

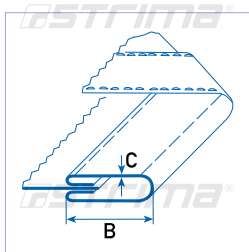

Machine: waistband machine

A	80	85	90	95	100	110	115	120	125	130
B	30	32	35	38	40	42	45	50	50	55
C	L	M	H							

UMA-111 Elbow binder for waistband

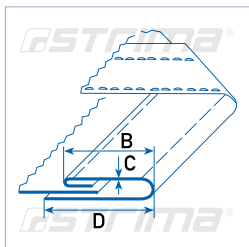

Machine: waistband machine

A	80	85	90	95	100	105	110	115	120	125	135	
B	D	30-40	32-42	35-45	38-48	40-50	42-52	42-55	45-55	50-60	50-60	55-65
C		M	H	XH								

UMA-112 Elbow binder for waistband

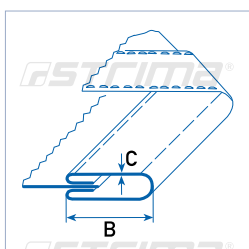
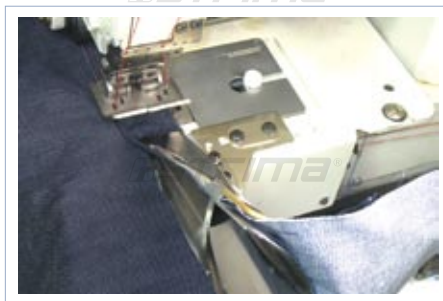

Machine: waistband machine

A	80	85	90	95	100	105	110
B	30	32	35	38	40	42	42
C	M	H	XH				

UMA-112-L

Elbow binder for waistband



A 90 95 100 105 110 120 130

B 35 38 40 42 42 45 50

C M H XH

Machine: Automated waistband machine

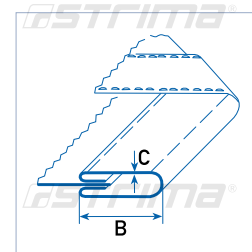

UMA-114

Bottom waistband folder



A 50 55 62 65 70 72

B 30 32 36 38 40 42

D 12

C M H XH

Machine: waistband machine

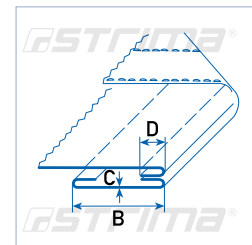

UMA-115

Two pieces waistband folder



A 62 65 70 72 75 80 85

B 36 38 40 42 45 50 55

C M H XH

Machine: waistband machine

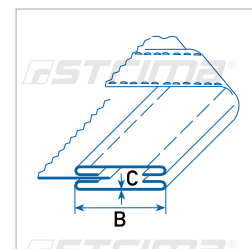

UMA-115-C

Two pieces waistband folder

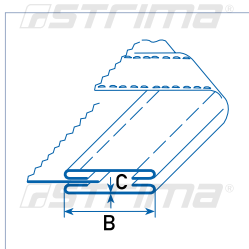

Machine: 2 needle chainstitch machine



A	62	65	70	72
B	36	38	40	42
C	M	H	XH	

UMA-116

Waistband folder

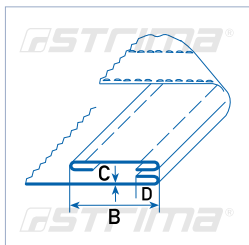
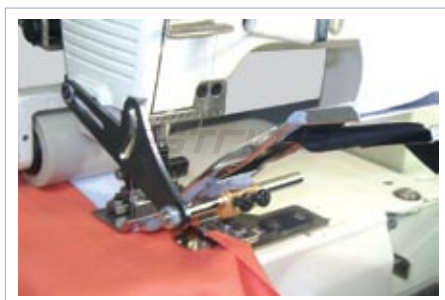

Machine: waistband machine



A	60	65	70
B	38	40	42
D	12		
C	M	H	XH

UMA-118

Waistband folder for shaped strips

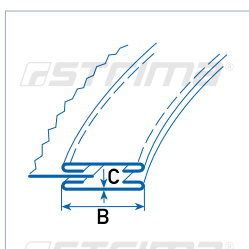

Machine: waistband machine



A	62	65	70	72	75	80	85
B	36	38	40	42	45	50	55
C	M	H	XH				

UMA-118-T

Waistband foder for shaped strips

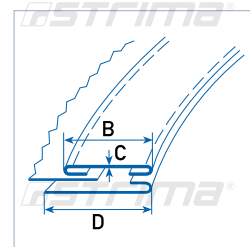

A 62 65 70 72 75 80 85

B D 36-46 38-48 40-50 42-52 45-55 50-60 55-65

C M H XH

Machine: waistband machine

UMA-121

Belt loop folder

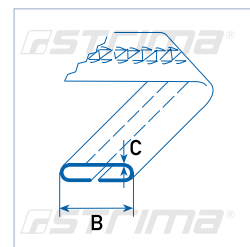

A 18 20 25 30 35 40

B 9 10 12.5 15 17.5 20

C M H XH

Machine: Belt loop machine with front cutter

UMA-121-B

Belt loop folder

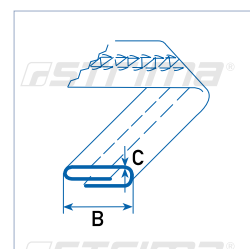

A 25 30 35 40 43

B 10 12 15 17 20

C M H XH

Machine: Belt loop machine with front cutter

UMA-121-U

Belt loop folder

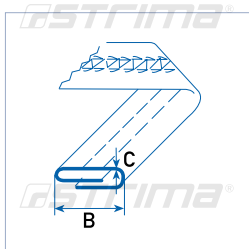

Machine: Belt loop Union machine with front cutter



A	25	30	35	40	43
B	10	12	15	17	20
C	H XH				

UMA-122

Belt loop folder for Juki

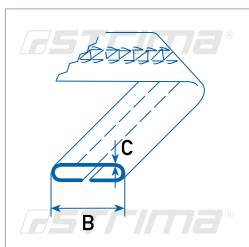

Machine: Belt loop Juki machine with front cutter



A	18	20	25	30	35	40
B	9	10	12.5	15	17.5	20
C	M H XH					

UMA-123

Belt loop folder

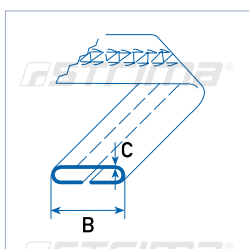

Machine: Flat bed coverstitch and 2 needle machines



A	20	25	30	35	40	50
B	10	12.5	15	17.5	20	25
C	M H XH					

UMA-124

Belt loop folder (clean folding)

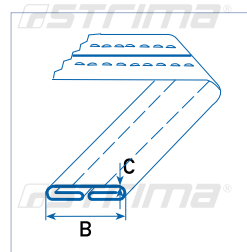

A 30 35 40 50

B 12 13 15 20

C M H XH

Machine: Flat bed coverstitch and 2 needle machines

UMA-126

Belt loop folder with lining (clean folding)

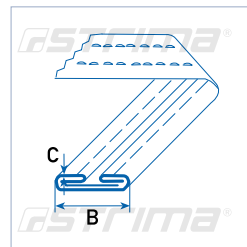

A 33 48 60

B 15 20 25

C M H XH

Machine: Flat bed coverstitch and 2 needle machines

UMA-127

Belt loop folder

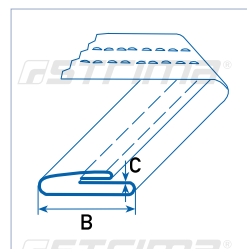

A 30 38 45 50 55 60

B 10 12 15 17 18 20

C M H XH

Machine: Standard lockstitch and 2 needle machines

UMA-130

Pocket binder

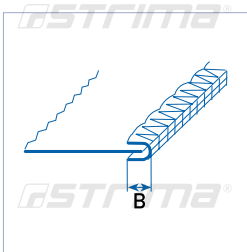

Machine: Pocket overlock machine



130-B

A	10	12
B	5	6

UMA-131

Pocket binder

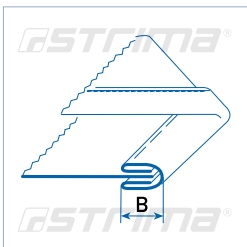

Machine: Pocket overlock machine



A	25	28	30
B	6	7	8

UMA-132

Pocket binder

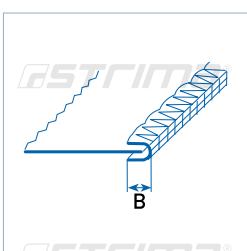

Machine: Overlock machine

- UMA-132-BR
- UMA-132-JU
- UMA-132-SI
- UMA-132-KG
- UMA-132-PG



A	10	12
B	5	6

UMA-133

waistband side edge binder

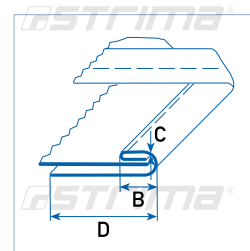

A 25 30

B 5-15 6-19

C L M

Machine: Standard lockstitch machine

UMA-137

Dwonturn hemmer for jeans patch-pockets

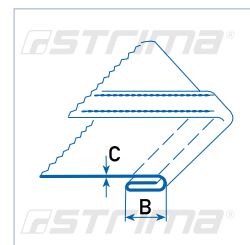
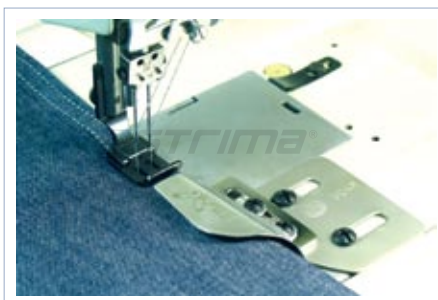

B 10 12 15

C M H XH

Machine: 2 needle chainstitch machine

UMA-139

Hemmer for front pocket

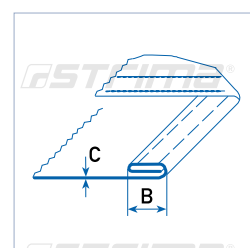

B 8 10 12 15

C M H XH

Machine: 2 needle machines

UMA-140

Sleeve facing folder set

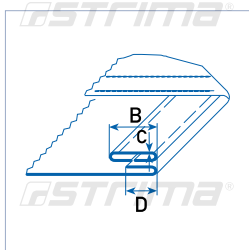
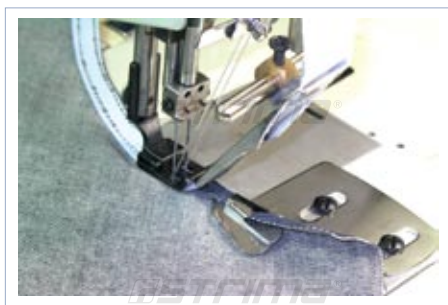

A	20	25
B	10	12
D	8	10
C	M	H

Machine: 2 needle machines

UMA-141

Jeans bottom hemming folder with foot for lockstitch machines

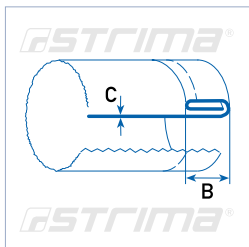

B	10	12
C	H	XH

Machine: Standard lockstitch machine

UMA-142

Jeans bottom hemming folder with pocket binder with airy system

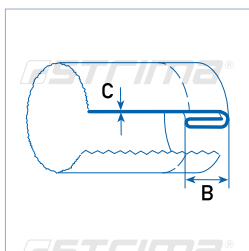

B	10 - 16
C	H XH

Machine: Union special - Brother - Juki bottom hemming

UMA-145

Spring type side seam folder

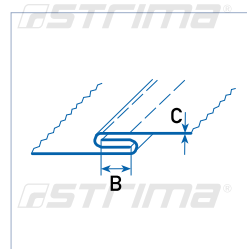

B 1/4 3/8 1/2

C H XH

Machine: 2,3 needle feed of the arm machine

UMA-145-L

Spring type side seam folder

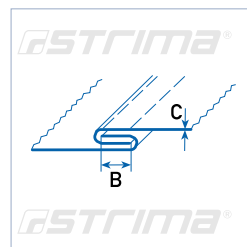

B 1/4 3/8 1/2

C H XH

Machine: 2,3 needle feed of the arm machine

UMA-146

Lap seam folder for arm machine

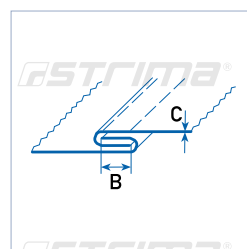

B 3/16 1/4 3/8 1/2

C M H XH

Machine: 2,3 needle feed of the arm machine

UMA-148

Lap seam folder

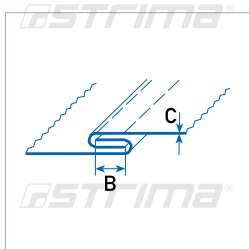

Machine: 2 needle chainstitch machine



B 3/16 1/4

C M H XH

UMA-149

Lap seam folder

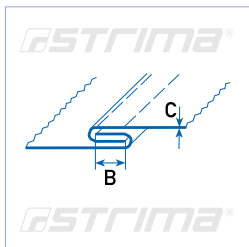

Machine: 2 needle chainstitch machine



B 3/16 1/4

C H XH

UMA-150

Lap seam folder

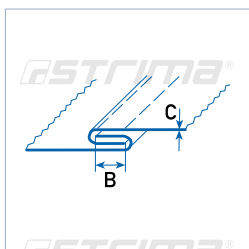
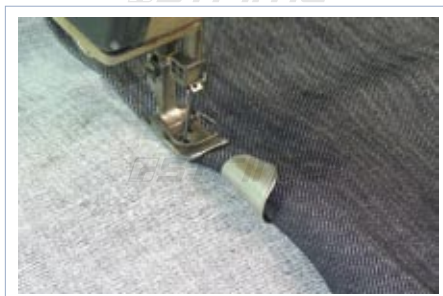
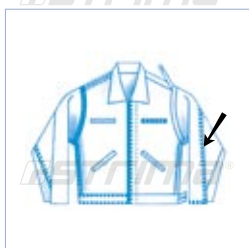

Machine: 2 needle chainstitch machine



B 3/16 1/4

C M H XH

UMA-151

Lap seam folder

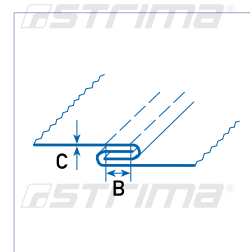
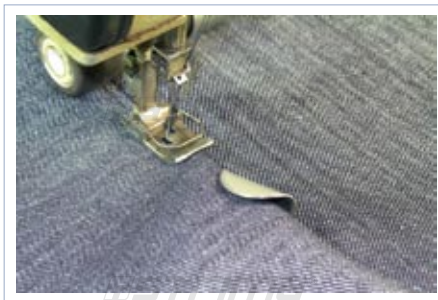

B 3/16 1/4

C H XH

Machine: 2 needle machines

UMA-152

Spring type side seam folder

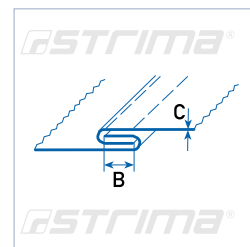

B 1/4

C H XH

Machine: 2,3 needle feed of the arm machine

UMA-153

Belt loop and edge tape folder

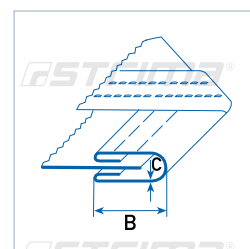

A 30 35 40

B 8 10 12

C M H XH

Machine: 2 needle chainstitch machine

UMA-155

Side seam sewing guide

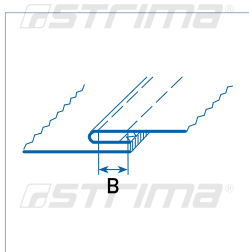

Machine: 2,3 needle feed of the arm machine



A	65	70	80
B	38	40	50

UMA-160

Adjustable top stitch joining attachment

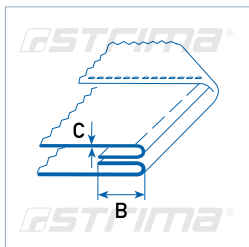

Machine: Standard lockstitch machine



B	8	10
C	M	H XH

UMA-161

Adjustable top stitch joining attachment

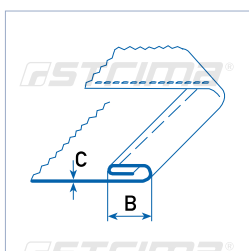

Machine: Standard lockstitch machine



B	6	8	10
C	M	H	XH

UMA-180

Double upturn spring hemmer

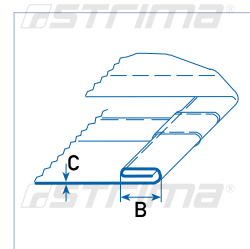

B 6 8 10 12

C M H XH

Machine: Standard lockstitch machine

<i>BSTRIMA</i>	<i>BSTRIMA</i>	<i>BSTRIMA</i>	<i>BSTRIMA</i>
<i>BSTRIMA</i>	<i>BSTRIMA</i>	<i>BSTRIMA</i>	<i>BSTRIMA</i>
<i>BSTRIMA</i>	<i>BSTRIMA</i>	<i>BSTRIMA</i>	<i>BSTRIMA</i>
<i>BSTRIMA</i>	<i>BSTRIMA</i>	<i>BSTRIMA</i>	<i>BSTRIMA</i>
<i>BSTRIMA</i>	<i>BSTRIMA</i>	<i>BSTRIMA</i>	<i>BSTRIMA</i>
<i>BSTRIMA</i>	<i>BSTRIMA</i>	<i>BSTRIMA</i>	<i>BSTRIMA</i>
<i>BSTRIMA</i>	<i>BSTRIMA</i>	<i>BSTRIMA</i>	<i>BSTRIMA</i>
<i>BSTRIMA</i>	<i>BSTRIMA</i>	<i>BSTRIMA</i>	<i>BSTRIMA</i>
<i>BSTRIMA</i>	<i>BSTRIMA</i>	<i>BSTRIMA</i>	<i>BSTRIMA</i>
<i>BSTRIMA</i>	<i>BSTRIMA</i>	<i>BSTRIMA</i>	<i>BSTRIMA</i>

Introduction trousers attachment on product

UMA - 117 / 120

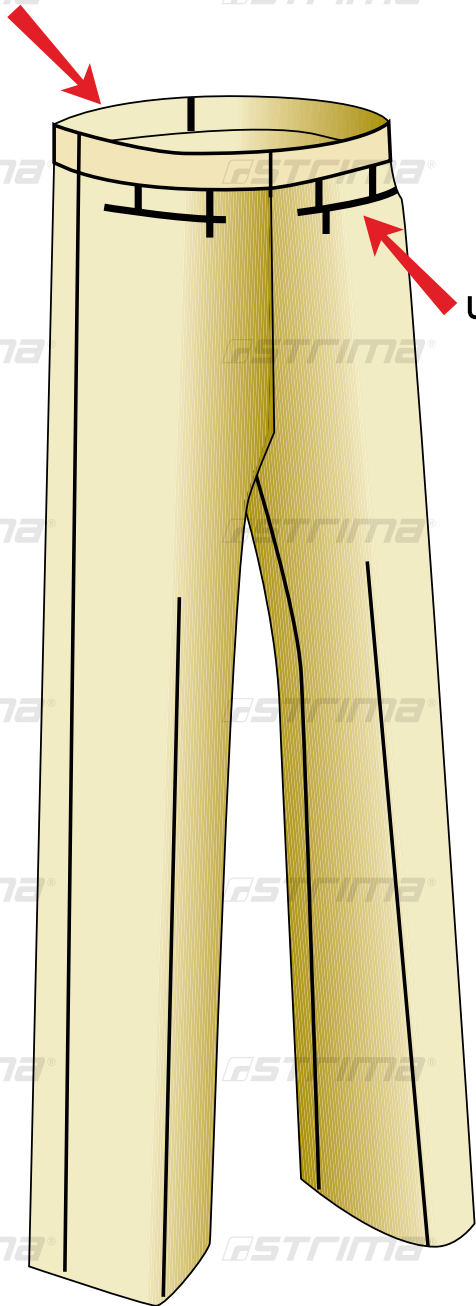

UMA - 125

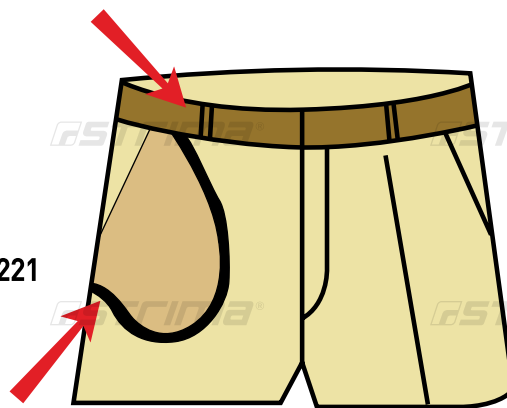

UMA - 221

UMA - 131

UMA-117

Adjustable waistband folder

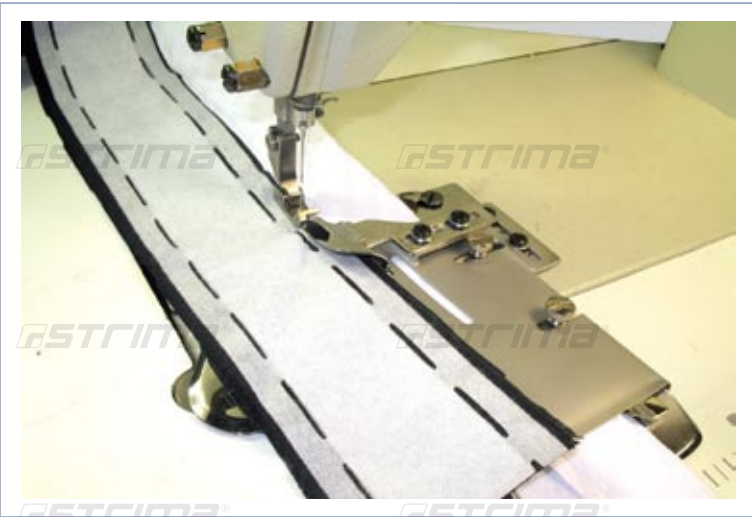

UMA-117

Adjustable waistband folder

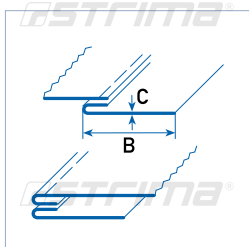

Machine: Standard lockstitch machine

B 50 ~ 70 mm



UMA-117-K

Adjustable waistband folder

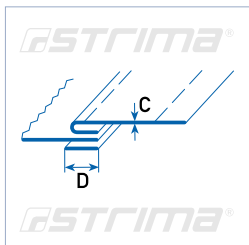

Machine: Waistband machine

B 50 ~ 70 mm

D 10 12



UMA-119

Adjustable waistband folder (special)

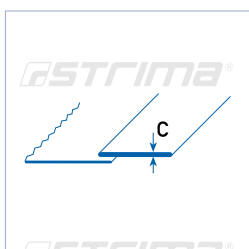

Machine: Zig-zag and standard lockstitch machine

D 50 ~ 70 mm



UMA-120

Casual trousers waistband folder

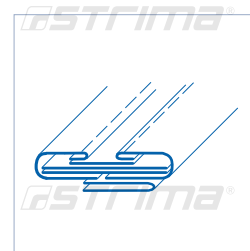

Machine: Waistband machine

UMA-120-B

Casual trousers waistband folder



Machine: Waistband machine



UMA-123

Belt loop folder

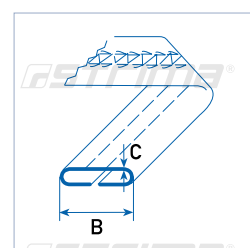

Machine: Flat bed coverstitch and 2 needle machines

A 20 25 30 35 40 50

B 10 12.5 15 17.5 20 25

C L M H

UMA-125

Belt loop folder for blindstitch machines

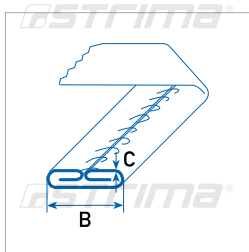

Machine: Blindstitch machine



A 32 36

B 8 10

C L M H

UMA-130

Pocket blinder

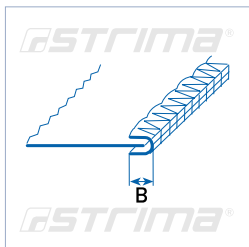

Machine: Pocket overlock machine

A 10 12

B 5 6



UMA-131

Pocket blinder

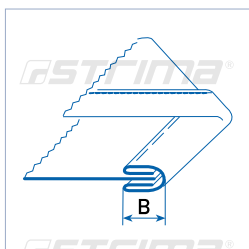

Machine: Pocket overlock machine

A 25 28 30

B 6 7 8



UMA-131-P

Pocket binder

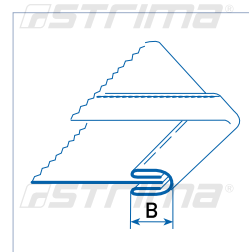

A 25 28 30

B 6 7 8

Machine: Pegasus overlock machine

UMA-131-Y

Pocket binder

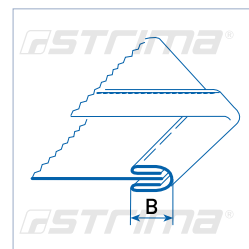

A 25 28 30

B 6 7 8

Machine: Yamato overlock machine

UMA-132

Pocket binder



- UMA-132-BR
- UMA-132-JU
- UMA-132-SI
- UMA-132-KG
- UMA-132-PG

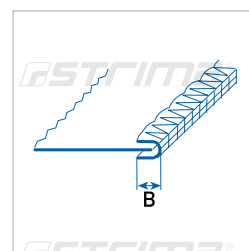

A 10 12

B 5 6

Machine: Overlock machine

UMA-133

Waistband side edge blinder

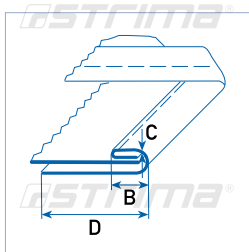

A 25 30

B 5-10 6-19

C L M

Machine: Standard lockstitch machine

UMA-165

Elbow blinder for waistband

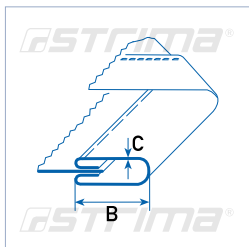

A 80 85 90 95 100 110

B 30 32 35 38 40 42

C M H

Machine: Standard lockstitch machine

UMA-220

Double-piped pocket folder

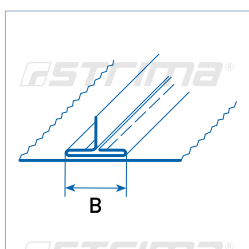

Machine: 2 needle machines

Stock of binders and hemmers – Strima sp. z o.o. Head Office, Swadzim



STRIMA®

STRIMA®

STRIMA®

STRIMA®

STRIMA®

STRIMA®

STRIMA®

STRIMA®

Introduction of shirt attachment on product

BSTRIMA® BSTRIMA® BSTRIMA® BSTRIMA®

BSTRIMA® BSTRIMA® BSTRIMA® BSTRIMA®

BSTRIMA® BSTRIMA® BSTRIMA® BSTRIMA®



UMA - 353 / 360

UMA - 211

UMA - 192

BSTRIMA® BSTRIMA® BSTRIMA® BSTRIMA®

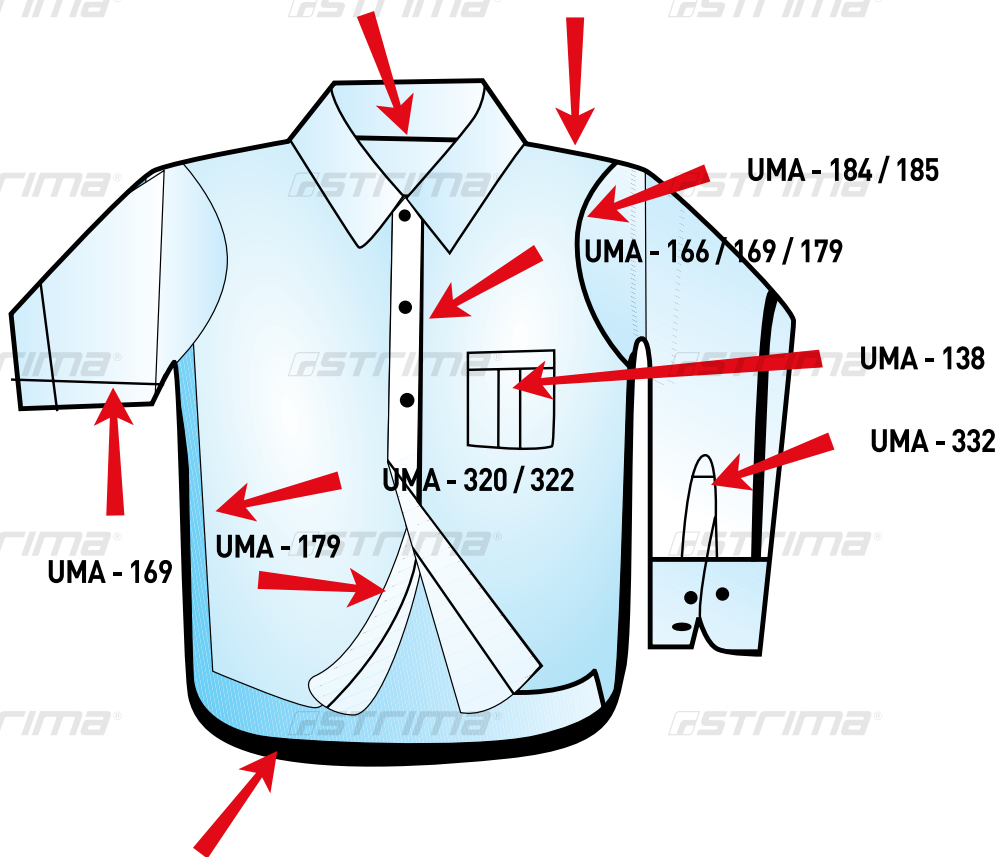

BSTRIMA® BSTRIMA® BSTRIMA® BSTRIMA®

BSTRIMA® BSTRIMA® BSTRIMA® BSTRIMA®

BSTRIMA® UMA - 210 BSTRIMA® BSTRIMA® BSTRIMA® BSTRIMA®

BSTRIMA® BSTRIMA® BSTRIMA® BSTRIMA®

BSTRIMA® BSTRIMA® BSTRIMA® BSTRIMA®

UMA-210

Pneumatic hemmer - set



UMA-112-C

Top center plait folder

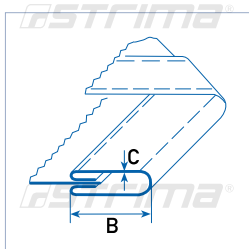

Machine: 2 needle machines



A	60	65	70	75	80	85	90	95	100
B	20	22	25	27	30	32	35	38	40
C	L	M	H						

UMA-138

Box pleat folder

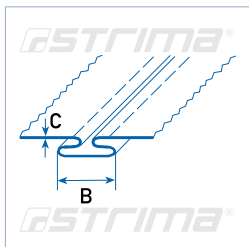

Machine: 2 needle machines



UMA-165

Top center plait folder

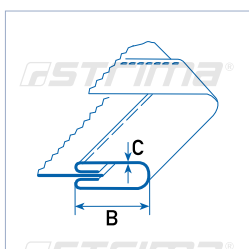

Machine: Standard lockstitch machine



A	60	65	70	75	80	85	90	95	100
B	20	22	25	27	30	32	35	38	40
C	L	M	H						

UMA-165-C

Top center plait folder

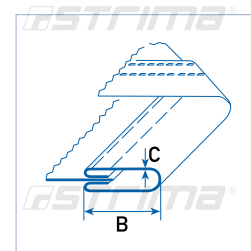

A 60 65 70 75 80 85 90 95 100

B 20 22 25 27 30 32 35 38 40

C L M H

Machine: 2 needle machines

UMA-166

Top center plait folder

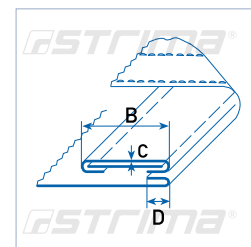
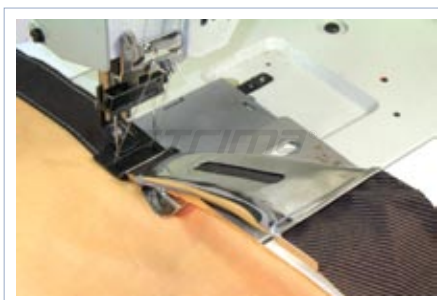

A 52 60 62 65

B 28 35 38 40

D 10 12

C L M H

Machine: 2 needle machines

UMA-169

Plait folder

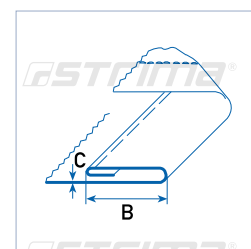

B 10 12 15 20 25 28 30 35 40

C L M H

Machine: Standard lockstitch machine

UMA-171

Plait folder with interlining

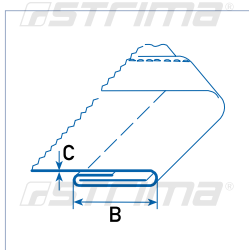

Machine: Standard lockstitch and 2 needle machines

B	20	22	25	28	30	32	35	38
C	L	M	H					

UMA-172

Top center plait hemmer

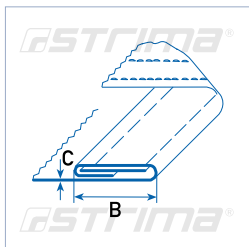

Machine: 2 needle machines

B	20	22	25	28	30	32	35	38
C	L	M	H					

UMA-176

Plait folder with interlining

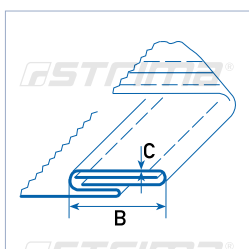

Machine: 2 needle machines

B	30	35	40					
C	L	M	H					

UMA-177

Button stay hemmer

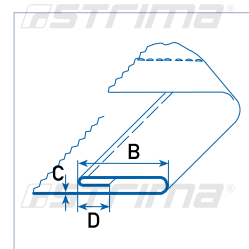

B	D	25-10	28-10	30-10	32-10	35-10
C		L	M	H		

Machine: Standard lockstitch machine

UMA-179

Plait folder

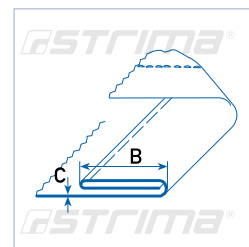

B	10-10	15-15	20-20	25-25	30-30	35-35	40-40	50-50
C	L	M	H					

Machine: Standard lockstitch machine

UMA-182

Short tail swing hemmer

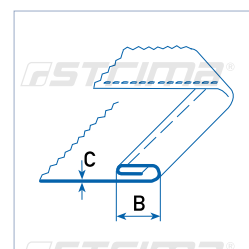

B	3	4	5	6	8
C	L	M			

Machine: Standard lockstitch machine

UMA-184

Yoke attachment

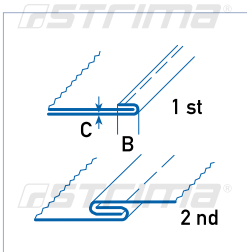

Machine: 2 needle machines



B	6
C	L M

UMA-185

Yoke attachment for twin needle machines

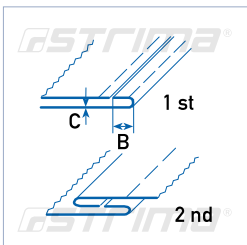

Machine: 2 needle chainstitch machine



B	6
C	L M

UMA-185-C

Yoke attachment for twin needle machines

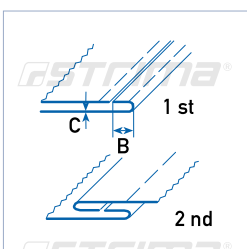

Machine: 2 needle chainstitch machine



B	6
C	L M

UMA-187

Single needle sleeve attachment - single needle operation



C L M

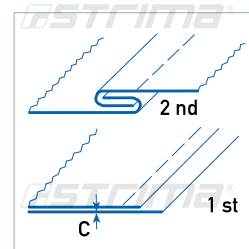

Machine: Standard lockstitch machine

UMA-192

Right top stitch joiner



B 10

C L M

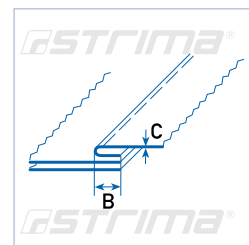

Machine: Standard lockstitch machine

UMA-198

Right top stitch joiner



B 10

C L M

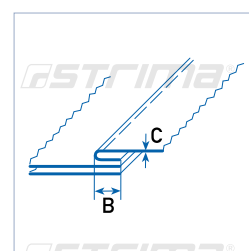

Machine: Standard lockstitch machine

UMA-201

Lap seam folder

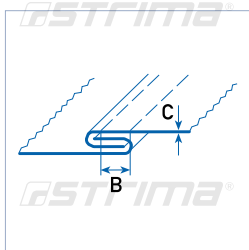

Machine: 2,3 needle feed of the arm machine



B	3/16	1/4
C	L	M

UMA-206

Triangular sleeve placket folder

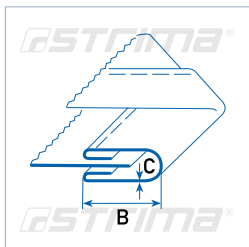

Machine: Rolier press machines



A	30	35	40
B	8	10	12
C	L	M	

UMA-210

Pneumatic hemmer - set

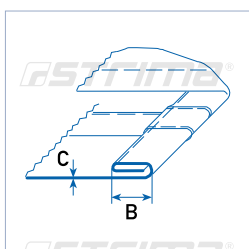

Machine: Standard lockstitch machine

B	5	6	7
C	L	M	H



UMA-210-B

Pneumatic hemmer set

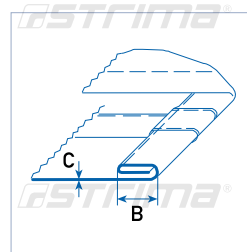

B 6

C L M H

Machine: Walking foot lockstitch machine

UMA-211

Pneumatic yoke attachment - set

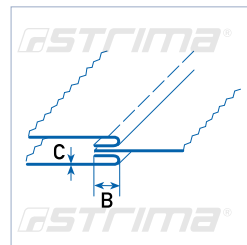

B 10

C L M H

Machine: Standard lockstitch machine

UMA-211-C

Pneumatic yoke attachment - set

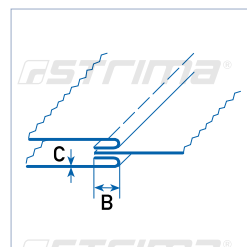

B 10

C L M H

Machine: 2 needle machines

UMA-215

Bias blinder double bottom fold

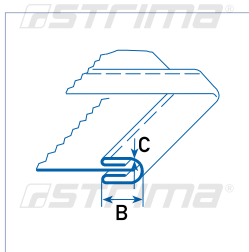

Machine: Standard lockstitch machine



A	25	28	30	35	40
B	6	7	8	10	12
C	L	M			

UMA-261

Pin tuck attachment

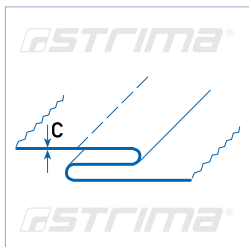

Maszyna: Stebnówka
Machine: Standard lockstitch machine



C	L	M
---	---	---

UMA-262

Shirring attachment

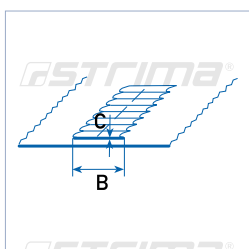

Machine: Walking foot lockstitch machine



B	25
C	L M H

UMA-320 Hemmer



B 6
C L M H

UMA-322 Foot

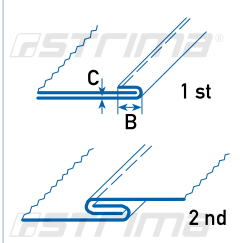

Machine: Standard lockstitch machine

UMA-324 Collar guide



Machine: Standard lockstitch machine

UMA-326 Cuff guide



Machine: Standard lockstitch machine

UMA-330 Pneumatic hemmer - set



Machine: 2,3 needle feed of the arm machine

UMA-332 Placket edge stitch guld



Machine: Standard lockstitch machine

UMA-334 Placket button hole spacing gauge



Machine: Flat buttonhole sewing machine

UMA-336 Cuff button hole spacing gauge

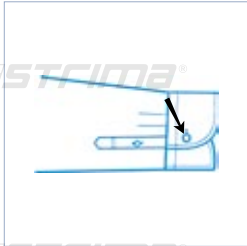

Machine: Flat buttonhole sewing machine

UMA-338 Cuff button spacing gauge



Machine: Button attaching machine

UMA-340

Collar tip button hole spacing gauge



Machine: Flat buttonhole sewing machine

UMA-342

Collar tip button hole spacing gauge



Machine: Button attaching machine

UMA-344

Placket button hole spacing gauge



Machine: Flat buttonhole sewing machine

UMA-345

Adjustable placket button hole spacing gauge



Machine: Flat buttonhole sewing machine

UMA-346

Placket button spacing gauge



Machine: Button attaching machine

UMA-348

Collar tip button spacing gauge



Machine: Flat buttonhole sewing machine

UMA-350

Stitch baleen foot



Machine: Standard lockstitch machine

UMA-352

Top stitch foot



Machine: Standard lockstitch machine

UMA-353

Collar attach pressure foot



Machine: Standard lockstitch machine

UMA-355

Edge stitch foot



Machine: Standard lockstitch machine

UMA-356

Pressure foot with right guide



Needle gauge 1/4 3/8 1/2

Machine: 2 needle chainstitch machine

UMA-358

Plain machine needle plate and feed dog



Distance between needle and foot guide 3/8 1/2

Machine: Standard lockstitch machine

UMA-360-A

Collar band stitch guide



Machine: Standard lockstitch machine

UMA-360-B

Collar band top stitch guide



Machine: Standard lockstitch machine

UMA-361

Cuff edge stitch foot with left



Machine: Standard lockstitch machine

UMA-365

Walking foot edge stitch with right guide



Distance between needle and foot guide 3/8 1/2

Machine: Walking foot lockstitch machine

UMA-366

Walking foot edge



Machine: Walking foot lockstitch machine

UMA-367

Walking foot edge stitch with right guide



Machine: Walking foot lockstitch machine

UMA-368

Walking edge stitch pressure



Machine: Walking foot lockstitch machine

UMA-369

Walking edge stitch pressure foot for skirt

UMA-369-S **Stitch plate and feed dog**



Machine: Walking foot lockstitch machine

UMA-370

Walking foot edge



Machine: Walking foot lockstitch machine

UMA-371

Walking edge pressure foot for skirt



Machine: Walking foot lockstitch machine

UMA-372

Left compensated pressure foot



Machine: Standard lockstitch machine

UMA-374

Pressure foot with right guide



Machine: Standard lockstitch machine

UMA-382

Left compensated pressure



Machine: Standard lockstitch machine

UMA-384

Double needle sleeve attachment set

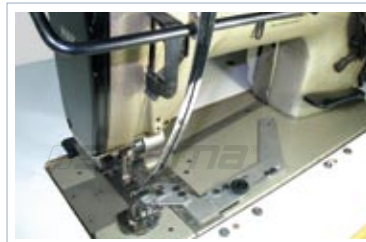

Machine: 2 needle chainstitch machine

UMA-386

Foot with guide



Machine: Standard lockstitch machine



UMA-358

Plain machine needle plate and feed dog



UMA-365

Walking foot edge stitch with right guide



Introduction of dress attachments on product

UMA - 04 / 215 / 216



UMA - 136

UMA-217

Bias binder double bottom fold



UMA-54

Hemmer for knitted fabric

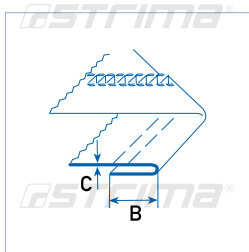

Machine: Standard lockstitch or 2 needle coverstitch machine

B	10	15	20	25
C	L	M	H	

UMA-55

Hemmer for knitted fabric

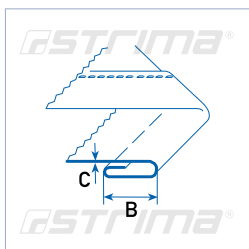

Machine: Standard lockstitch or 2 needle coverstitch machine

B	10	15	20
C	L	M	H

UMA-61

Adjustable elastic shirring foot

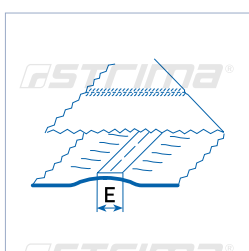

Machine: Standard lockstitch or 2 needle coverstitch machine

E	5	6.5	8	10
----------	---	-----	---	----

UMA-75

Spaghetti attachment



A	22	25	28	30	35	40
B	5	6	7	8	10	12
C	L	M				

Machine: Overlock machine

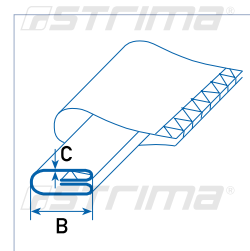

UMA-138

Box pleat folder



Machine: 2 needle machines

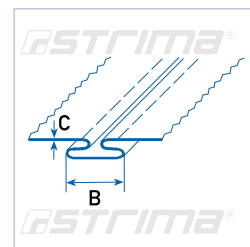

UMA-180

Double upturn spring hemmer



B	6	8	10
C	M	H	

Machine: Standard lockstitch machine

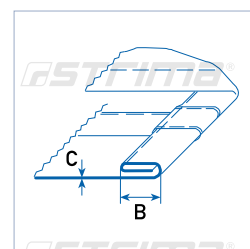

UMA-210

Pneumatic hemmer - set

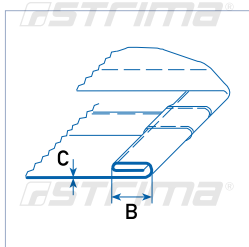

Machine: Standard lockstitch machine

B	5	6	7
C	M	H	

UMA-214

Bias binder single bottom fold

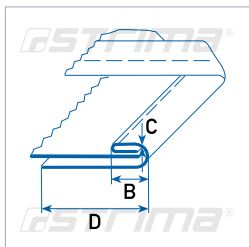

Machine: Standard lockstitch machine

A	20	22	26	30	32	36	40
B	D	5-11	6-11	7-13	8-15	9-15	10-15
C		M	H				

UMA-215

Bias binder double bottom fold

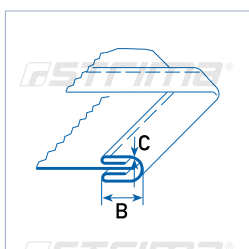

Machine: Standard lockstitch machine

A	25	28	30	35	40	45	50
B	6	7	8	10	12	13	15
C	M	H					

UMA-216

Tape or braid binder

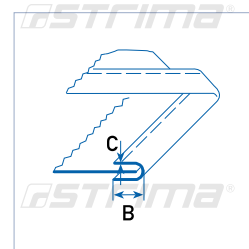

A 12 14 15 16 18 20 22 25 30

B 6 7 7.5 8 9 10 11 12.5 15

C M H

Machine: Standard lockstitch machine

UMA-217

Bias binder double bottom fold

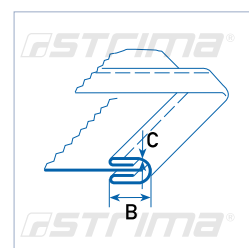

A 25 28 30 35 40 45 50

B 6 7 8 10 12 13 15

C M H

Machine: Standard lockstitch machine

UMA-239

Tape or braid binder

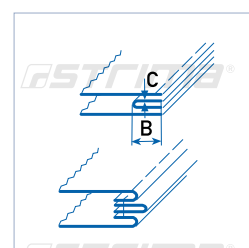
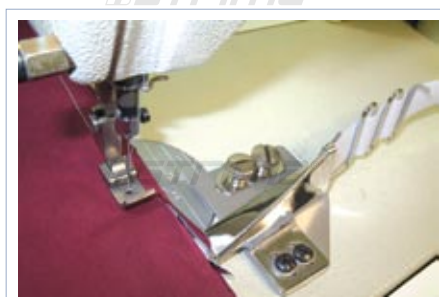

A 15 18 20 25 30

B 7.5 9 10 12.5 15

C L M

Machine: Standard lockstitch machine

UMA-251

Single upturn feller

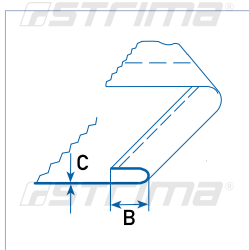

Maszyna: Stebnówka
Machine: Standard lockstitch machine

B	6	8	10	15
C	L	M	H	

UMA-253

Plain hemmer

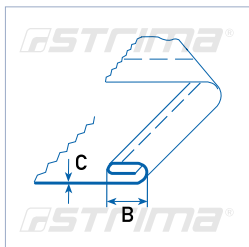

Machine: Standard lockstitch machine

B	5	6	8	10
C	L	M		

UMA-255

Plain hemmer

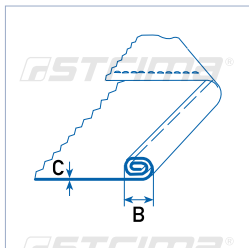

Machine: Standard lockstitch machine

B	2	3
C	L	M

UMA-261

Pin tuck attachment



C L M

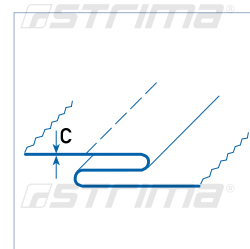

Machine: Standard lockstitch machine

UMA-262

Shirring attachment



B 25

C L M H

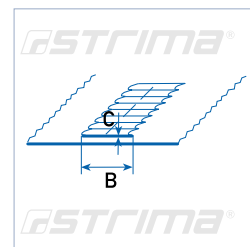

Machine: Walking foot lockstitch machine

Introduction of sportwear on product

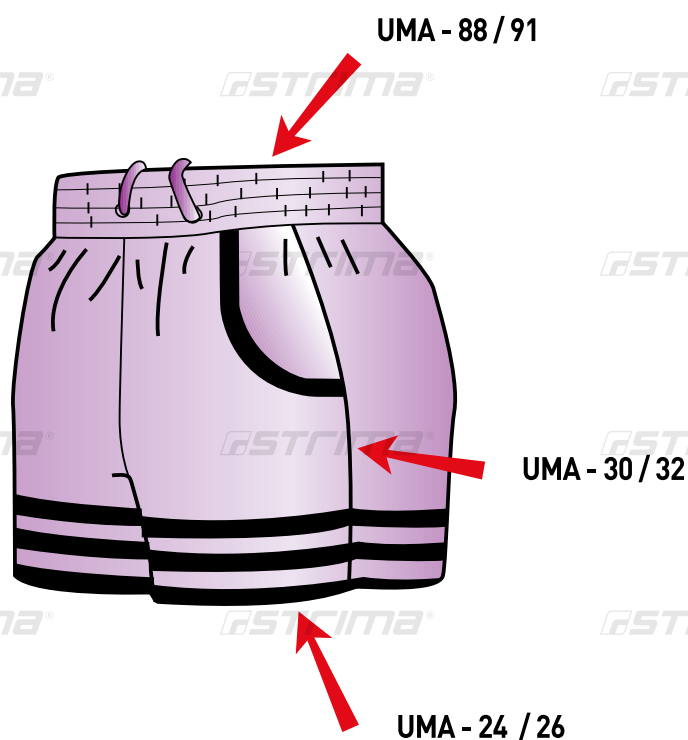
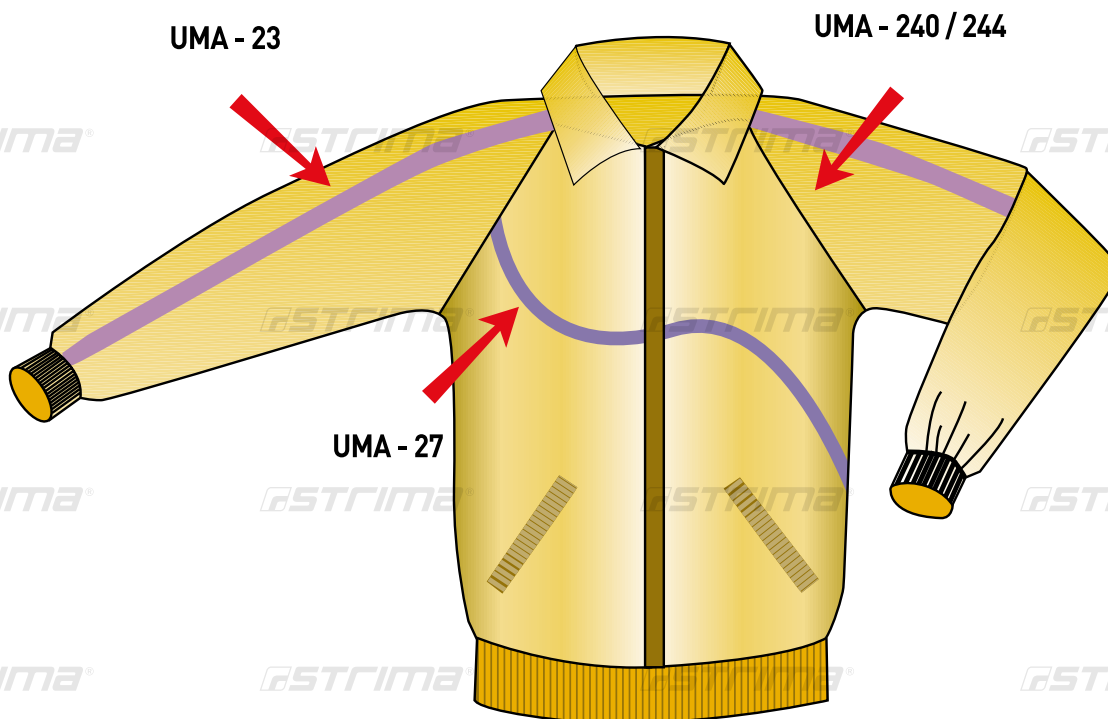



UMA-23

Multi tape attach folder

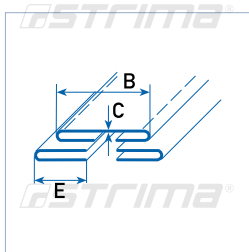
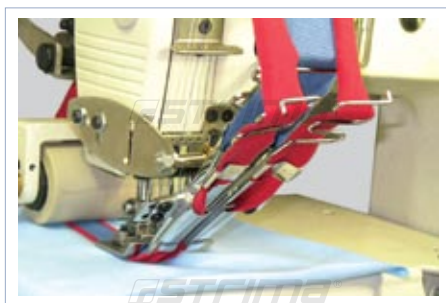

A	30	35	40	D	15	20	25
B	15	17.5	20	E	7.5	10	12.5
C	L	M	H				

Machine: Multi needle machines

UMA-23-B

Multi tape attach folder

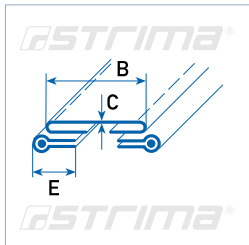
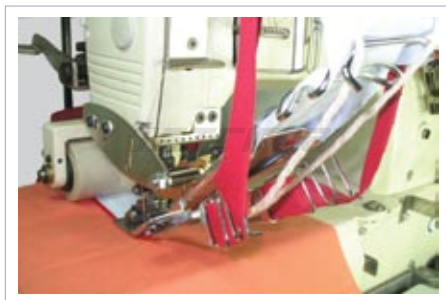

A	30	35	40	D	15	20	25
B	15	17.5	20	E	7.5	10	12.5
C	L	M	H				

Machine: Multi needle machines

UMA-24

Multi tape attach folder set

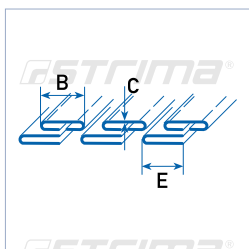
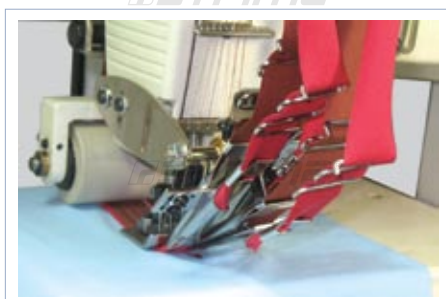

A	20	25	30	D	15	20	25
B	10	12.5	15	E	7.5	10	12.5
C	L	M	H				

Machine: Multi needle machines

UMA-25

Tape folder



A 15 18 20 22 25 28 30 40 50

B 7.5 9 10 11 12.5 14 15 20 25

C L M H

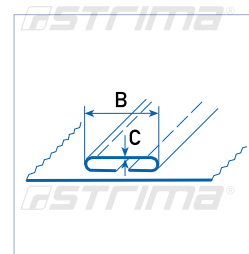

Machine: Flat bed coverstitch machine

UMA-26

Multi tape attach folder set



A 15 20 25 30

B 7.5 10 12.5 15

C L M H

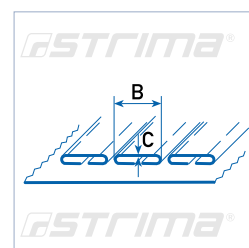

Machine: Multi needle machines

UMA-30

Piping attachment



UMA-30-BR
UMA-30-JU
UMA-30-SI
UMA-30-KG
UMA-30-PG

A 20 25 30 35 40 50

B 10 12.5 15 17.5 20 25

C L M H

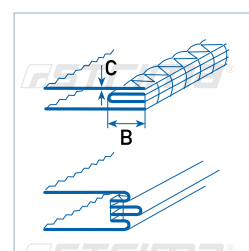

Machine: Overlock machine

UMA-32

Adjustable ready - made cord edge piping attachment

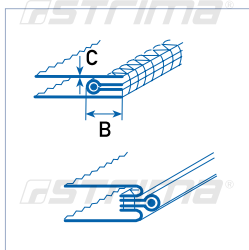

UMA-32-BR
 UMA-32-JU
 UMA-32-SI
 UMA-32-KG
 UMA-32-PG

A	20	25	30	35	40
B	10	12.5	15	17.5	20
C	L	M	H		

Machine: Overlock machine

UMA-33

Adjustable ready - made cord edge piping attachment

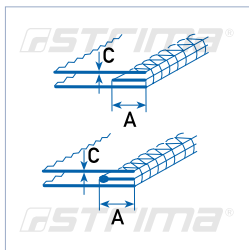

UMA-33-BR
 UMA-33-JU
 UMA-33-SI
 UMA-33-KG
 UMA-33-PG

A	6	8	10	12	15
C	L	M			

Machine: Overlock machine

UMA-34

Double piping attachment

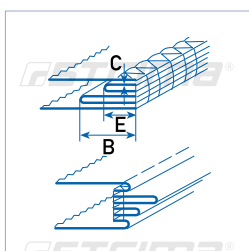

UMA-34-BR
 UMA-34-JU
 UMA-34-SI
 UMA-34-KG
 UMA-34-PG

A	20	25	30	35	40	D	20	25	30	35	40
B	10	12.5	15	17.5	20	E	10	12.5	15	17.5	20
C	L	M									

Machine: Overlock machine

UMA-88

Bottom elastic waistband folder

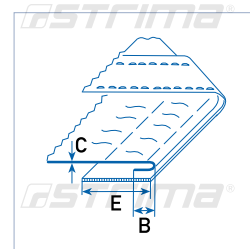

E 15 ~ 40 mm

B 12

C M H

Machine: Multi needle machines

UMA-89

Bottom elastic waistband with sting

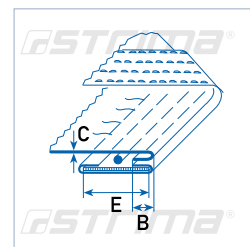

E 15 ~ 40 mm

B 12

C M H

Machine: Multi needle machines

UMA-91

Elasticating hemmer for any kind of fabric and elastic

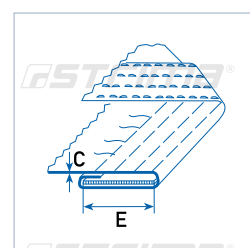

E 25 30 35 40

C L M H

Machine: Multi needle machines

UMA-144

Lap seam folder with piping insertion

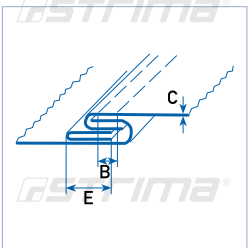

Machine: 2,3 needle feed of the arm machine

B 3/16 1/4

D 15 20 25

C L M

E 7.5 10 12.5

UMA-147

Spring type side seam folder

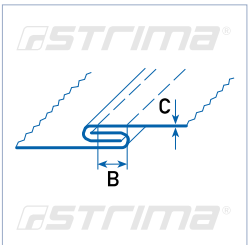

Machine: 2 needle machines

B 3/16 1/4

C L M

UMA-165-L

Bottom elastic waistband folder

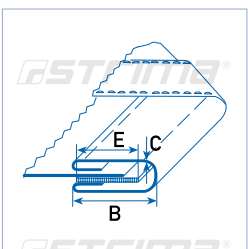

Machine: Multi needle machines

A 80 85 90 95 100 110

B 30 32 35 38 40 42

C L M H

UMA-196

Yoke attachment with piping



A	20	25
B	10	12.5
D	10	
C	L	M

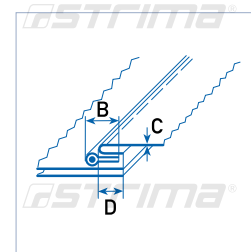

Machine: Standard lockstitch machine

UMA-201

Lap seam folder



B	3/16	1/4
C	L	M

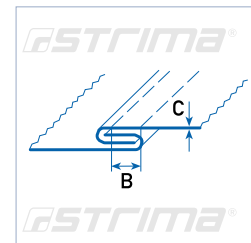

Machine: 2,3 needle feed of the arm machine

UMA-227

Tape guide



A	10	15	20	25	30	35	40
C	L	M	H	XH			

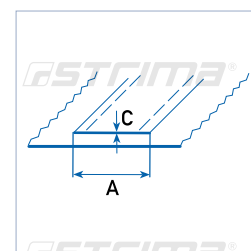

Machine: Flat bed coverstitch, standard lockstitch and 2 needle machines

UMA-230

Tape guide

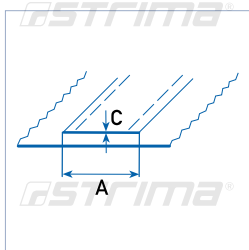

Machine: Standard lockstitch machine



A	5	6.5	8	10	12.5	15
C	L	M				

UMA-232

Lay on foot

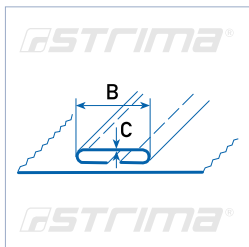

Machine: 2 needle machines



A	16	20	25
B	8	10	12.5
C	L	M	

UMA-233

Multi tape attach folder

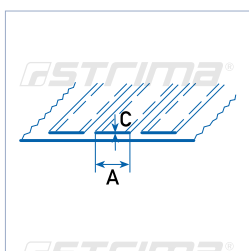

Machine: Multi needle machines



A	10	12
C	L	M

UMA-236

Tape attach folder foot with sting



A 20 25 30

B 10 12.5 15

E 2 3

C L M

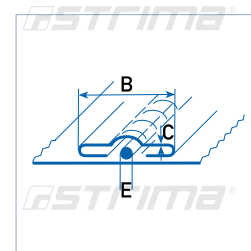

Machine: 2 needle machines

UMA-237

Lay on foot



A 15 18 20

B 4 5 6

C L M

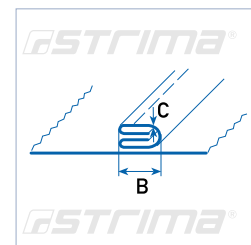

Machine: Standard lockstitch machine

UMA-239

Tape or braid binder



A 15 18 20 25 30

B 7.5 9 10 12.5 15

C L M

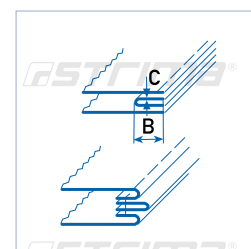
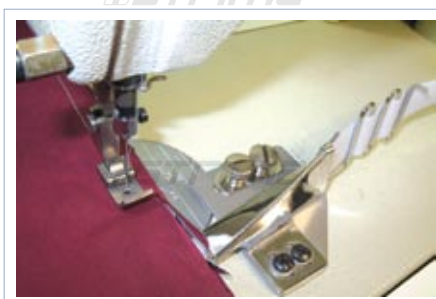

Machine: Standard lockstitch machine

UMA-240

Piping attachment for lockstitch machines

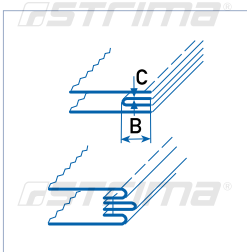

A	20	25	30
B	10	12.5	15
C	L	M	H

Machine: Standard lockstitch machine

UMA-243-B

Adjustable ready - made piping attachment

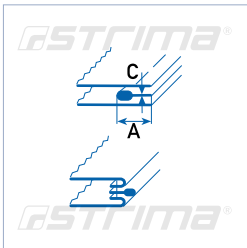

A	6	8	10	12	15
C	L	M			

Machine: Standard lockstitch machine

UMA-244

Cord edge piping attachment

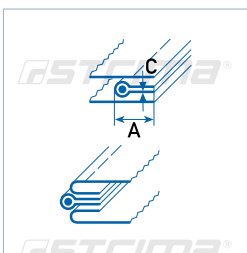

A	20	25	30
B	10	12.5	15
C	L	M	H

Machine: Standard lockstitch machine

UMA-245

Cord edge piping attachment

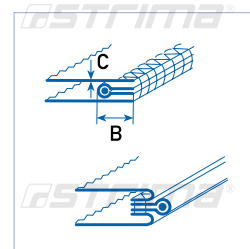

A 20 25 30

B 10 12.5 15

C L M H

Machine: Standard lockstitch machine

<i>BSTRIMA®</i>	<i>BSTRIMA®</i>	<i>BSTRIMA®</i>	<i>BSTRIMA®</i>
<i>BSTRIMA®</i>	<i>BSTRIMA®</i>	<i>BSTRIMA®</i>	<i>BSTRIMA®</i>
<i>BSTRIMA®</i>	<i>BSTRIMA®</i>	<i>BSTRIMA®</i>	<i>BSTRIMA®</i>
<i>BSTRIMA®</i>	<i>BSTRIMA®</i>	<i>BSTRIMA®</i>	<i>BSTRIMA®</i>
<i>BSTRIMA®</i>	<i>BSTRIMA®</i>	<i>BSTRIMA®</i>	<i>BSTRIMA®</i>
<i>BSTRIMA®</i>	<i>BSTRIMA®</i>	<i>BSTRIMA®</i>	<i>BSTRIMA®</i>
<i>BSTRIMA®</i>	<i>BSTRIMA®</i>	<i>BSTRIMA®</i>	<i>BSTRIMA®</i>
<i>BSTRIMA®</i>	<i>BSTRIMA®</i>	<i>BSTRIMA®</i>	<i>BSTRIMA®</i>
<i>BSTRIMA®</i>	<i>BSTRIMA®</i>	<i>BSTRIMA®</i>	<i>BSTRIMA®</i>
<i>BSTRIMA®</i>	<i>BSTRIMA®</i>	<i>BSTRIMA®</i>	<i>BSTRIMA®</i>

Introduction of home textile attachments on product

BSTRIMA® *BSTRIMA®* *BSTRIMA®* *BSTRIMA®*

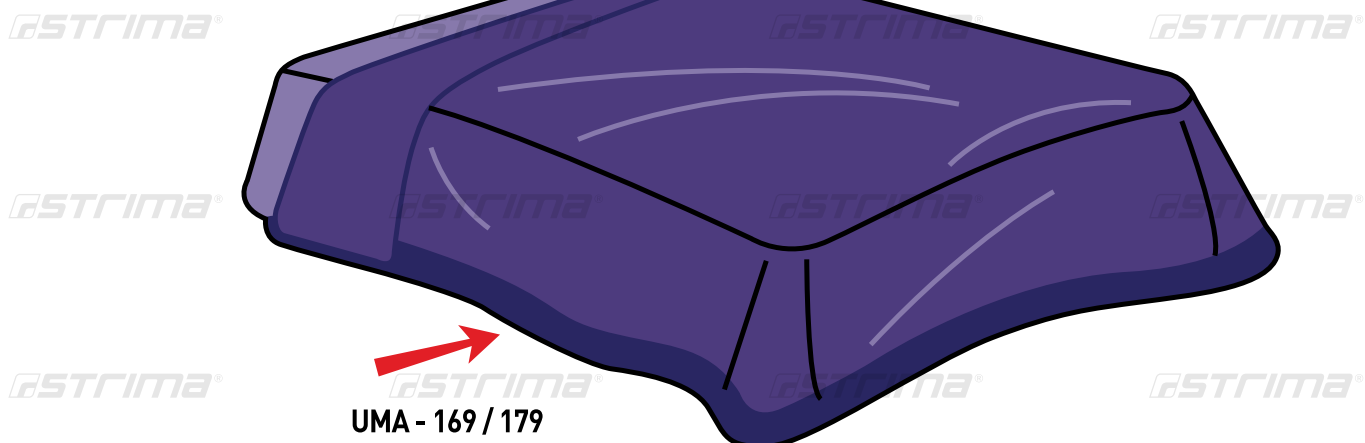
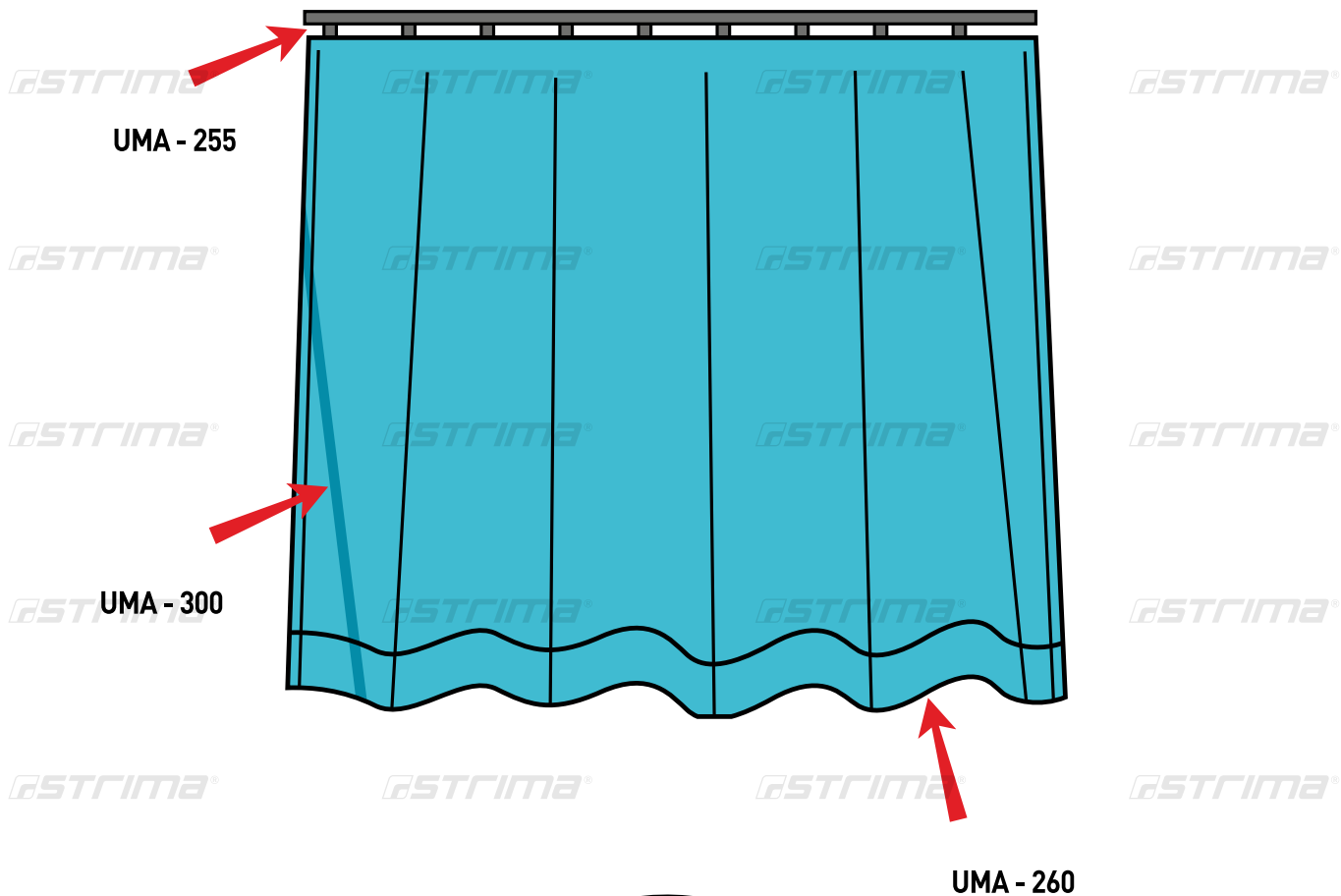

BSTRIMA® *BSTRIMA®* *BSTRIMA®* *BSTRIMA®*

BSTRIMA® *BSTRIMA®* *BSTRIMA®* *BSTRIMA®*

UMA-300

Swing hemmer (large size)



UMA-54 Hemmer for knitted fabric

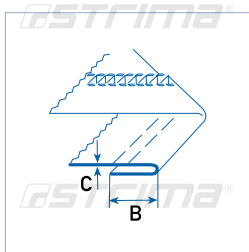

Machine: Standard lockstitch or flat bed coverstitch machine

B	10	15	20	25	30
C	L	M	H		

UMA-55 Hemmer for knitted fabric

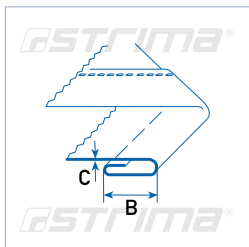

Machine: Standard lockstitch or flat bed coverstitch machine

B	10	15	20	25	30
C	L	M	H		

UMA-86-B Downturn elastic hemmer

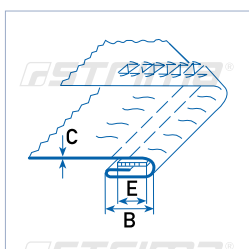

Machine: Flat bed coverstitch machine

B	8	10	12	14	18	20
E	6	8	10	12	16	18
C	L	M	H			

UMA-165-C

Top center plait folder

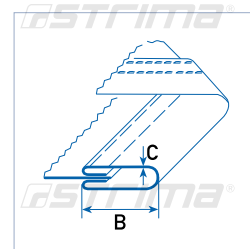
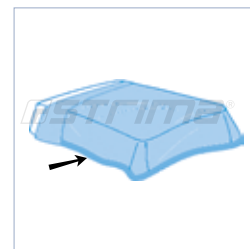

A 60 65 70 80 90 100 110 120 130 150 170 190 210 230

B 20 22 25 30 35 40 42 45 50 60 70 80 90 100

C L M H

Machine: 2 needle machines

UMA-165-K

Top center plait folder

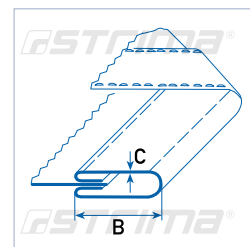
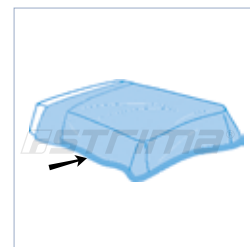

A 70 80 90 100 120 130 150 170 190 210 230

B 25 30 35 40 45 50 60 70 80 90 100

C L M H

Machine: Multi needle machines

UMA-169

Plait folder

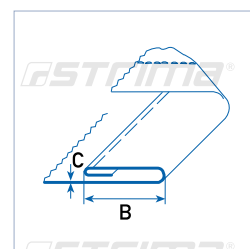

B 10 15 20 25 30 35 40 50

E L M H

Machine: Standard lockstitch machine

UMA-179

Plait folder

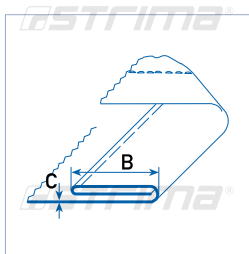

Machine: Standard lockstitch machine

B	10-10	15-15	20-20	25-25	30-30	35-35	40-40	50-50
C	L	M	H					

UMA-225

Strap attachment (curtain)

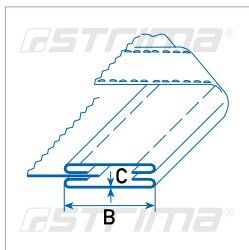

Machine: Waist band machine

A	60	65	70
B	30	35	40
C	L	M	

UMA-227

Tape guide

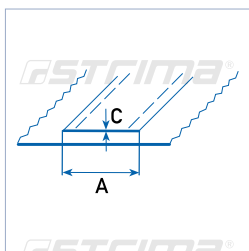

Machine: Standard lockstitch, flat bed coverstitch or 2 needle machines

A	10	15	20	25	30
C	L	M	H		

UMA-229

Zipper attachment (endless zipper)



A 20 25 30

Machine: Standard lockstitch machine

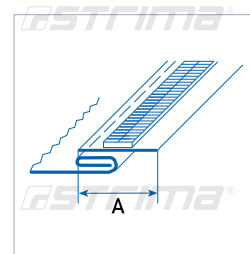

UMA-230

Tape guide



A 5 6,5 8 10 12,5 15
C L M

Machine: Standard lockstitch machine

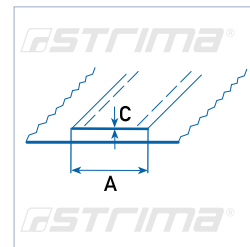

UMA-241

Hemmer with piping



B 60 70 76 80 90 100 D 15 20 25
C L M E 7,5 10 12,5

Machine: Standard lockstitch or 2 needle machines

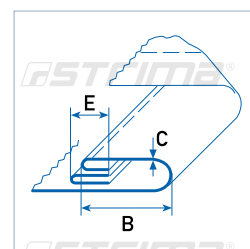

UMA-251

Single upturn feller

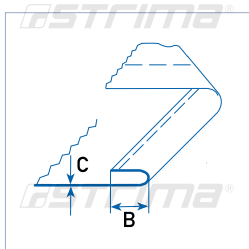
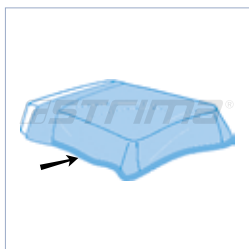

Machine: Standard lockstitch machine

B	6	8	10	15
C	L	M	H	

UMA-253

Single upturn feller

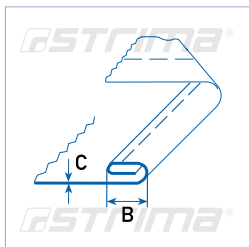

Machine: Standard lockstitch machine

B	5	6	8	10
C	L	M		

UMA-260

Cord hemming complete with foot

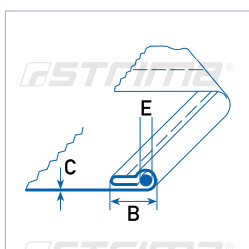
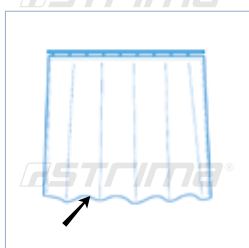

Machine: Standard lockstitch machine

B	10	12	14	16
C	L	M		

UMA-261

Pin tuck attachment



C L M

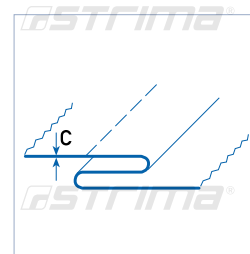
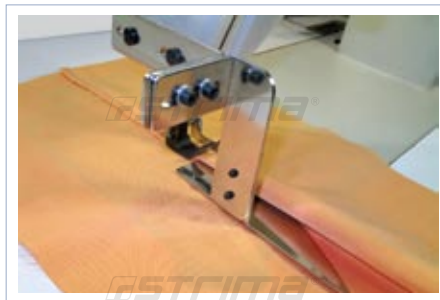

Machine: Standard lockstitch machine

UMA-276

Single fold binder



A 30 35 40 45

B 15 17.5 20 22.5

C M H

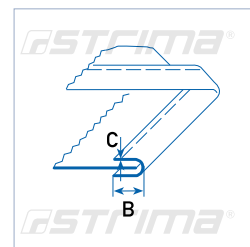

Machine: Single needle cylinder bed walking foot machine

UMA-286

Right angle binder



A 40 45

B 12 13

C M H

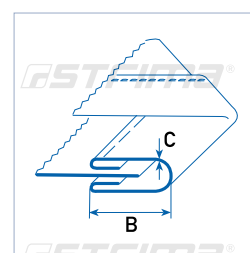

Machine: Walking foot lockstitch machine

UMA-287

Right angle binder

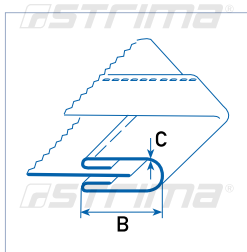
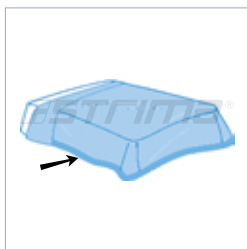

Machine: Walking foot lockstitch machine



A	40	45
B	12	13
C	M	H

UMA-288

Right angle binder

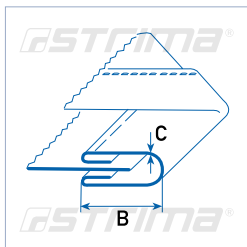
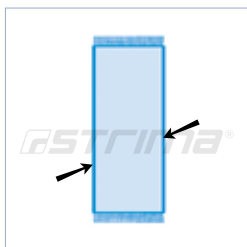

Machine: Walking foot lockstitch machine



A	25	28	30	35	40
B	6	7	8	10	12
C	L	M	H		

UMA-293

Towel waist band folder

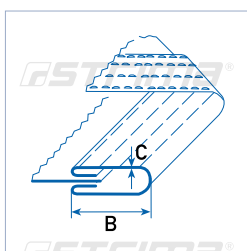

Machine: Walking foot lockstitch machine



A	95	110	120	130
B	35	40	45	50
C	H	XH		

UMA-300

Swing hemmer (large size)

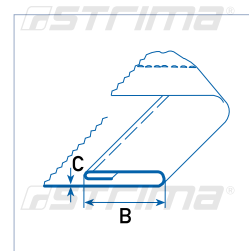
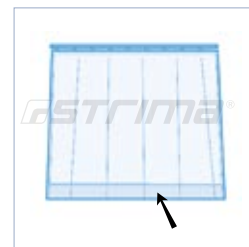

B 50 60 70 80 90 100 130

C L M H

Machine: Standard lockstitch, 2 needle or multi needle machines

UMA-305

Downturn hemmer for towel / right & left

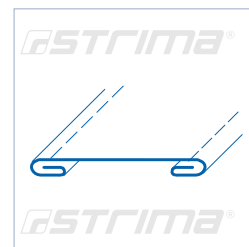
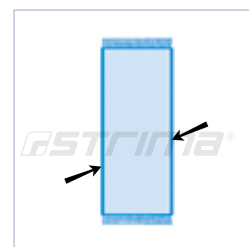

Machine: Special automation machines

UMA-306

Swing hemmer (large size)

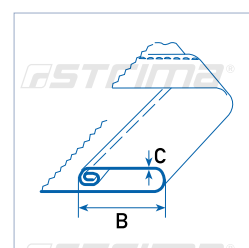

B 50 60 70 80 90 100

C L M

Machine: Standard lockstitch, 2 needle or multi needle machines

UMA-307

Strap attachment (curtain)

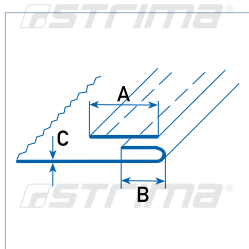

Machine: Multi needle machines

A	20	30	40
B	30	40	50
C	L	M	

UMA-308

Downturn hemmer / right & left

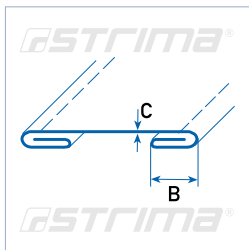

Machine: Special automation machines

B	15	20	25	30	35	40	45	50	55	60	65	70	75	80	85	90	95	100
C	L	M																

UMA-309

Strap attachment (curtain)

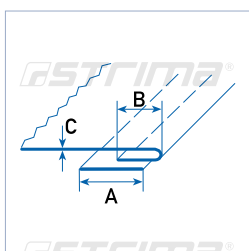

Machine: Multi needle machines

A	20	30	40
B	30	40	50
C	L	M	

UMA-310

Stitched elastic swing hemmer

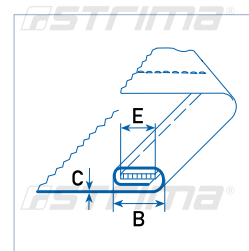

B 10 12

E 8 10

C L M

Machine: Standard lockstitch machine

UMA-313

Waist band folder with piping

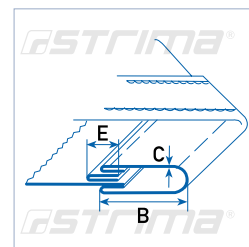
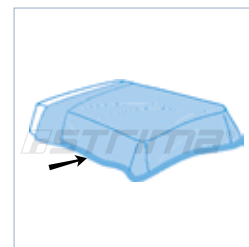

A 70 80 90 100 110 125

B 25 30 35 40 42 50

D 20 25

C L M H

E 10 12.5

Machine: Multi needle machines

UMA-319

Downturn hemmer / right & left (endless zipper)

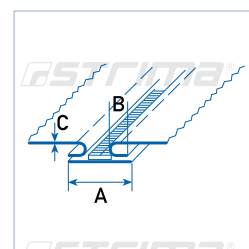

A 12 15 18 20 25 30

B 6 7.5 9 10 12.5 15

C M H

Machine: 2 needle machines

Introduction of packing, leather and upholster attachments on product



UMA - 272 / 275 / 277 / 301 / 304

UMA - 410 / 411

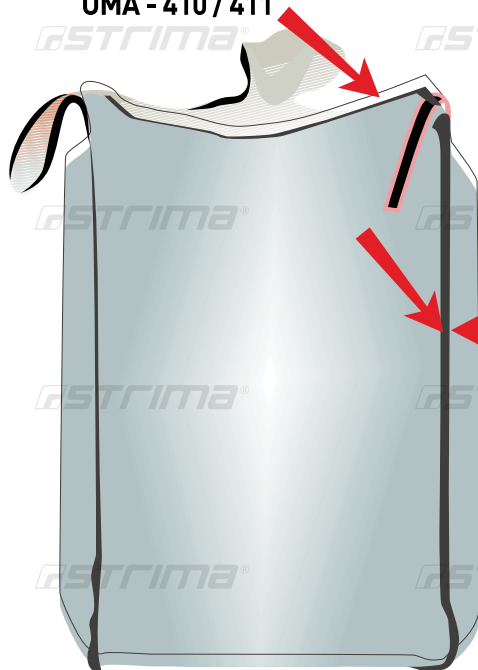

UMA - 412

UMA-276

Single fold binder



276-B

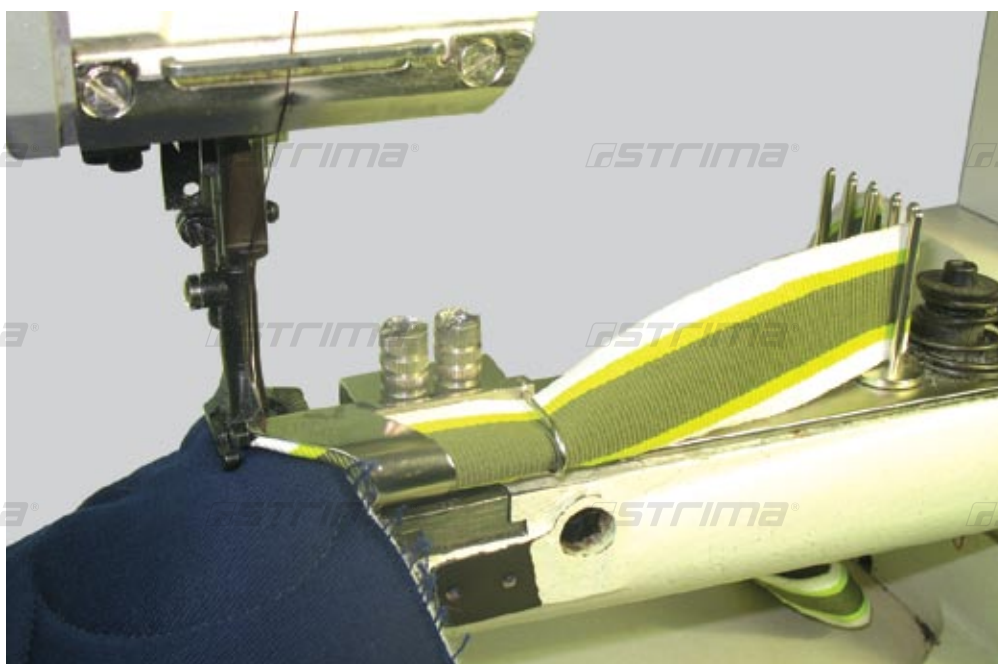

UMA-265

Tape binder

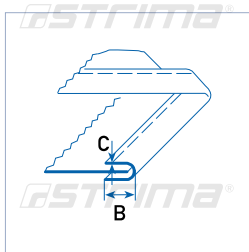

Machine: Single or 2 needle walking foot lockstitch machine



A	12	15	18	20	25	30
B	6	7.5	9	10	12.5	15
C	M	H				

UMA-267

Tape binder for leather

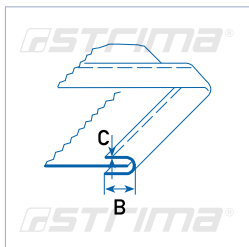
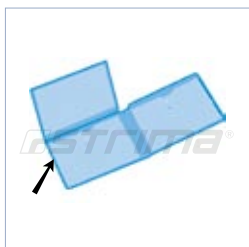

Machine: Single needle cylinder bed walking foot machine



A	12	15	18	20	25	30
B	6	7.5	9	10	12.5	15
C	M	H				

UMA-269

Tape binder for leather

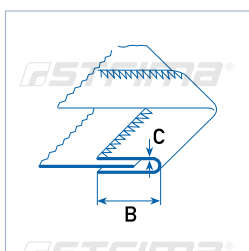

Machine: Standard lockstitch and zig-zag machine



A	12	15	18	20	25	30
B	6	7.5	9	10	12.5	15
C	M	H				

UMA-270

Tape binder



A 18 20 25 30

B 9 10 12.5 15

C M H

Machine: Standard lockstitch machine

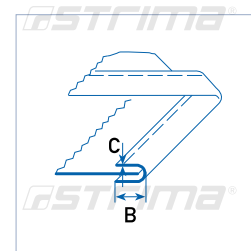
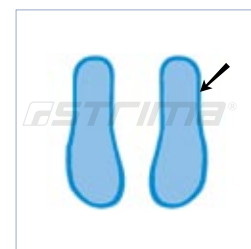

UMA-271

Semi fold binder



A 20 25 30

B 7 9 12

C M H

Machine: Single or 2 needle walking foot lockstitch machine

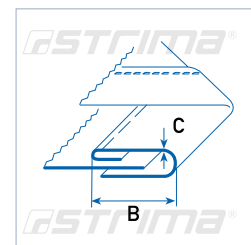

UMA-272

Double fold binder



A 20 25 30 35

B 6 7 8 10

C M H

Machine: Single or 2 needle walking foot lockstitch machine

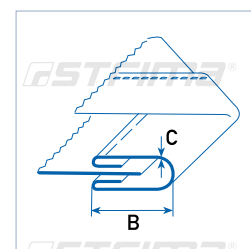

UMA-273

Semi fold binder

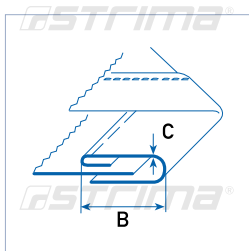
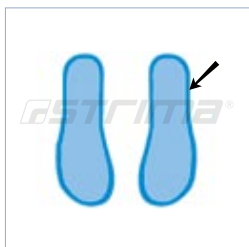

Machine: Single needle cylinder bed walking foot machine

A	20	25	30
B	7	9	12
C	M	H	

UMA-275

Standart single fold shell binding guides

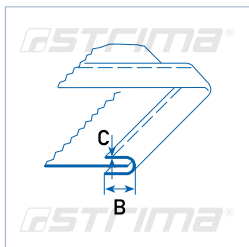
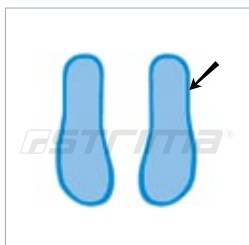

Maszyna: Lamowarka cylindryczna z potrójnym transportem
Machine: Single needle cylinder bed walking foot machine

A	15	18	20	22	25	28
B	7.5	9	10	11	12.5	14
C	L	M	H			

UMA-276

Single fold binder

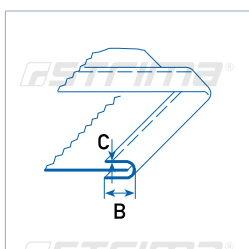

Machine: Single needle cylinder bed walking foot machine

A	30	35	40	45
B	15	17.5	20	22.5
C	L	M	H	

UMA-277

Raw edge tape binder with knife

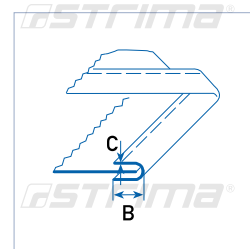

A 20

B 10

C M H

Machine: Single needle cylinder bed walking foot machine

UMA-283

Semi fold binder

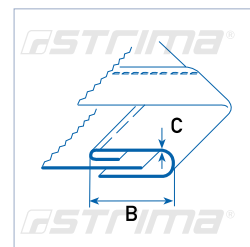

A 20 25 30

B 7 9 12

C M H

Machine: Single needle cylinder bed walking foot machine

UMA-285

Right angle binder

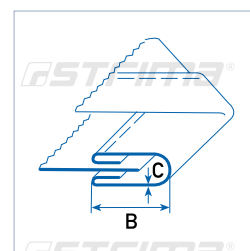

A 25 28 30

B 6 7 8

C M H

Machine: Single needle cylinder bed walking foot machine

UMA-288

Right angle binder

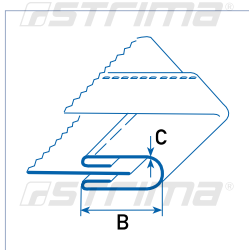
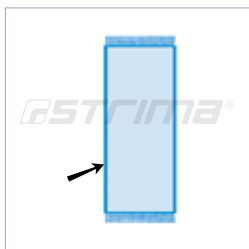

Machine: Single needle cylinder bed walking foot machine



A	25	28	30	35	40
B	6	7	8	10	12
C	L	M	H		

UMA-301

Leather waistband folder with single piping

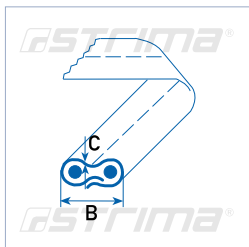

Machine: Single needle walking foot machine



C	M	H	XH
---	---	---	----

UMA-304

Two pieces waistband folder

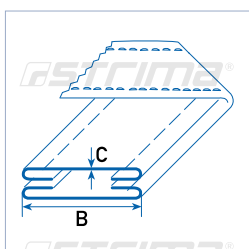

Machine: 2 needle and multi needle machines



C	M	H	XH
---	---	---	----

UMA-410

Tape folder

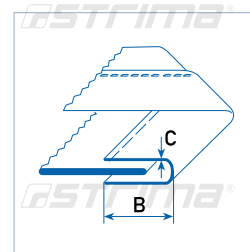

C H

Machine: Special machines

UMA-411

Tape folder

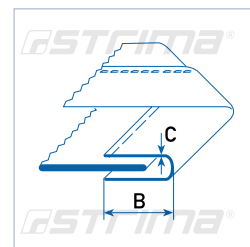

A 70 80

B 35 40

C H

Machine: Special machines

UMA-412

Tape attach folder

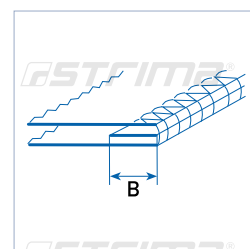

B 20 25 30

C M H

Machine: Special machines

Introduction of hat attachments on product

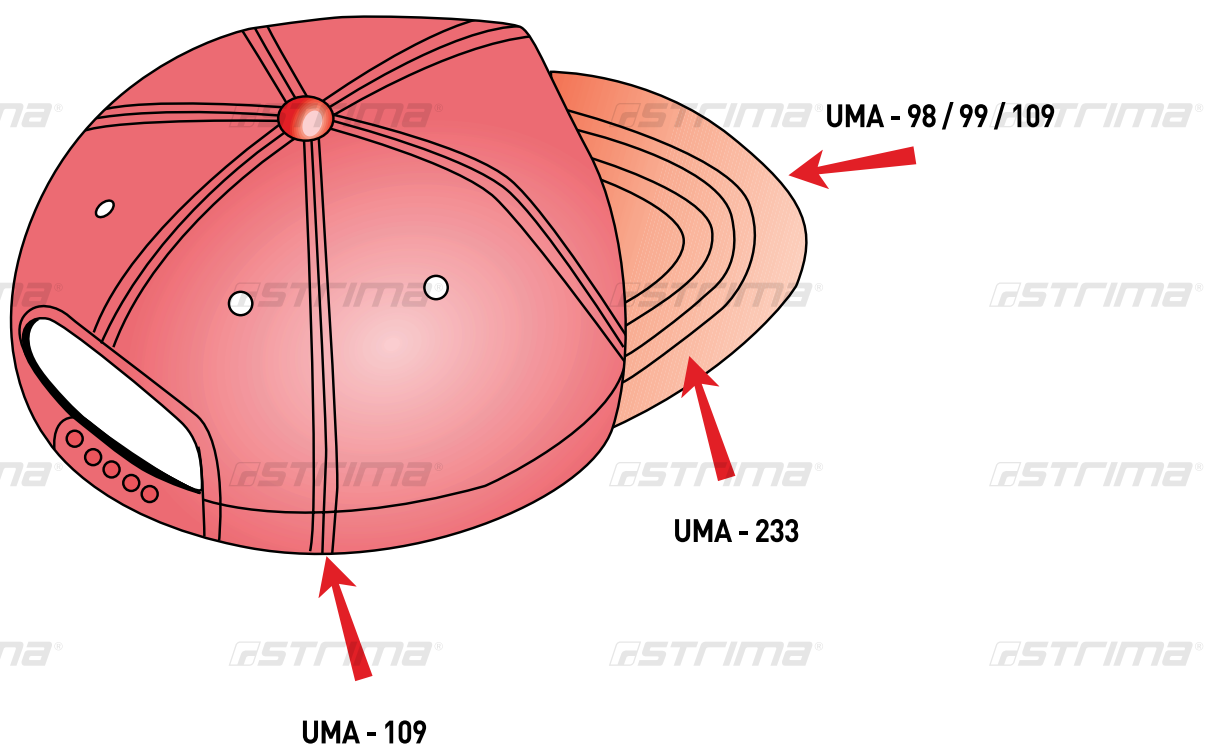



UMA-98

Tape folder

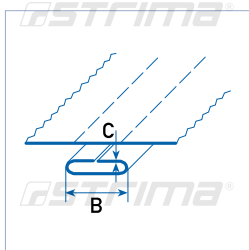

Machine: 2 needle machines

A	20	25
---	----	----

B	10	12.5
---	----	------

C	L	M
---	---	---

UMA-99

Piping folder

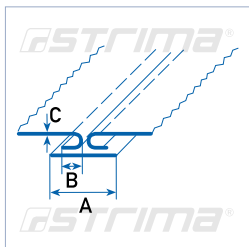
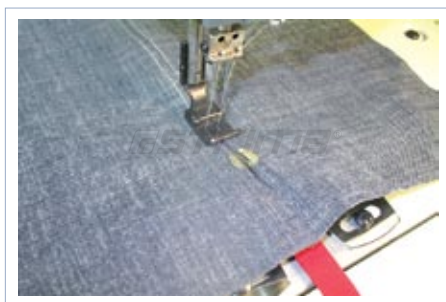

Machine: 2 needle machines

A	18
---	----

B	5
---	---

C	L	M
---	---	---

UMA-107

Tape folder

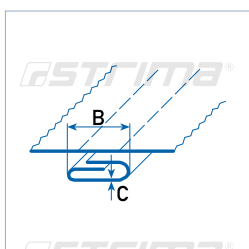

Machine: 2 needle machines

A	16	20	25
---	----	----	----

B	8	10	12.5
---	---	----	------

C	L	M
---	---	---

UMA-109

Tape folder

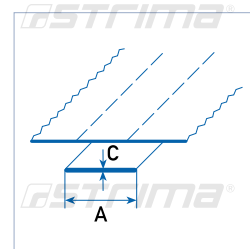

A 8 10 12

C L M

Machine: 2 needle machines

UMA-232

Lay on foot

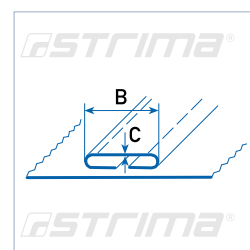

A 16 20 25

B 8 10 12.5

C L M

Machine: 2 needle machines

UMA-233

Multi tape attach folder

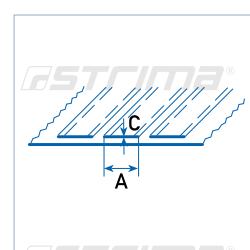

A 10 12

C L M

Machine: Multi needle machines

Introduction of carpet attachments on product

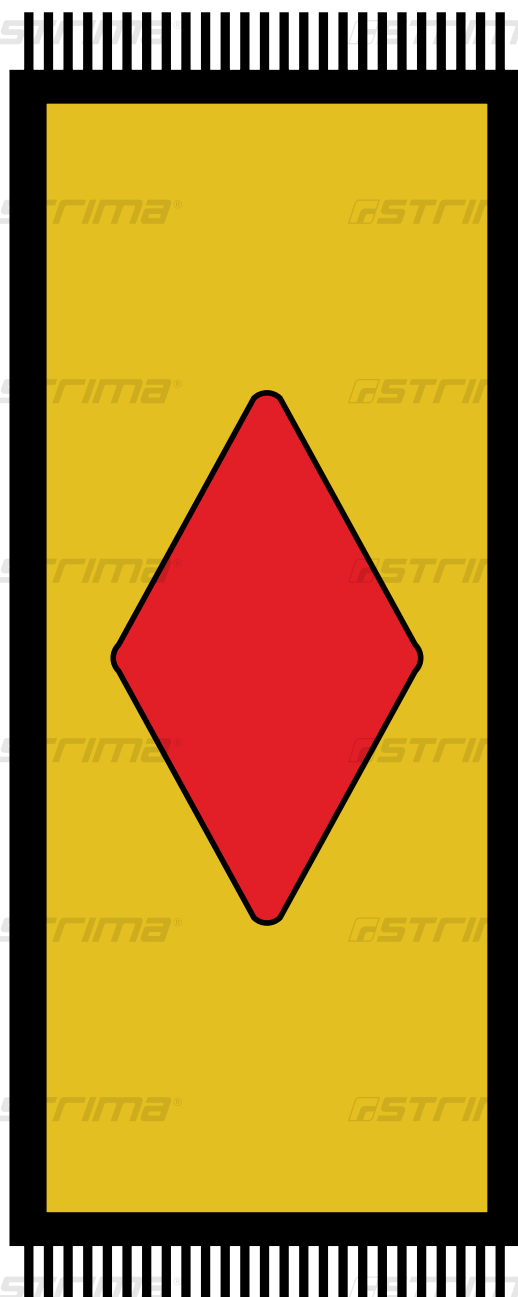

UMA - 400 / 402 / 405

UMA-400

Carpet edge tape folder

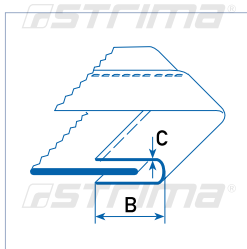
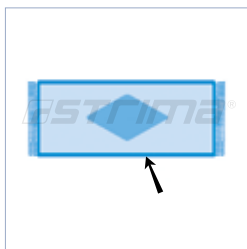

Machine: Zig-zag machine



A 50 55

B 25 27.5

C M

UMA-402

Carpet edge tape binder

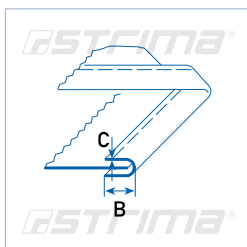
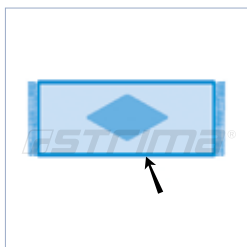

Machine: Zig-zag machine



A 25 28

B 12.5 14

C M

UMA-405

Carpet guide



Machine: Special overlock machine

ACCESSORIES

UMA-TAB02

Tape rack stand



UMA-TAB03

Tape rack



ACCESSORIES

UMA-AB01

Fast bracket



UMA-AB03

Support bracket



UMA-AB21

Bracket for 4-6 needle machines



UMA-AB22

Bracket for 2 needle machines



UMA-AB23

Fast bracket



UMA-AB31

Bracket



Juki
Brother
Siruba
Pegasus

UMA-AB32

Bracket



Brother
Yamato

UMA-AB33

Bracket



Juki
Kingtex

UMA-AB35

Bracket



Juki
Brother
Siruba
Pegasus

UMA-AB36

Bracket



Brother
Yamato

UMA-AB37

Bracket



Juki
Kingtex

UMA-AB41

Bracket for 2-3 needle machines



Juki
Brother

UMA-AB42

Bracket for 2-3 needle machines



Juki
Brother

UMA-AB45

Bracket for waist band machines



UMA-AB51

Swing bracket



UMA-AB52

Fast bracket



UMA-AB53

Bracket for 2 needle machines



UMA-Z082 Back - tack presser

Z082-B for Brother

Z082-J for Juki



Z082-S for Siruba



ACCESSORIES

UMA-TAB01 Tape rack

UMA-TAB02 Tape rack stand



UMA-TAB03 Tape rack

UMA-TAB04 Tension for waist band



SPECIAL PRODUCT SAMPLE

UMA-D-01

Guide



UMA-D-02

Binder



UMA-D-03

Binder



UMA-D-04

Binder



UMA-D-05

Folder



UMA-D-06

Folder



UMA-D-07

Folder



UMA-D-08

Folder



UMA-D-09

Guide



UMA-D-10

Runners



SPECIAL PRODUCT SAMPLE

UMA-D-11

Guide



UMA-D-12

Device for belt-loop sewing machine



UMA-D-13

Guide



UMA-D-14

Guide



UMA-D-15

Plate



UMA-D-16

Hemming foot



UMA-D-17

Hemming foot



UMA-D-18

Foot



UMA-D-19

Pocket clamp



UMA-D-20

Attachment for overlock



SPECIAL PRODUCT SAMPLE

UMA-D-30

Foot



UMA-D-31

Foot



UMA-D-32

Foot



UMA-D-33

Foot



UMA-D-34

Foot



UMA-D-35

Foot



UMA-D-36

Foot



UMA-D-37

Foot



UMA-D-38

Foot



UMA-D-39

Foot



SPECIAL PRODUCT SAMPLE

UMA-D-40

Foot



UMA-D-41

Foot



UMA-D-42

Foot



UMA-D-50

Attachment



UMA-D-51

Attachment



UMA-D-52

Attachment



UMA-D-53

Attachment for Juki and Brother



UMA-D-54

Attachment for Kansai



UMA-D-56

Attachment



SPECIAL PRODUCT SAMPLE

UMA-D-60 Vertical chain trimmer for overlock Brother



UMA-D-61 Horizontal chain trimmer for overlock Brother



UMA-D-62 Vertical chain trimmer for overlock Juki



UMA-D-63 Horizontal chain trimmer for overlock Juki



UMA-D-64 Vertical chain trimmer for overlock Pegasus



UMA-D-65 Horizontal chain trimmer for overlock Pegasus



UMA-D-66 Vertical chain trimmer for overlock Siruba



UMA-D-67 Horizontal chain trimmer for overlock Siruba



UMA-D-68 Thread trimmer



UMA-D-69 Thread trimmer



UMA FITOPEK

F-01 / F-02

Collecting waste and cutting chain system

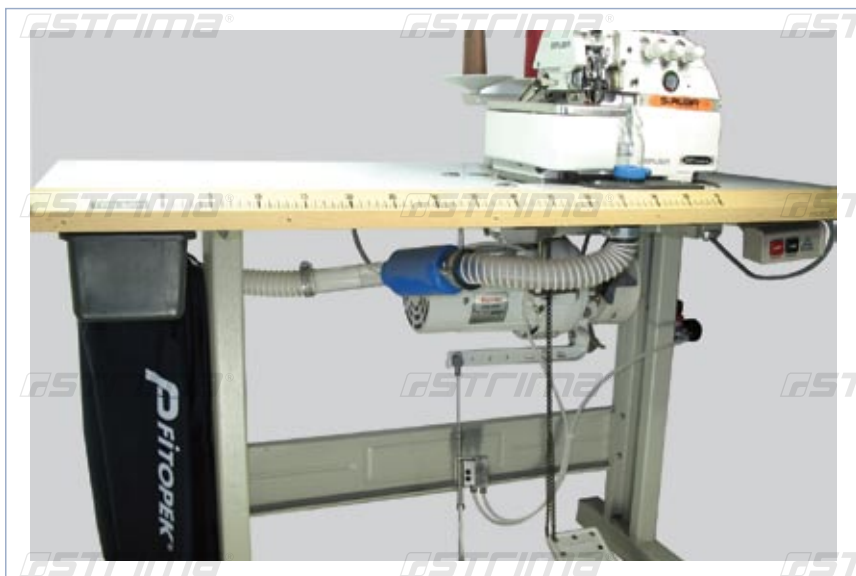

Collecting waste and cutting chain system

Collecting waste system

F-01

F-02



- Accelerates and improves production thanks to cutting chain system
- Reduces consumption of thread through its short cutting
- Waste suction
- Maintains cleanliness of work station
- Lengthens machine life
- Easy to install and user-friendly
- Can be use to every overlock
- When ordering it is important to give concrete machine class

UMA FITOPEK

F-03

Collecting waste system

- Waste suction
- Maintains cleanliness of work station
- Lengthens machine life
- Easy to install and user-friendly
- Machine: lockstitch machine with trimmer



F-04

2-3 needle arm machine cutting chain system

- Accelerates and improves production
- Reduces consumption of thread through it's short cutting
- Easy to install and user-friendly
- Machine: 2-3 needle arm chainstitch machine



UMA FITOPEK

F-05

Pedal up system with air

- Machine: overlock



F-06

Smoothing curled edges system with air

- Machine: overlock



F-07

Lead sewing system

- Machine: overlock



UMA FITOPEK

F-09

Cutting pipe with air

- Machine: multineedle machine and zigzag

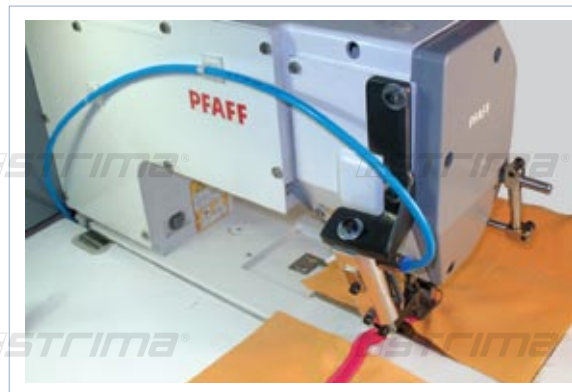

F-10

Electronic cutting cross over

- Machine: flat chainstitch machine



F-11

Hot tape cutting system

- Machine: cylinder-bed machine

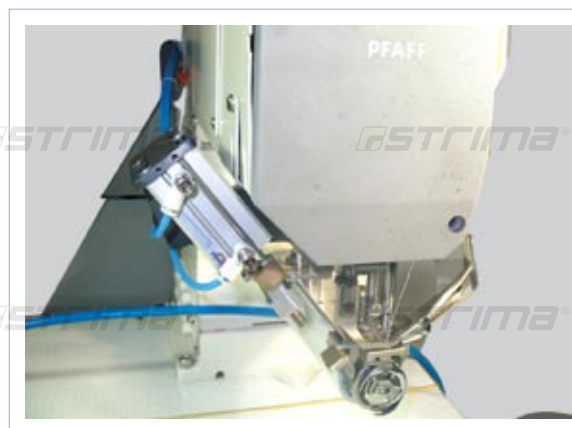

UMA FITOPEK

F-12

T-shirt front placket seam with air



- Machine: 1-needle chainstitch machine



F-13

Sewing shirt yoke with air



- Machine: lockstitch machine

UMA FITOPEK

F-14

Sewing shirrtail system with air



- Machine: lockstitch machine

F-15

Shirt shoulder seam system with air



- Machine: lockstitch machine

UMA REKA

R-03

Pressing machine for general purpose



R-04

Fitting waist band

