

4.1 Linear density

The thickness or diameter of a yarn is one of its most fundamental properties. However, it is not possible to measure the diameter of a yarn in any meaningful way. This is because the diameter of a yarn changes quite markedly as it is compressed. Most methods of measuring the diameter of yarn, apart from optical ones, involve compressing the yarn as part of the measurement process. Therefore the measured diameter changes with the pressure used so that there is a need for agreement on the value of pressure at which the yarn diameter is to be defined. On the other hand optical systems of measuring yarn diameter have the problem of defining where the outer edge of the yarn lies as the surface can be rather fuzzy, having many hairs sticking out from it. Therefore the positioning of the yarn boundaries is subject to operator interpretation. Because of these problems a system of denoting the fineness of a yarn by weighing a known length of it has evolved. This quantity is known as the linear density and it can be measured with a high degree of accuracy if a sufficient length of yarn is used.

There are two systems of linear density designation in use: the direct and the indirect.

4.1.1 Direct system

The direct system of denoting linear density is based on measuring the weight per unit length of a yarn. The main systems in use are:

- Tex – weight in grams of 1000 metres
- Decitex – weight in grams of 10,000 metres
- Denier – weight in grams of 9000 metres

1 tex = 10 decitex.

Tex is the preferred SI unit for linear density but it is not yet in common use throughout the textile industry. Other direct systems can be converted

Table 4.1 Multiplying factors for direct systems of yarn linear density [1]

Yarn number system	Symbolic abbreviation	Unit of mass used	Unit of length used	Multiplying factors yarn number to tex value
Tex	T_t	1 g	1 km	
Denier	T_d	1 g	9,000 m	0.1111
Linen, dry spun, Hemp, jute	T_j	1 lb	14,400 yd (spindle unit)	34.45
Woollen (woollen)	T_{a_w}	1 lb	14,400 yd	34.45

into tex by multiplying by the appropriate factor given in Table 4.1. In the direct system the finer the yarn, the lower is the linear density.

4.1.2 Indirect system

The indirect system is based upon the length per unit weight of a yarn and is usually known as count because it is based on the number of hanks of a certain length which are needed to make up a fixed weight. This is the traditional system of yarn linear density measurement and each branch of the industry has its own system based on the traditional length of hank associated with the locality and the type of yarn manufactured.

The main English ones which are still used every day in the relevant parts of the industry are:

- Yorkshire Skeins Woollen Ny

Count = number of hanks all 256 yards long in 1 pound

- Worsted Count N_{e_w}

Count = number of hanks all 560 yards long in 1 pound

- Cotton Count N_{e_c}

Count = number of hanks all 840 yards long in 1 pound

- Metric count Nm

Count = number of kilometre lengths per kilogram

In the indirect systems the finer the yarn, the higher the count.

One way of measuring count is to measure the linear density using the tex system in the first instance and then to convert the result to the

Table 4.2 Constants for conversion of indirect systems of yarn linear density [1]

Yarn count system	Symbolic abbreviation	Unit of length used	Unit of mass used	Constants for conversion to tex values
Cotton bump yarn	N_B	1 yd	1 lb	31,000
Cotton (English)	N_{e_c}	840 yd (hank)	1 lb	590.5
Linen, wet or dry spun	N_{e_L}	300 yd (lea)	1 lb	1,654
Metric	N_m	1 km	1 kg	1,000
Spun silk	N_s	840 yd	1 lb	590.5
Typp	N_t	1,000 yd	1 lb	496.1
Woollen (Alloa)	N_{a_l}	11,520 yd (spyndle)	24 lb	1,033
Woollen (American cut)	N_{a_c}	300 yd	1 lb	1,654
Woollen (American run)	N_{a_r}	100 yd	1 oz	310
Woollen (Dewsbury)	N_d	1 yd	1 oz	31,000
Woollen (Galashiels)	N_g	300 yd (cut)	24 oz	2,480
Woollen (Hawick)	N_h	300 yd (cut)	26 oz	2,687
Woollen (Irish)	N_{i_w}	1 yd	0.25 oz	7,751
Woollen (West of England)	N_{w_e}	320 yd (snap)	1 lb	1,550
Woollen (Yorkshire)	N_y	256 yd (skein)	1 lb	1,938
Worsted	N_{e_w}	560 yd (hank)	1 lb	885.8

appropriate count system using the appropriate conversion factor K which is given in Table 4.2:

$$\text{Count} = \frac{K}{\text{tex}}$$

4.1.3 Folded yarns

In the traditional count systems a folded yarn is denoted by the count of the singles yarn preceded by a number giving the number of single yarns that make up the folded yarn; for example, 2/24s worsted count implies a

yarn made from two 24s count worsted yarns twisted together; 1/12s cotton count means a single 12s count cotton yarn.

In the tex system there are two possible ways of referring to folded yarns: one is based on the linear density of the constituent yarns and the other is based on the resultant linear density of the whole yarn.

In the first way the tex value of the single yarns is followed by a multiplication sign and then the number of single yarns which go to make up the folded yarn, e.g.

$$80 \text{ tex} \times 2$$

This indicates a yarn made from twisting together two 80 tex yarns. This type of designation is generally used with woollen yarns.

In the second way of numbering folded yarns the linear density of the whole yarn is used. This is known as the resultant linear density of the yarn and is preceded by a capital R to denote resultant. This is then followed by an oblique stroke / and the number of single yarns twisted together, e.g.

$$R 74 \text{ tex}/2$$

This indicates a yarn made from twisting two yarns together which results in a final yarn whose linear density is 74 tex. This type of designation is generally used with worsted yarns.

The two systems are not identical as there is usually some contraction in length when the single yarns are twisted together so making the resultant count slightly higher than would be expected from the count of the single yarns. Therefore in the above example (R 74 tex/2) the linear density of the individual yarns would have been less than 37 tex.

4.1.4 Measuring linear density

Sampling

For lots that contain five cases or less the sample should consist of all the cases. Ten packages are selected at random but in approximately equal numbers from each case.

For lots that consist of more than five cases, five cases should be selected at random and two packages selected at random from each of these cases. In all cases the sampling ends up with ten packages.

Effect of moisture content

Yarns contain a varying amount of moisture depending on the constituent fibres and the moisture content of the atmosphere where they have been stored. The additional moisture can make an appreciable difference to the

weight and hence the linear density of the yarn. Therefore when measuring the linear density of a yarn the moisture content has to be taken into consideration. There are three conventional ways of expressing linear density, each of which has a different way of dealing with the moisture content.

Linear density as received

In this method no allowance is made for the moisture content, the linear density being measured on the yarn as it is. The essence of the method is that a number of skeins are wound on a wrap reel which has a circumference of a convenient length, for example 1 metre. These are then weighed and the linear density calculated from the total length and the weight.

Depending on the linear density and type of fibre used in the construction, yarns can easily be extended by a relatively small load. Therefore when measuring the length of a piece of yarn or when reeling a given length of yarn it is important that the operation is carried out using a standard tension. Because of this factor it is important, for accurate work, that the winding tension used when reeling a hank of yarn on a wrap reel, is correct. The tension on the wrap reel is set by introducing the correct amount of friction into the yarn path. However, the amount of friction introduced is not quantifiable so that the tension has to be set by first making test hanks and then checking their girths on a skein gauge.

The skein gauge which is shown in Fig. 4.1 checks the length of a 50 wrap skein under a standard tension. The test hank is passed round the lower fixed peg and the upper peg which forms one arm of a balance. The load on the other end of the balance is set at $50\text{g} \times$ the nominal tex of the yarn. If the length of the hank is correct the pointer will be opposite the zero mark, any deviation from the correct length is shown directly as a plus or minus percentage. The length of the skein should be within 0.25% of the actual girth of the reel, the reeling tension of the wrap reel being adjusted to achieve this.

Because the yarn on a package may be under tension it is correct practice first to wind a hank from the package of sufficient length for all the tests which are to be carried out. This is then allowed to relax without any tension for 4h before winding the actual test skeins from it.

Linear density at standard testing atmosphere

In this method the skeins of yarn are preconditioned for 4h by drying in an oven at 50°C . They are then conditioned in the standard atmosphere (20°C and 65% RH) for 24h. The reason for preconditioning the yarn is so that the equilibrium moisture content is approached from the same side

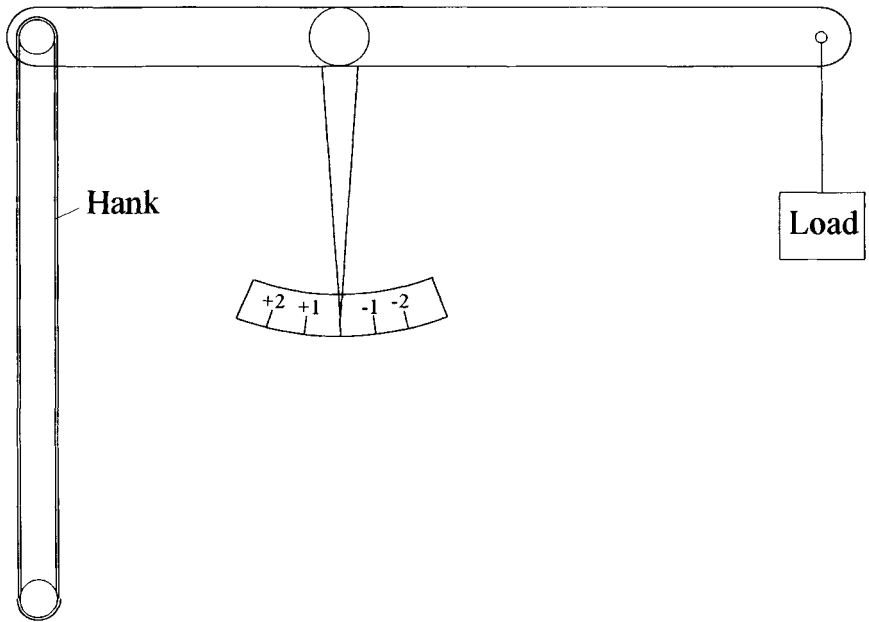

4.1 A skein gauge.

each time, thus avoiding the effects of hysteresis. The reeling of the hanks and calculation of the linear density are then carried out as above.

Linear density at correct condition

This method is more accurate than the previous one as the amount of moisture contained by fibres in equilibrium with the standard atmosphere can vary. In the method the hanks are reeled as above and then dried to oven dry weight (105°C – two consecutive weighings the same) and weighed. The dry weight then has the appropriate standard regain allowance added to it and the linear density is then calculated from this weight

Weight at correct condition

$$= \text{dry weight} \times \frac{(100 + \text{standard regain})}{100}$$

4.1.5 Linear density from a fabric sample

When the linear density of a yarn has to be determined from a sample of fabric, a strip of the fabric is first cut to a known size. A number of threads are then removed from it and their uncrimped length is determined under

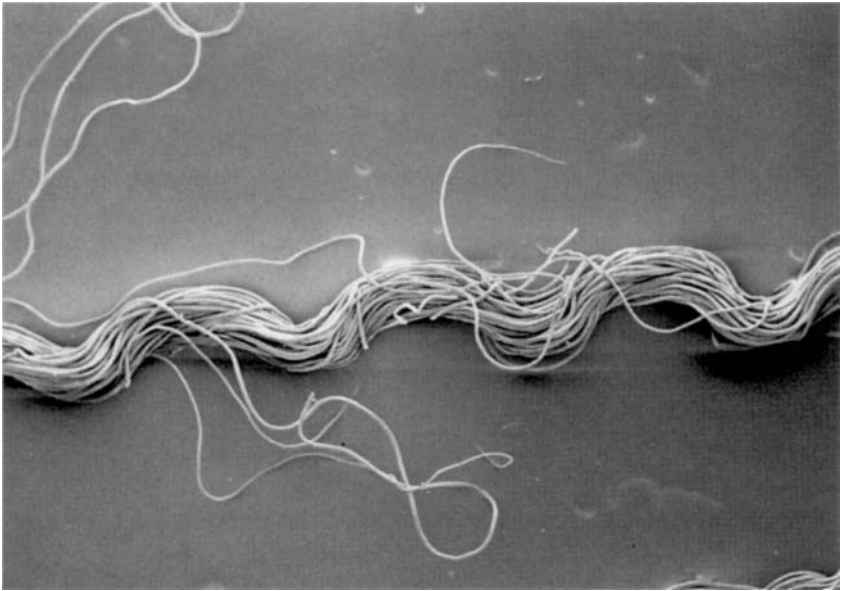

4.2 A portion of yarn removed from a fabric $\times 24$.

a standard tension in a crimp tester. All the threads are weighed together on a sensitive balance and from their total length and total weight the linear density can be calculated.

Yarn from a finished fabric may have had a resin or other type of finish applied to it so that its weight is greater than that of the original yarn. Alternatively it may have lost fibres during the finishing process so that its weight may be lower than that of the original yarn. For these reasons the linear densities of yarn from finished fabrics can only represent an estimate of the linear density of the yarn used to construct the fabric.

Shirley crimp tester

When yarn is removed from a fabric it is no longer straight but it is set into the path that it took in the fabric as shown in Fig. 4.2. This distortion is known as crimp and before the linear density of the yarn can be determined the crimp must be removed and the extended length measured.

The crimp tester is a device for measuring the crimp-free length of a piece of yarn removed from a fabric. The length of the yarn is measured when it is under a standard tension whose value is given in Table 4.3. The instrument is shown diagrammatically in Fig. 4.3 and consists of two clamps, one of which can be slid along a scale and the other which is pivoted so as to apply tension to the yarn. The sample of yarn removed from the fabric is

Table 4.3 Yarn tensions for the crimp tester [2]

Yarn type	Linear density	Tension (cN)
Woollen and worsted	15 to 60 tex 61 to 300 tex	$(0.2 \times \text{tex}) + 4$ $(0.07 \times \text{tex}) + 12$
Cotton	7 tex or finer coarser than 7 tex	$0.75 \times \text{tex}$ $(0.2 \times \text{tex}) + 4$
All man-made continuous filament yarn	All	$0.5 \times \text{tex}$

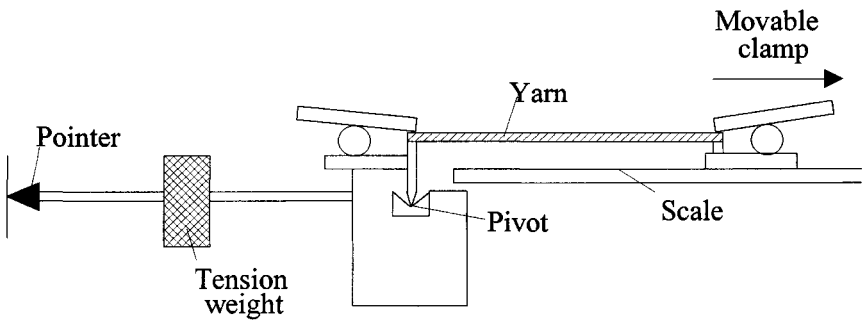

4.3 The Shirley crimp tester.

placed in the clamps with each end a set distance into the clamp. This is because the length of yarn in the clamps has to be allowed for in the measurement. The right hand clamp can be moved along the scale and it has an engraved line on it at which point the extended yarn length can be read. The left hand clamp is balanced on a pivot with a pointer arm attached. On the pointer arm is a weight which can be moved along the arm to change the yarn tension, the set tension being indicated on a scale behind it. At zero tension the left hand clamp assembly is balanced and the pointer arm lines up against a fixed mark. As the weight is moved along the arm the clamp tries to rotate around the pivot, so applying a tension to the yarn.

When a measurement is being made the movable clamp is slid along the scale until the pointer is brought opposite the fixed mark. At this point the tension in the yarn is then the value which was set on the scale. The length of the yarn can then be read off against the engraved line.

The crimp, which is the difference between the extended length and the length of the yarn in the fabric, is defined as:

$$\text{Percentage crimp} = \frac{(L_1 + L_0)}{L_0} \times 100$$

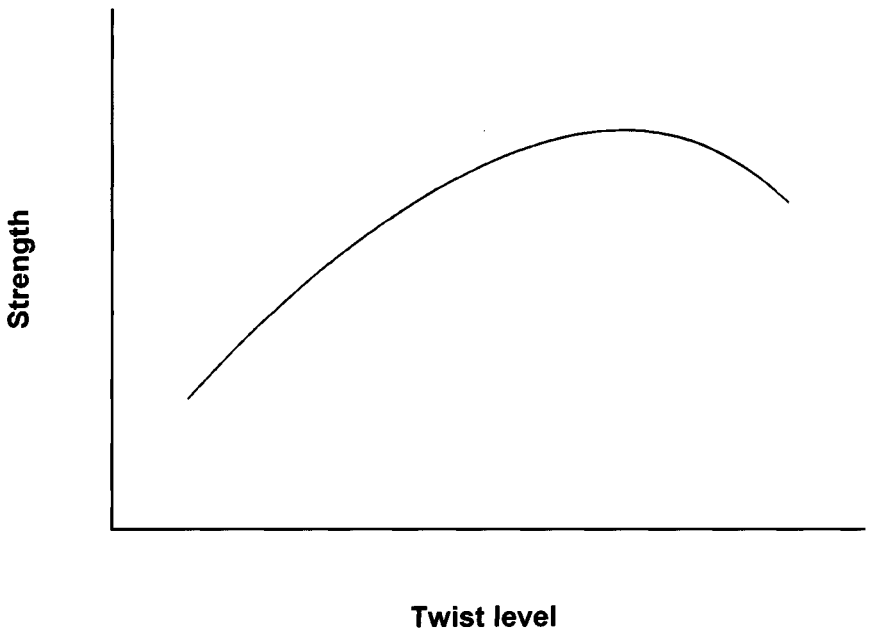

4.4 The effect of twist level on strength, staple fibre yarn.

where L_0 = distance between ends of the yarn as it lies in the fabric
 L_1 = straightened length of yarn

4.2 Twist

Twist is primarily introduced into a staple yarn in order to hold the constituent fibres together, thus giving strength to the yarn. The effects of the twist are twofold: as the twist increases, the lateral force holding the fibres together is increased so that more of the fibres can contribute to the overall strength of the yarn. Secondly as the twist increases, the angle that the fibres make with the yarn axis increases, so preventing them from developing their maximum strength which occurs when they are oriented in the direction of the applied force. The overall result is that there is a point as twist is increased where the strength of the yarn reaches a maximum value, after which the strength is reduced as the twist is increased still further; this is shown diagrammatically in Fig. 4.4. The twist value required to give the maximum strength to a yarn is generally higher than the twist values in normal use since increased twist also has an effect on other important yarn properties.

A small amount of twist is used in continuous filament yarns to keep the filaments together, but the effect of increasing twist is to reduce the strength

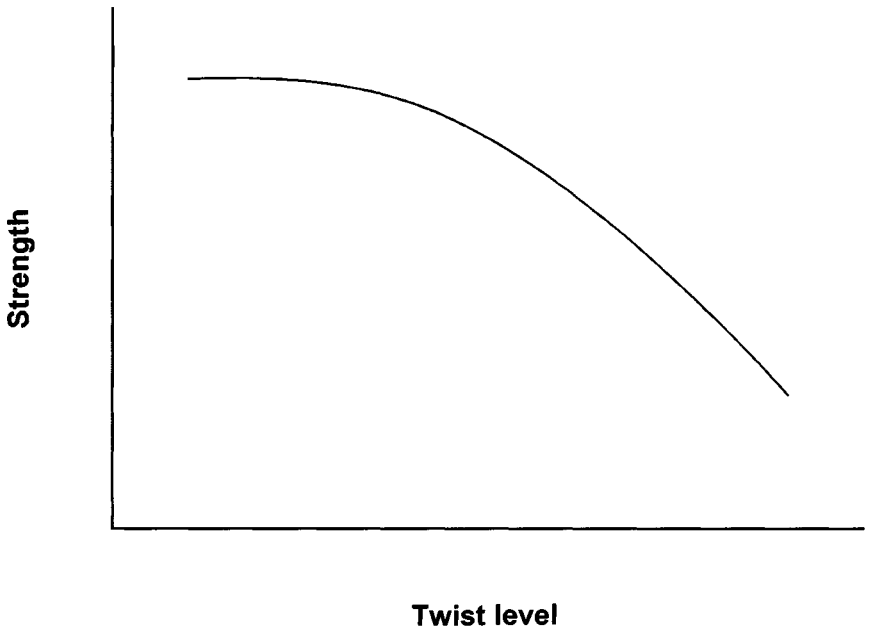

4.5 The effect of twist level on strength, continuous filament yarn.

of the yarn below its maximum possible value. The theoretical maximum strength of a continuous filament yarn would be expected to be realised when the filaments were aligned parallel to the yarn axis. However, because of the variability of individual filament strengths the initial effect of twist is to increase the strength of the yarn because of the support given to the weaker filaments. The effect of twist on a continuous filament yarn is shown diagrammatically in Fig. 4.5. The consequence of the effect of twist in reducing the strength of a yarn below its theoretical maximum is that a filament yarn will be stronger than the equivalent staple fibre yarn as a comparatively large amount of twist is always needed in a staple yarn.

The level of twist has other effects on yarn and fabric properties which may override the need for increased strength, including the following:

- 1 **Handle.** As the twist level in a yarn is increased it becomes more compact because the fibres in it are held more tightly together, so giving a harder feel to the yarn. Furthermore the covering power of the yarn is reduced because of the decrease in the diameter of the yarn. A fabric made from a high-twist yarn will therefore feel harder and will also be thinner. Conversely a fabric produced from a low-twist yarn will have a soft handle which is often a desirable property. However, a reduction in twist level will make the yarn weaker and will also allow the constituent

fibres to be more easily removed with consequences for the pilling and abrasion properties of the fabric.

- 2 **Moisture absorption.** A high level of twist in a yarn holds the fibres together and hence restricts the access of water to the yarn interior. Therefore such a yarn would be used where a high degree of water repellency is required, for example in a gabardine fabric. A low-twist yarn will absorb water more readily than a high-twist one so would be used in those applications where absorbency is required.
- 3 **Wearing properties.** The level of twist has effects on two aspects of wear: abrasion and pilling. A high level of twist helps to resist abrasion as the fibres cannot easily be pulled out of the yarn. The same effect also helps to prevent pilling which occurs when fibres are pulled out of the fabric construction and rolled into little balls on the surface.
- 4 **Aesthetic effects.** The level of twist in a yarn alters its appearance both by changing the thickness and also by altering the light-reflecting properties owing to the change in angle of the fibres. This means that subtle patterns can be produced in a fabric by using similar yarns but with different twist levels. For instance a shadow stripe can be produced by weaving alternate bands of S and Z twist yarns (see Fig. 4.7 below) in the warp. The level of twist can also be used to enhance or subdue a twill effect, depending on whether the fibres in the yarns line up with the twill direction or against it depending on their twist direction.
- 5 **Faults.** Because the level of twist in a yarn can change its diameter and other properties such as absorption, variation in twist levels in what is nominally the same yarn can change the appearance of a fabric, so giving rise to complaints.

4.2.1 Level of twist

Twist is usually expressed as the number of turns per unit length such as turns per metre or turns per inch. However, the ideal amount of twist varies with the yarn thickness: the thinner the yarn, the greater is the amount of twist that has to be inserted to give the same effect. The factor that determines the effectiveness of the twist is the angle that the fibres make with the yarn axis. In yarns of different linear densities the same angle is produced by different amounts of twist but it leads to the same twist-dependent properties in the yarns. Figure 4.6 shows diagrammatically a fibre taking one full turn of twist in a length of yarn L . The fibre makes an angle θ with the yarn axis. For a given length of yarn the angle is governed by the yarn diameter D :

$$\tan\theta = \frac{\pi D}{L}$$

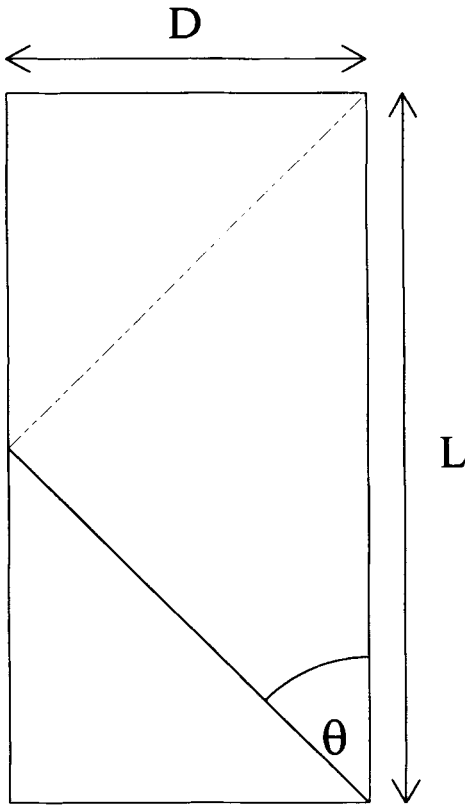

4.6 The twist angle.

The greater the diameter of the yarn, the larger is the angle produced by one turn of twist. As $1/L$ is equivalent to turns per unit length then:

$$\tan\theta \propto D \times \text{turns/unit length}$$

In the indirect system for measuring linear density the diameter is proportional to $1/\sqrt{\text{count}}$. Therefore

$$\tan\theta \propto \frac{\text{turns/unit length}}{\sqrt{\text{count}}}$$

A twist factor is defined using this relationship:

$$K = \frac{\text{turns/unit length}}{\sqrt{\text{count}}}$$

where K is the twist factor.

The numerical value of the twist factor differs with each count system. In the case of direct systems of linear density measurement such as tex:

$$K = \text{turns per metre} \times \sqrt{\text{count}}$$

Typical cotton yarns have twist factors ranging from 3.0 to 8.0 when the measurements are in turns per inch and cotton count (the equivalent values are 29 to 77 when the twist is measured in turns per cm and the linear density in tex). Worsted yarns have twist factors ranging from 1.4 to 2.5 when the twist is measured in turns per inch and the linear density in worsted count (equivalent tex values are 17–29).

A cotton yarn that has a twist factor of 3 will feel soft and docile, whereas a yarn that has a twist factor of 8 will feel hard and lively. A lively yarn is one that twists itself together when it is allowed to hang freely in a loop. Crepe yarns use high twist factors (5.5–8.0 cotton count) to give characteristic decorative effects. A fabric made from such yarns is first wetted and then dried without any constraint. This allows the yarns to curl, producing the characteristic uneven crepe effect.

The twist in a yarn is not usually distributed uniformly along its length. There is a relationship [3] between the twist and the thickness of a yarn which takes the form:

$$\text{Twist} \times \text{mass per unit length} = \text{constant}$$

that is, the twist tends to run into the thin places in a yarn. This means that the twist level will vary along the yarn inversely with the linear density. An uneven yarn will therefore have a twist variability of the same magnitude. Because of this variation it is suggested that the twist level should be determined at fixed intervals along a yarn such as every metre.

4.2.2 Measuring twist

Direction of twist

Twist is conveniently denoted as either S or Z as shown in Fig. 4.7.

Withdrawal of yarn from package

Withdrawal of yarn over the end of a package adds twist to a yarn, whereas withdrawal from the side of the package does not. The British Standard for twist measurement [4] lays down that the yarn should be withdrawn from the package in the manner in which it would be normally used in the next stage of processing. This means that the measured twist may not be the same as the inserted twist.

Twist in yarns, direct counting method

This is the simplest method of twist measurement. It is also the only method recognised as a British Standard [4]; the US standard [5] is similar. The

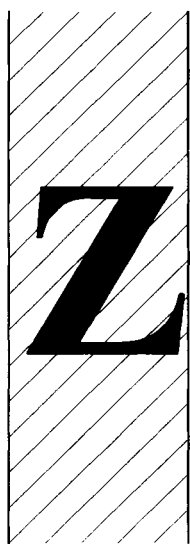
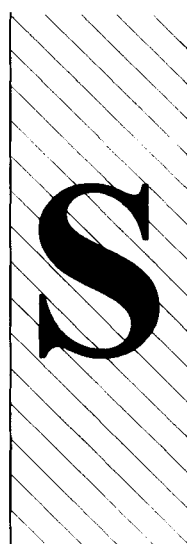
**Z Twist****S Twist**

4.7 S and Z twist.

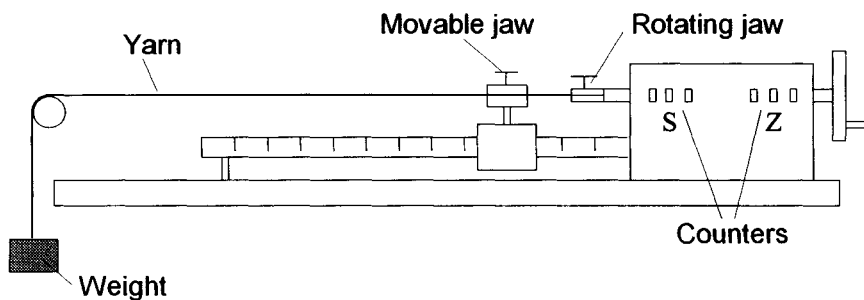

4.8 A simple twist tester.

essence of the method is to unwind the twist in a yarn until the fibres are parallel to the yarn axis and to count how many turns are required to do this. A suitable instrument, an example of which is shown in Fig. 4.8, has two jaws at a set distance apart. One of the jaws is fixed and the other is capable of being rotated. The rotating jaw has a counter attached to it to number the whole turns and fractions of a turn. Before starting any tests the samples should have been conditioned in the standard testing atmosphere.

Testing is started at least one metre from the open end of the yarn as the open end of the yarn is free to untwist so that the level of twist may be lower in that region. As the yarn is being clamped in the instrument it must be kept under a standard tension (0.5 cN/tex) as the length of the yarn will be altered by too high or too low a tension. The twist is removed by turning the rotatable clamp until it is possible to insert a needle between the individual fibres at the non-rotatable clamp end and to traverse the needle across to the rotatable clamp. The use of a magnifying lens may be required in order to test fine yarns.

The twist direction and the mean turns per centimetre or per metre are reported.

Number of tests

- 1 Single spun yarns. A minimum of 50 tests should be made. The specimen length between clamps must not exceed the average staple length of the yarn. For cotton yarns 10 or 25 mm between the clamps is suitable, for woollen or worsted yarns 25 or 50 mm should be used.
- 2 Folded and cabled yarns and single continuous filament yarns. A minimum of 20 tests should be carried out with a specimen length of not less than 250 mm.

Continuous twist tester

This apparatus is designed to reduce the amount of handling needed on consecutive twist tests and to speed up the testing process. Yarn passes through the rotating jaw end and is wound up on a rotating drum as it is moved on. Twist is assessed by the same principle as on other twist testers but after removing the twist it is put back into the yarn by rotating the counter back to zero. The rotating clamp is opened and its jaws moved forward to meet the fixed clamp; the jaws are then clamped on the yarn. The fixed clamp is opened and moving jaws are returned to the starting position, taking a new length of yarn with them; the drum takes up the slack in the yarn.

Untwist-twist method

This method is based on the fact that yarns contract in length as the level of twist is increased. Therefore if the twist is subsequently removed, the yarn will increase in length reaching a maximum when all the twist is removed. The method uses a piece of equipment such as that shown in Fig. 4.9 in which the end of the yarn distant from the counter is attached to a pointer which is capable of magnifying its changes in length. At the start of the test the yarn is placed under a suitable tension, either by a clip-on

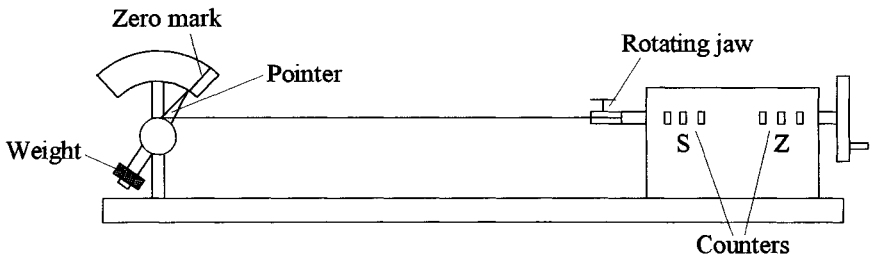

4.9 A tension twist tester.

weight or by a weighted arm as shown. The test procedure is to untwist the yarn until all its twist has been removed and then to continue twisting the yarn in the same direction, until it returns to its original length. The basis of the method is the assumption that the amount of twist put in is equal to the twist that has been removed. However, this is not necessarily the case. For woollen yarns the method may give results up to 20% below the true value, whereas for worsted yarns the results may be 15% higher owing to fibre slippage [6]. One source of error in the method is that at the point of total twist removal the fibres in the yarn are unsupported so that any tension in the yarn may cause the fibres to slip past one another, so increasing the length of the yarn. The difference in length if unnoticed will cause an error in the measurement of turns per unit length. Another source of error is the fact that with some yarns, when the twist is removed, the amount of twist to bring it back to the same length is not equal to the twist taken out.

Because of these problems the method is not recommended for determining the actual twist of a yarn but only for use as a production control method. There is a US standard for this method [7] but it warns that the measured values are only an approximation of the true twist. It suggests that 16 samples are tested using a gauge length of 250 or 125 mm. However, the method is easy to use and has less operator variability than the standard method so that it is often used for measuring the twist in single yarns.

Multiple untwist–twist method

The straightforward untwist–twist method is subject to a variable error owing to the fact that the number of turns to return the yarn to its original length is not the same as the number of turns to take the twist out. This is mainly because when the yarn is spun some of the distortion becomes permanently set into the fibres so that when the twist is removed the yarn is not as straight as it should be. This is particularly a problem in yarns made from wool fibres, especially those that have been deliberately treated in order to set the twist.

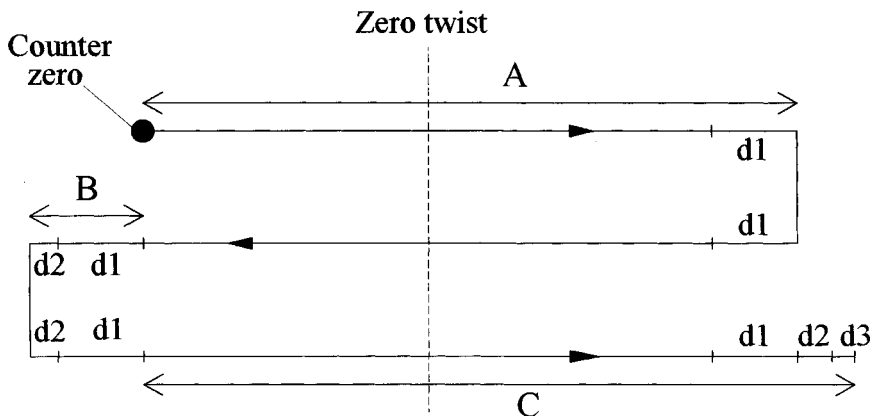

4.10 The multiple untwist—twist method.

The multiple untwist—twist method aims to overcome these problems by repeating the untwisting and twisting action which causes the error due to this source to be progressively reduced. In the test, shown diagrammatically in Fig. 4.10, the yarn is untwisted and retwisted back to its original length as in the normal test and the number of turns A noted. The value A contains an unknown error d_1 . Without the counter being zeroed, the direction of turning is reversed and the yarn untwisted and twisted back to its original length. This ought to bring the yarn back to its original condition, however owing to the errors the counter will show a small number of turns instead of zero. This reading is taken to be B and is due to the errors d_1 and d_2 . By untwisting and retwisting a third time a further reading C is obtained which contains the errors d_1 , d_2 and d_3 as shown. Combining the readings A , B and C gives:

$$A - 2B + C = 4x$$

where x is the number of turns in the length of yarn tested.

The method relies on the errors d_1 , d_2 and d_3 becoming progressively smaller so that the remaining error in the above equation is the difference between d_2 and d_3 and can be ignored. It is possible to carry out further untwisting and twisting in the same manner to reduce the error even further.

Automatic twist tester

An automatic twist tester is produced (Zweigle D302) which takes the tedium out of the large number of tests required for determining twist. This necessarily depends on untwist—twist type methods for determining twist levels as it cannot detect fibre straightening automatically.

Take-up twist tester

Take-up is the difference between the twisted and untwisted length of a yarn. Twist testers are available with a movable non-rotating jaw which is slid away from the rotating jaw to take up the slack as the twist is removed. This allows the length difference to be measured.

Folded Yarns

Folded or plied yarns have two levels of twist in them. Firstly there is the twist in the individual strands making up the ply and secondly there is the twist that holds the individual plies together. If the twist in the single strands is required the yarns can be analysed by first removing the folding twist and then cutting out individual yarns, leaving the one strand which is to be measured in the twist tester.

4.4 Hairiness

Yarn hairiness is in most circumstances an undesirable property, giving rise to problems in fabric production. Therefore it is important to be able to measure it in order to control it. However, it is not possible to represent hairiness with a single parameter because the number of hairs and the length of hairs both vary independently. For example Fig. 4.18 shows a relatively smooth yarn and Fig. 4.19 a much hairier yarn. Theoretically a yarn may have a small number of long hairs or a large number of short hairs or indeed any combination in between. The problem is then which combination should be given a higher hairiness rating.

It has been found that the number of hairs of different lengths protruding from a yarn is distributed according to an exponential law [12]. That is there are far more short hairs than long ones and the number of hairs falls off exponentially as the hair length increases. It is considered that there are two different exponential mechanisms in operation, one for hairs above 3mm long and one for those below; this is shown in Fig. 4.20 where the two parts of the plot of the log of the number of hairs against hair length can be approximated by a straight line. The hairiness index devised by [13] assumes a straight line on the plot of the log of the number of hairs against hair length. The number of hairs exceeding 3mm in length as a percentage of the total number of hairs is found to be

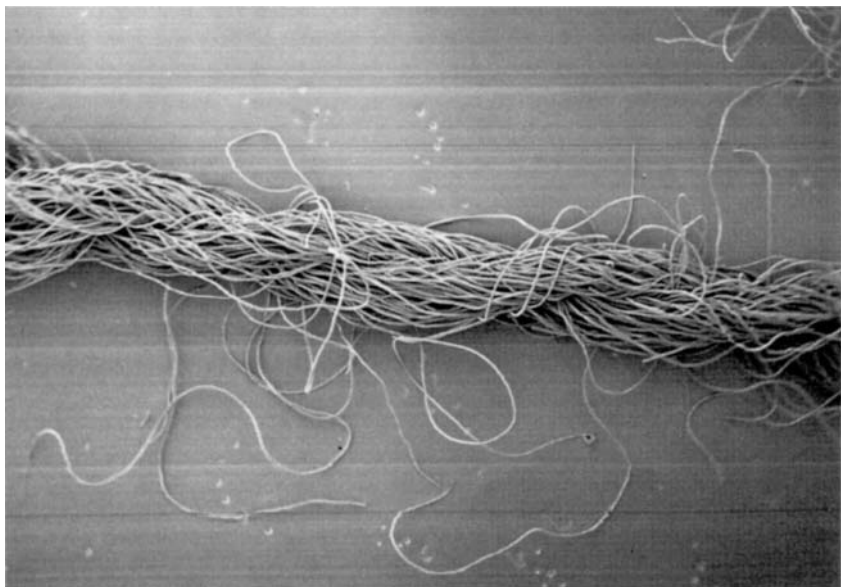

4.18 A yarn with a low number of hairs $\times 13$.

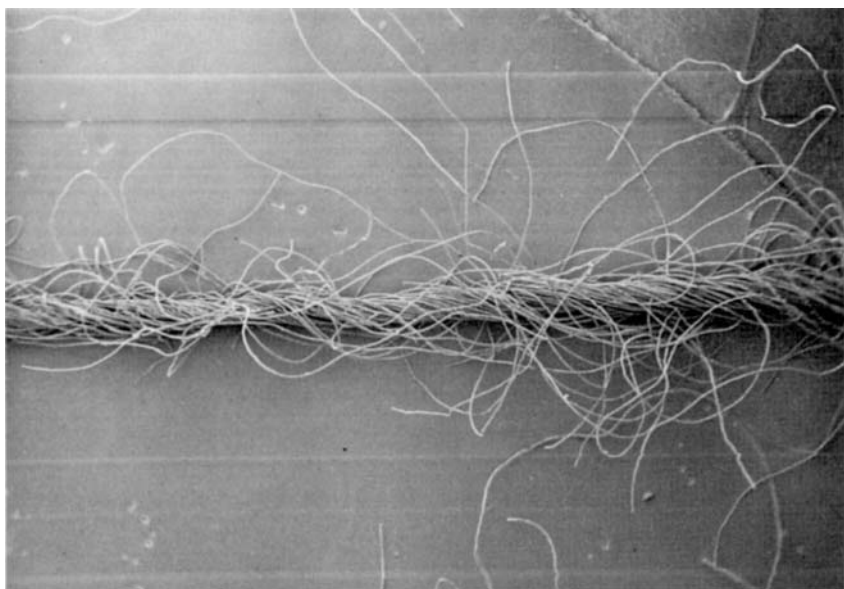

4.19 A hairy yarn $\times 15$.

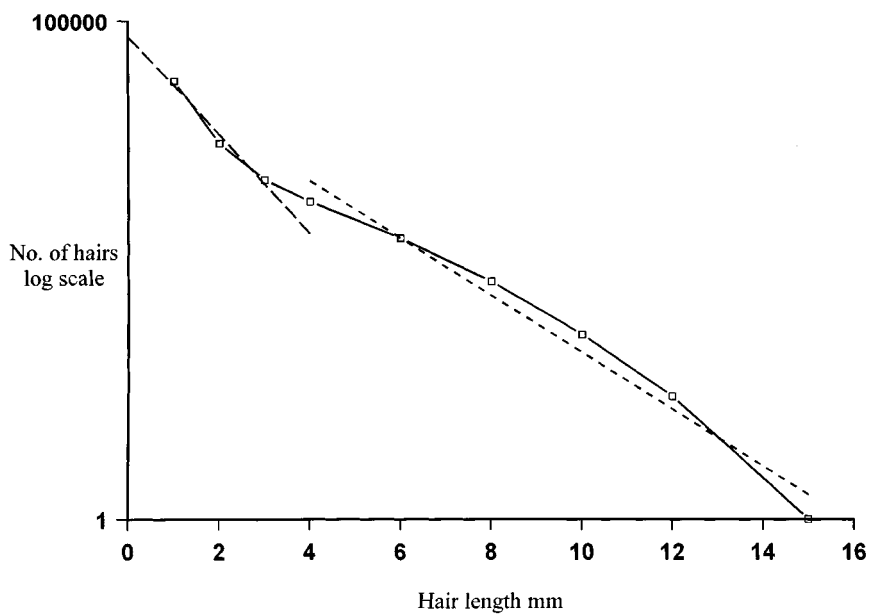

4.20 A plot of number of hairs against hair length.

linearly related to the count of the yarn, that is there are more hairs in a fine yarn than there are in a coarse one of the same type. The overall number of hairs is influenced among other things by the spinning system and by the fibre length.

Measurements of hairiness are very dependent on the experimental configuration used such as the number and type of guides the yarn passes over and also the method chosen for detecting the hairs.

4.4.1 Shirley yarn hairiness tester

The Shirley yarn hairiness tester consists of a light beam shining on a small diameter photoreceptor opposite to it. The yarn under test is run between the light and the receptor at a constant speed. As a hair passes between the light and receptor the light beam is momentarily broken and an electronic circuit counts the interruption as one hair. The instrument has two sets of yarn guides as shown in Fig. 4.21. The lower set leads the yarn over a guide at a fixed distance of 3 mm from the receptor. The upper set leads the yarn over a movable guide which can be set at a distance of between 1 and 10 mm from the receptor. The total number of hairs in a fixed length of yarn is counted by counting for a given time, the yarn running at a known speed.

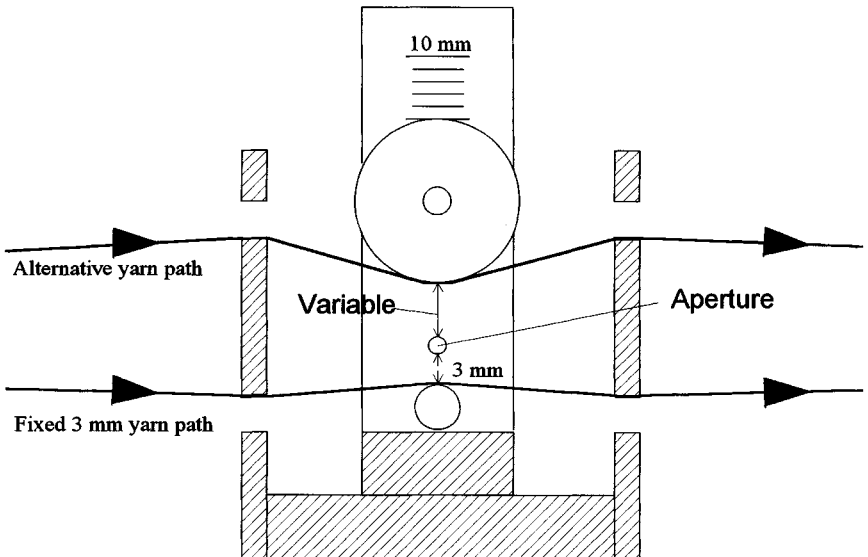

4.21 Shirley yarn hairiness.

4.4.2 Zweigle G565

This apparatus counts the number of hairs at distances from 1 to 25 mm from the yarn edge. The hairs are counted simultaneously by a set of photocells which are arranged at 1, 2, 3, 4, 6, 8, 10, 12, 15, 18, 21 and 25 mm from the yarn as is shown diagrammatically in Fig. 4.22. The yarn is illuminated from the opposite side from the photocells and as the yarn runs past the measuring station the hairs cut the light off momentarily from the photocells, which causes the electrical circuits to count in a similar manner to that of the Shirley instrument. The instrument measures the total number of hairs in each length category for the set test length. The yarn speed is fixed at 50 m/min but the length of yarn tested may be varied. The zero point, that is the position of the yarn edge relative to the photocells, is adjusted while the yarn is running by moving the yarn guides relative to the photocells. A further set of photocells is used to locate the edge of the yarn during the setting up procedure. The instrument calculates the total number of hairs above 3 mm in length which can be used as a comparison with the Shirley instrument. It also computes a hairiness index [13] which has been

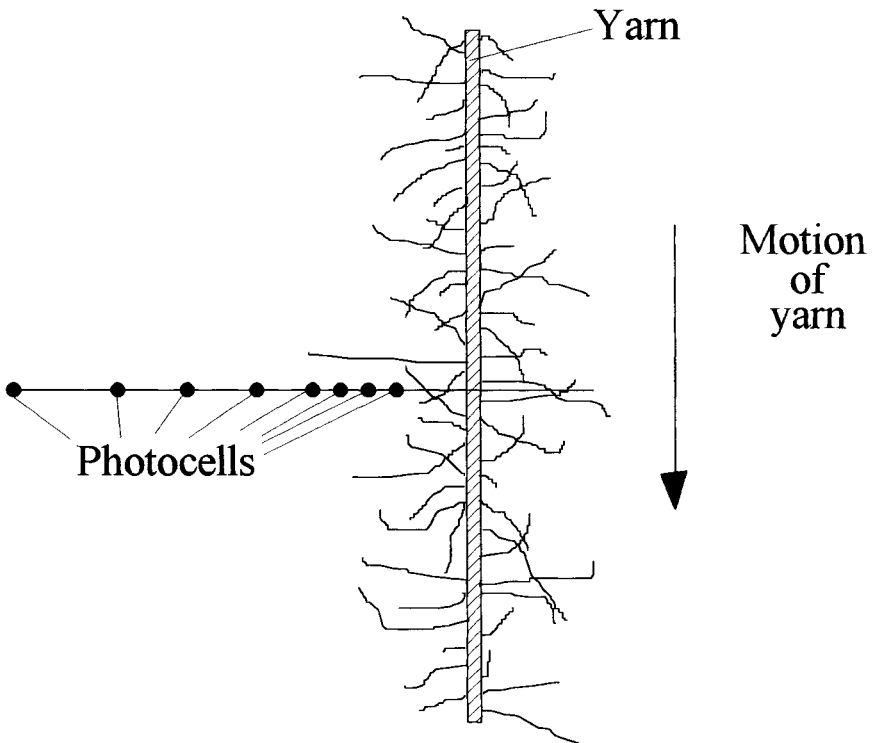

4.22 Zweigle yarn hairiness.

especially devised for this instrument and which is intended to combine all of the information measured by it.

4.4.3 Uster tester 3 hairiness meter attachment

This device is produced as an attachment for the Uster evenness tester and is connected in place of the normal measuring capacitor. However, it makes use of the full statistical result collection capabilities of the evenness instrument. The principle of the measurement is quite different from the above instruments and therefore the results from the two types of instrument are not comparable. In this instrument the yarn is illuminated by a parallel beam of infra-red light as it runs through the measuring head. Only the light that is scattered by fibres protruding from the main body of the yarn reaches the detector as is shown in Fig. 4.23. The direct light is blocked from reaching the detector by an opaque stop. The amount of scattered light is then a measure of hairiness and it is converted to an electrical signal by the apparatus. The instrument is thus monitoring only total hairiness, but using the Uster evenness data collection system can monitor changes in hairiness along the yarn by means of a diagram, spectrogram, CV of hairiness, and mean hairiness in a manner similar to that used in evenness testing.